



Response to Request for Proposal (“RFP”)  
to Equalis Group  
for the *Lighting Products and Services RFP (“R10-1133”)*

by:



Provided to:



Equalis Group

March, 3<sup>rd</sup> 2022



March 3<sup>rd</sup>, 2022

Equalis Group  
5550 Granite Pkwy, Suite 298  
Plano, TX 75024

RE: Request for Proposal for the Lighting and Products and Services

To whom it may concern;

Thank you for your consideration in allowing Aquila Environmental, LLC (“Aquila”) the opportunity to apply for this contract. As requested in your RFP due March 3<sup>rd</sup>, 2022, herein you will find the following information:

- References
- Project management structure and experience
- Staffing structure of the company
- Bond capacity for savings
- Pricelist and catalog
- Completed projects

To lead in by highlighting our history; Aquila is based in Fort Worth, Texas and is the new creation of a formerly acquired LED lighting business (“Oldco”) that was originally founded in 2005. Oldco was an early mover in the LED retrofit space having converted properties such as the Four Seasons Las Colinas in 2012 and the Gaylord Texan Resort in 2010, until it was acquired by our current ownership in the beginning of 2015. Upon being acquired and substantially recapitalized by current ownership, this led to Aquila being a pioneer in the Lighting as a Service (“Laas”) sector, whereas Aquila could internally finance LED retrofits on behalf of its customers. More particularly, Aquila could execute projects without customers having to tender \$1 up front, use the guaranteed energy savings to pay for the project, and in all cases share in the energy savings through the performance period. Under such construct, since 2015, Aquila has completed approximately 40 private sector LaaS projects (across the US) and 32 Independents School District (“ISD’s”) LaaS (energy savings performance contracts) projects in the state of Texas. With our global supply chain relationships, and substantial capitalization we have the ability to provide high-quality / low-cost engineered solutions for companies, institutions, and non-profits throughout the United States. Furthermore, we are confident given our operating history and what our references will have to say about our model and standard of work, that we are a qualified candidate to be selected for this Equalis classification.

509 Pecan Street, Suite 200  
Fort Worth, TX 76102

**AQUILA**  
ENVIRONMENTAL



Sincerely,

John Sledge  
Founder & President  
Aquila Environmental, LLC

Enclosed:

- Exhibit "A" – RFP Responses
- Exhibit "B" – Summary of Goods & Services
- Exhibit "C" – Team Overview
- Exhibit "D" – Surety Letter
- Exhibit "E" – Pricelist and Catalog
- Exhibit "F" – Completed Projects



## Exhibit "A" – RFQ Responses





1. *References that have entered a LED Lighting Retrofit contract*

Lance Rainey  
Chief Financial Officer  
Melissa ISD  
Region 10  
W: 972-369-6385  
[lrainey@melissaisd.org](mailto:lrainey@melissaisd.org)



Bryan Ritchey  
Director of Operations  
Seminole ISD  
Region 17  
W: 432-758-3662  
[britchey@seminoleisd.net](mailto:britchey@seminoleisd.net)

Jay Lashaway  
Chief Financial Officer  
[jlashaway@seminoleisd.net](mailto:jlashaway@seminoleisd.net)



Frank Molinar  
Superintendent  
White Settlement ISD  
Region 11  
W: 817-367-1300  
[fmolinar@wsisd.net](mailto:fmolinar@wsisd.net)

David Bitters  
Assistant Superintendent of  
Finance & Operations  
[dbitters@wsisd.net](mailto:dbitters@wsisd.net)





Dr. Rich Dear  
Superintendent  
Godley ISD  
Region 11  
W: 817-389-2536  
cdear@godleyisd.net

Bryan Myres  
Executive Director - Finance  
bmyres@godleyisd.net  
817-592-4161



Lance Terrell  
Ex-Chief Financial Officer  
Levelland ISD  
Region 17  
C: 806-367-0085



## *2. Project management structure and experience*

Aquila currently subcontracts the labor on projects out to our network of labor partners. Our labor partners have an in-depth team of management including the 1) president, 2) project manager and 3) crew leads. Aquila also has an internal team of management including the 1) president, 2) executive vice president, 3) managing director of operations, 4) director of project engineering and 5) dedicated project coordinators. This structure of management escalates to the ownership level of each respective organization to ensure that any high-level issue is solved with the utmost excellence. Aquila has a dedicated managing director of operations that focuses solely on managing projects. He works with the customer and labor partner on a daily basis to ensure customer satisfaction and paramount quality control.

Aquila's project cycle includes an on-site kick off meeting, daily job reports, multiple quality control site visits and a punch walkthrough. The on-site kick off meeting is held in order to facilitate starting the project and is held between the Aquila managing director of operations, the labor partner project manager, the labor partner crew leads and the customer. Once install begins, the labor partner turns in daily reports showing the portion of the scope of work completed to the Aquila managing director of operations. The Aquila project coordinator performs multiple on-site quality control inspections where fixtures are closely inspected to ensure excellent workmanship. The final step in the project is the punch walkthrough where the project is closely inspected by all parties and signed off to be substantially complete. All punch items are resolved in a timely manner following the walkthrough.

509 Pecan Street, Suite 200  
Fort Worth, TX 76102

**AQUILA**  
ENVIRONMENTAL



Aquila upholds all labor partners to contract deadlines and has always finished projects in a timely manner to customer satisfaction. Aquila typically completes projects within 1 month for small to medium size districts and within 2 months for larger districts.



### *3. Staffing structure of the company*

Aquila has a high level of salaried staff members that ensure all projects are performed to the highest level of excellence. Each specific role at Aquila is detailed below. Exhibit “C” details a one pager illustrating all staff members.

Aquila has an excellent relationship with a 3<sup>rd</sup> party PE. Imran Syed is a PE and is employed by SourceHOV Tax – Exela Technologies. They are located at 4150 International Plaza #650, Fort Worth, TX 76109. Aquila has worked with Imran since 2018, and he has professionally endorsed many of our past projects including: White Settlement ISD, Godley ISD, Levelland ISD and Melissa ISD. His Texas PE license number is 110338. His email is [imran.syed@exelaonline.com](mailto:imran.syed@exelaonline.com) and his phone number is 214-830-5694.

- John Sledge – Founder & President
  - Leads all executive functions and the long-term vision of the company
  - 13 years of investing in, owning, and operating multiple businesses
  - Has participated as Principal/Managing Partner in excess of \$70MM worth of transactions
- James Coston – Executive Vice President, C.E.M.
  - Manages day to day functions of the company
  - 10 years’ experience in the management of energy efficiency / ESCO / energy savings performance contract businesses
- Alan Johnston – Vice President, Sales
  - Manages the sales department
  - 17 years’ experience in sales
- Kent Mire – Managing Director of Operations
  - Manages all projects
  - 7 years’ experience in management
- Chandan Prasai – Director of Project Engineering
  - Manages the project engineering silo
  - 6 years of energy efficiency operations experience
- Tito Cotto – Director of Auditing & Technology
  - Manages the auditing silo
  - Focuses solely on auditing projects & performing measurement and verification
  - 7 years of energy efficiency operations experience
- John Hebert – Director of Relationship Management
  - Oversees all customer relationships
  - Retired Texas public school superintendent
  - 18 years of administration experience in the Texas public school system
- Maddy Goodwin – Office Administrator



- Manages all office functions
  - 8 years of office administration experience
- Kerry Byrd – CPA – Controller
  - Manages all accounting functions
  - 15 years of accounting experience
- Dewayne Furr – Project Coordinator
  - Focuses solely on projects in the field
  - 24 years of management experience
- Johnny James – Master Electrician
  - Staff Master Electrician
  - 35 years of electrical experience
- Mike Flynn – Field Representative
  - Assists operations with field duties

#### *4. Bond capacity for savings*

Aquila has the ability to bond savings through a 3<sup>rd</sup> party surety company. Exhibit “D” details the letter from our surety company.



## Exhibit "B" – Summary of Goods and Services

## What is Aquila Environmental?

- Texas-based Lighting as a Service Company (“LaaS”) - turnkey LED lighting project developer that delivers retrofits at \$0 up front cost (engineering / procurement / installation / financing / warranty management)
- Project Finance Bank – offer proprietary financing vehicles that allow ISD’s to implement energy conservation projects that ‘cash-flow’ day 1 without having to allocate any of their budgeted capital
- International / ‘OEM direct’ supply lines - means no ‘private label’ or ‘distributor’ markup, which allows Aquila to procure technology on behalf of its customers at ~40% of normal cost

### Project Composition for ISD’s

- Total interior lighting retrofit to LED (troffer lights / can lights / accent lights / etc)
  - Gymnasium high bay lighting re-fixture to LED
  - Exterior lighting re-fixture to LED (wall packs / parking lot post lights / ground lighting)
  - Some special lighting conversions to LED (other sports lighting / decorative lighting / event lighting / etc)
  - Emergency Backup systems (“EBU”) replacement
- \*virtually the entire school district will be converted to LED*

### Key Takeaways

- Zero capital outlay to consummate project
- Cash flow positive day one of project implementation
- Aquila offers turn-key & in-house solution through entire project cycle (audit / procurement / rebate / financing / installation / warranty management)
- Entire district will be converted to LED with zero anticipated lighting maintenance for a period of ~20 years
- No residual fees following project payout



START





## Exhibit "C" – Team Overview





John Sledge – President/Founder



Alan Johnston – Vice President of Sales



James Coston – Executive Vice President



John Hebert – Director of Relationship Management



Kerry Byrd – Controller



Kent Mire – Managing Director of Operations



Chandan Prasai – Director of Project Engineering



Tito Cotto – Director of Auditing & Technology



Dewayne Furr – Operations Associate



Maddy Goodwin – Office Administrator



## Exhibit "D" – Surety Letter



**All American Insurance Associates**  
**Managing Risk & Protecting**  
**Assets Since 1973**

January 20, 2022

Re: Aquila Environmental LLC

To Whom It May Concern,

Insurors Indemnity Company is the current bonding company for the above contractor and is working with our insured to provide for their bonding needs. The insurance company would favorably consider any request provided they have met all underwriting conditions at the time of the request and they are presented with an acceptable contract. We consider Aquila Environmental LLC to be an excellent contractor and would recommend them highly for your project. This contractor currently has a 2M aggregate bonding program in force that can be adjusted upward depending on the project size.

Any arrangement for bonds required by a contract are a matter between the principal and the surety and we assume no liability to you or third parties, if for any reason we do not execute said bonds or if circumstances change after the date of this letter. Insurors Indemnity Company is currently rated A- (Excellent) by AM Best Company and is on the US Department of Treasury's list of approved sureties for federal work (T-List). They are domiciled in the State of Texas and licensed with the Texas Department of Insurance to write bonds in the state of Texas.

If you should have any further questions, please do not hesitate to give me a call @ 817-573-2118.

Sincerely,

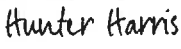
DocuSigned by:  
  
4B3519D63BA8493...

K. Hunter Harris  
Vice President  
All American Insurance Associates



## ADDITIONAL COVERAGES

Ref #	Description PIP-Basic	Coverage Code PIP	Form No.	Edition Date
Limit 1 2,500	Limit 2	Limit 3	Deductible Amount	Deductible Type
Premium				
Ref #	Description Products/Completed Ops Aggregate	Coverage Code PRDCO	Form No.	Edition Date
Limit 1 2,000,000	Limit 2	Limit 3	Deductible Amount	Deductible Type
Premium				
Ref #	Description Umbrella(C)	Coverage Code CUMBR	Form No.	Edition Date
Limit 1	Limit 2	Limit 3	Deductible Amount	Deductible Type
Premium				
Ref #	Description	Coverage Code	Form No.	Edition Date
Limit 1	Limit 2	Limit 3	Deductible Amount	Deductible Type
Premium				
Ref #	Description	Coverage Code	Form No.	Edition Date
Limit 1	Limit 2	Limit 3	Deductible Amount	Deductible Type
Premium				
Ref #	Description	Coverage Code	Form No.	Edition Date
Limit 1	Limit 2	Limit 3	Deductible Amount	Deductible Type
Premium				
Ref #	Description	Coverage Code	Form No.	Edition Date
Limit 1	Limit 2	Limit 3	Deductible Amount	Deductible Type
Premium				
Ref #	Description	Coverage Code	Form No.	Edition Date
Limit 1	Limit 2	Limit 3	Deductible Amount	Deductible Type
Premium				
Ref #	Description	Coverage Code	Form No.	Edition Date
Limit 1	Limit 2	Limit 3	Deductible Amount	Deductible Type
Premium				
Ref #	Description	Coverage Code	Form No.	Edition Date
Limit 1	Limit 2	Limit 3	Deductible Amount	Deductible Type
Premium				

*Rick Figueroa*  
Chair

*Thomas F. Butler*  
Vice Chair



*Gerald R. Callas, M.D., F.A.S.A.*  
*Helen Callier*  
*Joel Garza*  
*Gary F. Wesson, D.D.S., M.S.*  
*Nora Castañeda*

## *Electrical Contractor*

**AQUILA ENVIRONMENTAL LLC**

License Number: 33359

The business named above is licensed by the Texas Department of Licensing and Regulation

License Expires: MARCH 09 2022

Brian E. Francis  
Executive Director



## Exhibit "E" – Pricelist and Catalog



## Pricing Sheet & Catalog

© 2022 Aquila Environmental, LLC – Confidential

509 Pecan Street, Suite 200, Fort Worth, TX 76102  
817-953-3171  
[www.aquilaenv.com](http://www.aquilaenv.com)





Area Light (AR140UT4-50BARPC + PCTL-UNV)	\$486.55
Wall Pack (WP-OP50U-50BPC)	\$136.99
Troffer Kit (TRK-22D2340)	\$96.06
Troffer Kit (TRK-24D3340)	\$108.52
Highbay (BLHE2-178DUF-50 + BLHE-WGW)	\$193.92
A19 (E9A19DLED40/G8)	\$2.99
Bypass Tube (L11.5T8DE440-CG4)	\$9.17
Exit Sign (EX-RW)	\$25.81
Corn Lamp (54PT50EX39)	\$93.34
BR30 (8BR30DLED40/G3)	\$6.34
4PIN (8PLG24QCS)	\$15.42
Hybrid Tube (L12T8AB440-CG)	\$12.71
Labor – Lighting Install	\$65/HR
Lighting Audit	\$0.03/SF

## LED SLIM AREA LIGHTS AR SERIES, GENERATION 2

Fixture shown with  
Slipfitter Knuckle

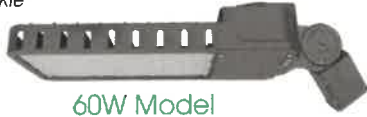

Fixture shown with  
Trunnion Swivel



Fixture shown with  
Straight Arm



### FEATURES:

- Trade Agreements Act (TAA) compliant product available - Contact MaxLite for details
- Replaces up to 750W MH/HPS equivalent
- Universal 120-277V dimming driver standard, 347-480V available
- Dusk-to-dawn and occupancy sensor capability
- Meets ANSI 3G vibration standard for bridges and overpasses
- 10kV surge suppression standard
- Comes with 41" 18/3 SO cord

### MOUNTING:

- 7.5" Straight Arm<sup>1</sup>
- Trunnion Swivel
- 2-3/8" Slipfitter Knuckle

### WARRANTY:

10-year standard warranty with labor allowance\*  
(further details available at [www.maxlite.com/warranties](http://www.maxlite.com/warranties))

\*Warranty Limitations: Product must be rated for the application per the Product Data Sheet (PDS); operated ≤16 hrs/day; in ambient of -29°F to 104°F. \*Up to \$25/unit; labor allowances of up to \$500/unit available for purchase – contact MaxLite representative for details.

### CONTROLS:

**PC Option:** NEMA standard C136.41 3-Pin twist lock receptacle for use with NEMA twist lock photocell. **The photocell is sold separately.**

**Photo/Motion Sensor:** The FSP-211 uses passive infrared (PIR) sensing technology to react to changes in infrared energy (i.e. moving body heat) within the coverage area. This slim, low-profile sensor is designed for installation inside the bottom of a light fixture body and is ideal for outdoor environments. The sensor operates at 120V/230V-240V and single phase 277V. The motion sensor is fully adjustable with high and low dimmed light level options with optional dusk to dawn control. Sensor can be combined with various lenses to operate at mounting heights from 8' to 40'. Please refer to page 4 for the sensor's factory default settings. Factory settings can be adjusted via the FSIR-100, a wireless configuration tool. **Note that the sensor comes with photocell setting disabled and the FSIR-100 must be purchased if photocell functionality is desired.**

Please refer to the FSP-211 Supplementary Datasheet for more product information.

**DIMENSIONS:** Please see page 3 and 4 for dimension drawings.

### PRODUCT DESCRIPTION:

The LED Slim Area Lights deliver class-leading efficacy in a lightweight design that can be effortlessly applied to new and retrofit outdoor projects. Offered in lumen packages ranging from 7,700lm to over 35,000lm, the AR Series achieves up to 130 lumens per watt while providing significant long-term energy and maintenance cost savings.

## MaxLite Makes It!

Don't see what you need? Additional wattages and specifications available upon request - contact your MaxLite rep!

### MODEL SELECTION

Typical order example: AR60UT5-50BK

AR									
FAMILY	NOMINAL WATTAGE	VOLTAGE	DISTRIBUTION	CCT	FINISH	MOUNTING	OPTIONS		
AR= Area Light	<b>60=</b> 60W, 250W MH/HPS equivalent <b>100=</b> 100W, 400W MH/HPS equivalent <b>140=</b> 140W, 400W MH/HPS equivalent <b>210=</b> 210W, 750W MH/HPS equivalent <b>280=</b> 280W, 750W MH/HPS equivalent	<b>U=</b> 120-277V <b>H=</b> 347-480V	<b>T2=</b> Type II <b>T3=</b> Type III <b>T4=</b> Type IV <b>T5=</b> Type V	<b>40=</b> 4000K <b>50=</b> 5000K	<b>B=</b> Bronze  <i>Contact MaxLite for additional finishes</i>	<b>A=</b> Straight Arm <sup>1</sup> <b>K=</b> 2-3/8" Slipfitter Knuckle <b>T=</b> Trunnion Swivel	<b>(OMIT)=</b> None <b>MS=</b> Daylight/Motion Sensor <b>RPC=</b> NEMA 3-pin receptacle (NEMA twist lock Photocell sold separately) <b>PR7=</b> NEMA 7-Pin receptacle (control module sold separately)		

### NOTES:

<sup>1</sup> The straight arm mounting fits square poles. For compatibility with round poles, combine the straight arm mounting with a round pole adaptor. See adaptor selection table on page 3.

**SPECIFICATIONS:**

SPECIFICATIONS:			60 WATT	100 WATT	140 WATT	210 WATT	280 WATT	
ITEM	SPECIFICATION		DETAILS					
<b>GENERAL PERFORMANCE</b>	Input Power (W)		60W	100W	140W	210W	280W	
	Type II	4000K	Lumens	7846	12420	17014	25633	34547
			BUG Rating	B3-U0-G3	B3-U0-G3	B3-U0-G3	B3-U0-G3	B3-U0-G3
		5000K	Lumens	7860	12675	17922	26756	35886
			BUG Rating	B3-U0-G3	B3-U0-G3	B3-U0-G3	B3-U0-G3	B3-U0-G3
	Type III	4000K	Lumens	7900	12420	17014	25663	34547
			BUG Rating	B3-U0-G3	B3-U0-G3	B3-U0-G3	B3-U0-G3	B3-U0-G3
		5000K	Lumens	7900	12675	17922	26756	35886
			BUG Rating	B3-U0-G3	B3-U0-G3	B3-U0-G3	B3-U0-G3	B3-U0-G3
	Type IV	4000K	Lumens	7615	12421	17015	25663	34548
			BUG Rating	B3-U0-G3	B3-U0-G3	B3-U0-G3	B4-U0-G4	B5-U0-G5
		5000K	Lumens	7699	12675	17922	26756	35886
			BUG Rating	B3-U0-G3	B3-U0-G3	B3-U0-G3	B4-U0-G4	B5-U0-G5
	Type V	4000K	Lumens	7787	12420	17014	25663	34547
			BUG Rating	B3-U0-G1	B3-U0-G1	B3-U0-G1	B3-U0-G1	B3-U0-G1
		5000K	Lumens	7860	12675	17922	26756	35886
			BUG Rating	B3-U0-G1	B3-U0-G1	B3-U0-G1	B3-U0-G1	B3-U0-G1
	Efficacy (lm/W)		up to 130 lm/W					
	CRI		> 70					
	Lumen Maintenance (L90, TM21 @ 25°C)		> 100,000 hours					
Color Temperature		4000K and 5000K available						
Power Factor		> 0.9						
THD		< 16%						
<b>ELECTRICAL</b>	Input Voltage Range		120-277V standard, 347-480V available					
	Housing		Die-cast aluminum					
	Lens		Polycarbonate lens					
<b>PHYSICAL</b>	Housing		2-3/8" Slipfitter, Straight Arm, Trunnion Swivel					
	Lens		Type II, Type III, Type IV, Type V - Frosted lens					
	Mounting		Slip Fitter, Straight Arm, Trunnion Mount options					
	Dimensions (Module)		15.9"x8.7"x3.4"	16.9" x 10.3" x 3.4"		16.6" x 15.0" x 3.5"		
	Weight		8.5 lbs	11.8 lbs	12.5 lbs	22.5 lbs	23.9 lbs	
	EPA (sq. ft) 0°/90°		0.43/1.34	0.43/1.64		0.49/2.26		
	Operating Temperature		-40°F to 131° F (-40°C to 55°C)					
<b>CERTIFICATION</b>	Certifications		cULus, supports T24 compliance, FCC					
	Material Usage		RoHS compliant; no mercury					
	Environment		Outdoor, Wet location, IP65 rating, 3G Vibration					
	Warranty		10-year standard warranty*					
<b>QUALIFICATION</b>	DesignLight Consortium		DLC Premium					

**ACCESSORIES:**

ORDER CODE	MODEL	DESCRIPTION
107846	AR-MAL-4RPA	4" Round Pole Adaptor for AR-MAL Series, to be used with straight arm
107847	AR-MAL-5RPA	5" Round Pole Adaptor for AR-MAL Series, to be used with straight arm
105038	PCTL-UNV	NEMA Twist-Lock Photocontrol 120/208/240/277V
1408292	6394LL	NEMA Twist-Lock Photo Control 347V-480V
96268	MLRTLPCRSP	Shorting Cap Photocontrol 3 Pin NEMA Rotatable Twist Lock
103658	AR-S-HS-GEN2-B	House Side Shield for AR GEN 2 Series, Bronze Finish, Small Size compatible with 60W/100W/140 Models
1408946	AR-MAL-L-HS-B	House Side Shield for AR-MAL Series, Bronze Finish, Large Size compatible with 210W/280W Model
102944	UPMA-B	Universal Pole Mount Adaptor, Bronze, hardware and gasket included
102945	UPMA-S	Universal Pole Mount Adaptor, Silver, hardware and gasket included
102225	UPMA-4RPA-B	Round Pole Adaptor for 4" pole for Universal Pole Mount Adaptor
102976	UPMA-5RPA-B	Round Pole Adaptor for 5" pole for Universal Pole Mount Adaptor
102184	FSIR-100	Remote Handheld Configuration Tool

**DIMENSIONS:**

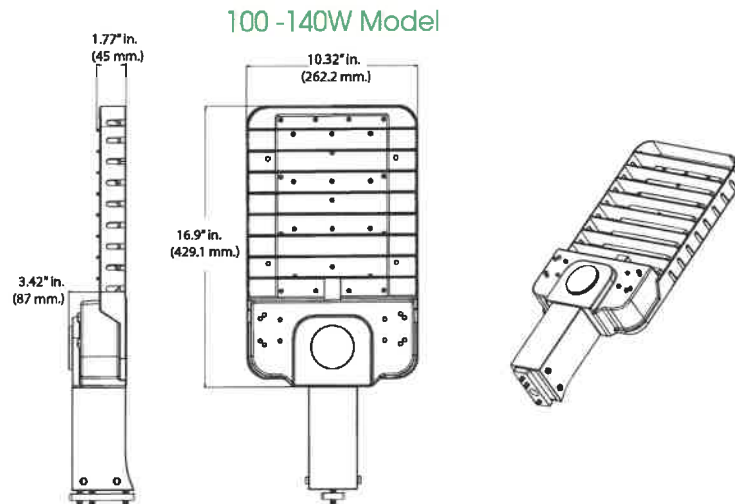
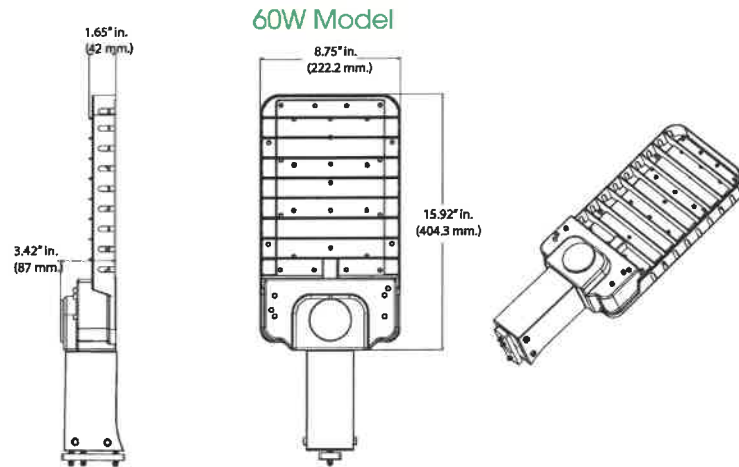



**DIMENSIONS:**

210-280W Model

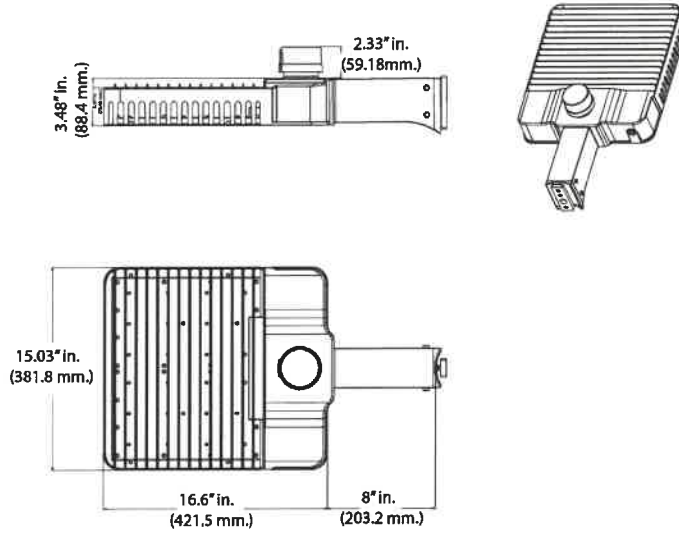

**MOUNTING DIMENSIONS:**

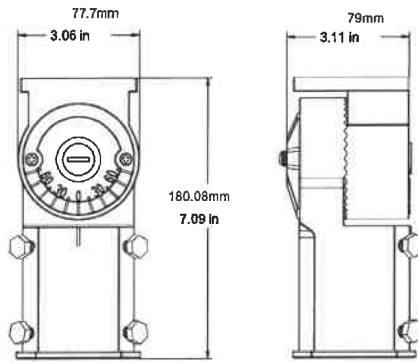

Slip Fitter Knuckle

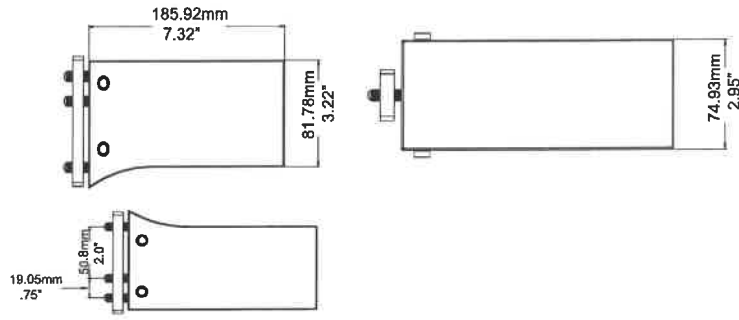

Straight Arm

Trunion Swivel

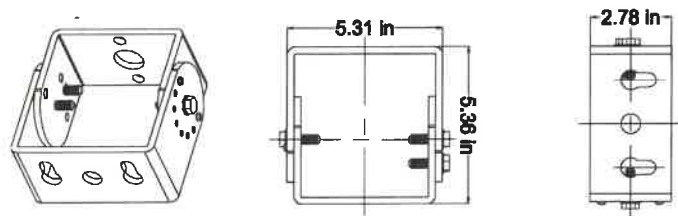

## WALLMAX™ OPEN FACE WP-OP Series



### DIMENSIONS:

SIZE 1 - 28W & 40W

SIZE 2 - 28W, 40W, 50W, 80W & 120W

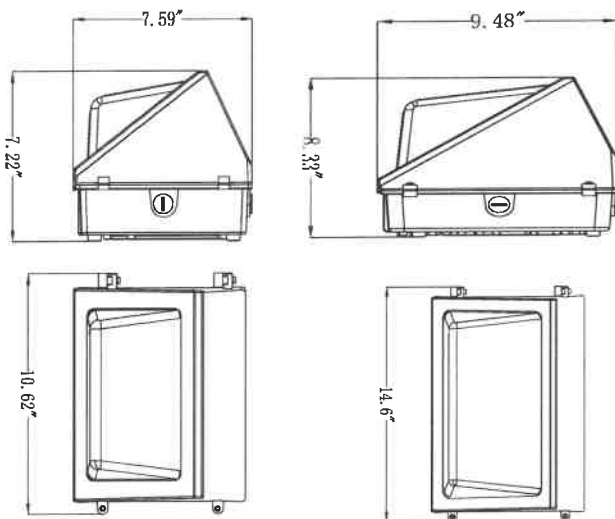

### PRODUCT DESCRIPTION:

WallMax™ Open Face Wall Packs are ideal for brightly-lit outdoor environments in parking garages, entrances, public areas, schools, hospitals, hotels and outdoor walkways nationwide. The 28-, 40-, 50-, 80-, and 120-watt LED fixtures are energy-efficient replacements for up to 750-watt metal halide fixtures. The fixtures are rebatable, save energy, generate lower maintenance costs, and prevent light pollution.

### FEATURES:

- Trade Agreements Act (TAA) compliant product available - Contact MaxLite for details
- Heavy-duty cast aluminum housing is polyester powder coated to be rust and corrosion proof
- Shatter-resistant borosilicate glass
- 0-10V dimming driver standard
- 6kV integral surge suppression standard
- Six ½ NPS knockouts available
- Photo/Motion Sensor, 347-480V, Battery Back-Up options, Visors and Wire Guards available.

### CONTROLS:

#### 120-277VAC Photocontrol:

- Power the fixture when light levels reach 20 lux or below
- Turn off the fixture at 30 lux or higher

#### PIR Outdoor Daylight/Motion Sensor:

- Sensor provides multi-level control based on motion and/or daylight contribution for 0-10V DC Drivers
- All control parameters are adjustable remotely
- At least one FSIR-100 remote control must be ordered per project to be able to adjust factory settings for daylight / motion sensor
- For more information, please see supplementary datasheet for sensor model [MSWSFSP221B>>>](#)

### WARRANTY:

10-year standard warranty with labor allowance\*

(further details available at [www.maxlite.com/warranties](http://www.maxlite.com/warranties))

\*Warranty Limitations: Product must be rated for the application per the Product Data Sheet (PDS); operated ≤16 hrs/day; in ambient of -29°F to 104°F.

\*Up to \$25/unit; labor allowances of up to \$500/unit available for purchase – contact MaxLite representative for details.

## MaxLite Makes It!

Don't see what you need? Additional wattages and specifications available upon request - contact your MaxLite rep!

MODEL SELECTION		Typical order example: WP-OP28U-50B				
WP-OP					B	
FAMILY	WATTAGE	VOLTAGE		LED MODULE	FINISH	OPTION
WP-OP= Open Face Wall Pack	28= 28W, 150W MH replacement 40= 40W, 175W MH replacement 50= 50W, 250W MH replacement 80= 80W, 400W MH replacement 120= 120W, 750W MH replacement	U= 120-277V H= 347-480V	-	40= 4000K, CRI 80+ 50= 5000K, CRI 80+	B= Bronze Contact MaxLite for additional finishes	(BLANK)= None PC= 120-277V Photocontrol MS= PIR Daylight/Motion Sensor L= Size 2 housing EM2= Size 2 housing, Battery Backup, -20° C EM0= Size 2 housing, Battery Backup, 0° C

1. Not DLC listed. Not available with LEM2 or LEM0 options.  
2. Motion Sensor performs at 20' up to 48' diameter. External model MSWSFSP221B-D will be provided on models with 120W; 347-480V; or -20 C Battery back up.  
3. Use with 28W and 40W fixtures only.  
4. Option L must be used with options EM0 and EM2 for all wattages.

ACCESSORIES			
ORDER CODE	MODEL NUMBER	DESCRIPTION	ACCESSORIES IMAGE
100679	WP-OP-S1PLATE-B	Beauty Plate, 14.50" X 9.50" X 0.08", Size 1, Bronze, 28W and 40W Models	
100461	WP-OP-S2PLATE-B	Beauty Plate, 18.1" * 8.7" * 0.08", Size 2, Bronze, 50W, 80W, and 120W Models	
102184	FSIR-100	Remote Control for daylight / motion sensor	
100821	WP-OP-S1VISOR-B	Cutoff Visor, Size 1, Bronze, 28W and 40W models	
100822	WP-OP-S2VISOR-B	Cutoff Visor, Size 2, Bronze, 50W, 80W and 120W models	
14099860	WP-OPSWG	Wire Guard, Size 1, Bronze, 28W and 40W models	
101499	WP-OPLWG	Wire Guard, Size 2, Bronze, 50W, 80W and 120W models	

**SPECIFICATIONS:**

ITEM	SPECIFICATION	28W	40W	50W	80W	120W
		DETAILS				
<b>GENERAL PERFORMANCE</b>	Input Power (W)	28	40	50	80	120
	Lumens Delivered (up to)	3,770	5,645	7,065	11,375	16,945
	Efficacy (up to)	136	138	138	140	140
	CRI	≥80				
	Lumen Maintenance (L85, TM-21 @ 25°C)	>100,000 hours				
	Color Temperature	4000K, 5000K				
	Spacing Criteria	Available upon request				
<b>ELECTRICAL</b>	Input Voltage	120-277V standard; 347-480V available				
	Power Factor	>90%				
	THD	<15%				
<b>PHYSICAL</b>	Housing	Die-Cast Polyester Aluminum				
	Lens	Shatter-resistant borosilicate glass				
<b>CERTIFICATION</b>	Certifications	ETL, IP65				
	Environment	Outdoor, wet location				
	Warranty	10-year standard warranty*				
	Operating Temperature	-40°F ~ 104°F (-40°C ~ 40°C)				
<b>QUALIFICATION</b>	Humidity	10%-90% RH, non-condensing				
	DesignLight Consortium	DLC Premium				

Lighting layouts and spacing criteria available upon request.

**LAYOUTS:**

**WP-OP 28W:**

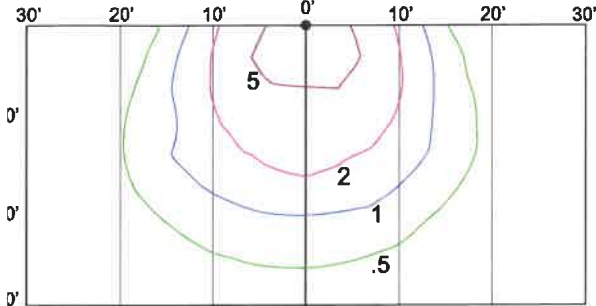

**28W**  
3,640 LUMENS (SIZE 1 HOUSING)  
10' MOUNTING HEIGHT

FOOT-CANDLE CORRECTION FACTOR:

NEW HEIGHT:	10'	15'	20'	25'
MULTIPLY BY:	1	0.67	0.50	0.40

**WP-OP 40W:**

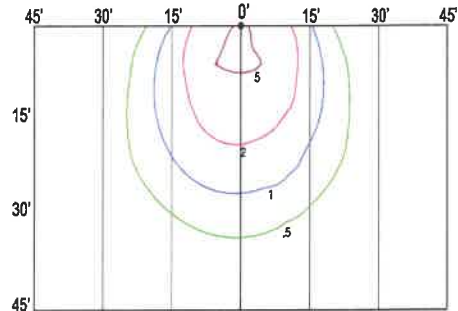

**40W**  
5,540 LUMENS (SIZE 1 HOUSING)  
15' MOUNTING HEIGHT

FOOT-CANDLE CORRECTION FACTOR:

NEW HEIGHT:	10'	15'	20'	25'
MULTIPLY BY:	1.50	1	0.75	0.60

**WP-OP 50W:**

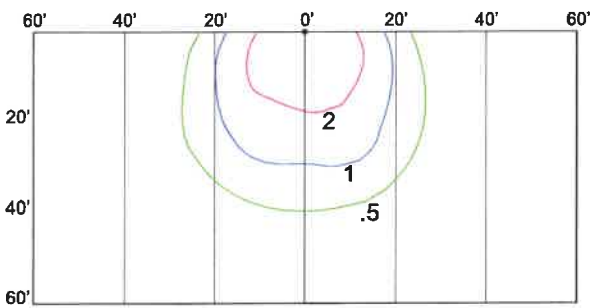

**50W**  
7,065 LUMENS  
20' MOUNTING HEIGHT

FOOT-CANDLE CORRECTION FACTOR:

NEW HEIGHT:	10'	15'	20'	25'
MULTIPLY BY:	2	1.33	1	0.80

**WP-OP 80W:**

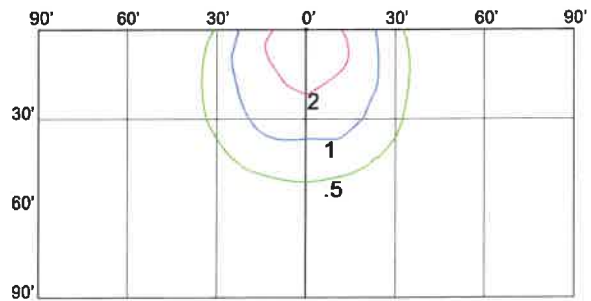

**80W**  
11,375 LUMENS  
30' MOUNTING HEIGHT

FOOT-CANDLE CORRECTION FACTOR:

NEW HEIGHT:	10'	15'	20'	25'	30'
MULTIPLY BY:	3	2	1.50	1.2	1

**WP-OP 120W:**

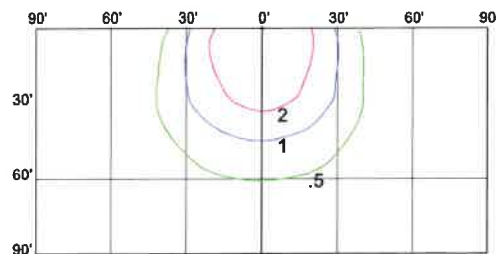

**120W**  
16,945 LUMENS  
30' MOUNTING HEIGHT

FOOT-CANDLE CORRECTION FACTOR:

NEW HEIGHT:	10'	15'	20'	25'	30'
MULTIPLY BY:	3	2	1.50	1.2	1



## LED TROFFER RETROFIT KIT TRK SERIES



### PRODUCT DESCRIPTION:

MaxLite's innovative Troffer Retrofit Kit offers an economical solution to upgrade existing fixtures to LED technology. The Troffer Retrofit kit can be retrofitted into most existing troffers in under 15 minutes. Optional trim plates can be included and are a great way to give a "clean" look to the installed fixture.



### FEATURES:

- Quick installation of Troffer Retrofit Kit in existing luminaire without the need to break the ceiling plenum
- CRI >80
- Available in 3500K, 4000K, and 5000K

### CONSTRUCTION:

- Galvanized steel body
- Reflective white finish
- Standard dimension for 1'x4', 2'x2' & 2'x4' retrofits

### CONTROL:

Compatible with standard 0-10V dimming controls

### FORM AND FIT:

MaxLite recommends that a product be tested before projects begins to check fit of the retrofit kit. The retrofit kit is designed to fit into most preexisting troffers. (lensed and parabolic)

### WARRANTY:

10-year standard warranty with labor allowance\*  
(further details available at [www.maxlite.com/warranties](http://www.maxlite.com/warranties))

\*Warranty Limitations: Product must be rated for the application per the Product Data Sheet (PDS); operated ≤16 hrs; in ambient of -29°F to 104°F.

\*Up to \$25/unit; labor allowances of up to \$500/unit available for purchase – contact MaxLite representative for details.

### ORDER STRUCTURE

FAMILY	-	SIZE	DIMMING	WATTAGE	CCT	OPTIONS
TRK= LED Troffer Retrofit Kit	-	14 <sup>2</sup> = 1'x4'	D= Dimming (0-10V)	23 <sup>1</sup> = 23W	35= 3500K 40= 4000K 50= 5000K	EM= Battery backup MS <sup>2</sup> = Bi-level motion Sensor with Daylight Harvesting – Remote commissionable
		22= 2x2'		23= 23W 33= 33W		
		24= 2'x4'				

1. <sup>1</sup>23W in 1'x4' is a special order.
2. <sup>2</sup>EM and MS options are not available in 1'x4'.
3. <sup>3</sup>MS option in 3500K and 5000K CCT are special order.
4. EM with MS (EMMS) not available

**STOCKED ITEMS**

ORDER CODE	MODEL NUMBER	DLC#	DLC CATEGORY	SIZE	WATTAGE	CCT		
14101838	TRK14D2335	PLLY042BMNZ	Indoor Retrofit Kit	1'x4'	23W	3500K		
14101839	TRK14D2340	PL90SKMJWFLB				4000K		
14101840	TRK14D2350	PLW65DBX795N				5000K		
14098888	TRK22D2335	PLQEJ14Y2QKE		2'x2'		23W	3500K	
14098889	TRK22D2340	PLC6KWO1L0AG					4000K	
14098890	TRK22D2350	PLWMPFU05ZL8					5000K	
14101841	TRK24D2335	PLSILBWN199E		2'x4'			23W	3500K
14101842	TRK24D2340	PLNK0K80S9BS						4000K
14101843	TRK24D2350	PLI18LDRZFR2						5000K
14098891	TRK24D3335	PLJCUA79J0SB			33W			3500K
14098892	TRK24D3340	PLW0G5ENV8DX						4000K
14098893	TRK24D3350	PLVXXINUCT85						5000K

**SPECIFICATIONS**

		TRK14D2335	TRK14D2340	TRK14D2350	TRK22D2335	TRK22D2340	TRK22D2350
ITEM	SPECIFICATION	DETAILS					
GENERAL PERFORMANCE	Power Consumption (W)	23W					
	Lumens Delivered (lm)	2,875 lm	2,944 lm	2,967 lm	2,957 lm	2,937 lm	2,944 lm
	Efficacy (lm/W)	125 lm/W	128 lm/W	129 lm/W	129.7 lm/W	129.9 lm/W	130.3 lm/W
	CRI	>80					
	Color Temperature (K)	3500K, 4000K, 5000K					
	THD	<20%					
	L70 Lifetime (hours)	>100,000					
	Color Consistency	Proprietary binning for uniform color					
ELECTRICAL	Power Factor	≥0.90					
	Input Voltage	120-277V					
	Dimming	0-10V, dimming up to 10%					
PHYSICAL	Operating Temperature	-4°F to 122°F (-20°C to 50°C)					
	Humidity	20-85% RH, non-condensing					
	Dimensions	47.9" x 11.9" x 3.1"			23.8" x 23.8" x 2.8"		
CERTIFICATION	Certification	cULus, FCC					
	Material Usage	RoHS compliant; no mercury					
	Environment	Damp locations					
	Warranty	10 year standard warranty					
QUALIFICATION	DesignLight Consortium	DLC 4.3 Premium					

\*L70 Lumen maintenance calculated for LED chip at max Ambient of 122°F (50°C)

**SPECIFICATIONS:**

		TRK24D2335	TRK24D2340	TRK24D2350	TRK24D3335	TRK24D3340	TRK24D3350
ITEM	SPECIFICATION	DETAILS					
GENERAL PERFORMANCE	Power Consumption (W)	23W			33W		
	Lumens Delivered (lm)	2,875 lm	2,944 lm	2,967 lm	4,145 lm	4,298 lm	4,294 lm
	Efficacy	125 lm/W	128 lm/W	129 lm/W	128.0 lm/W	132.5 lm/W	132.7 lm/W
	CRI	>80					
	Color Temperature (K)	3500K, 4000K, 5000K					
	THD	<20%					
	L70 Lifetime (hours)	>100,000					
	Color Consistency	Proprietary binning for uniform color					
ELECTRICAL	Power Factor	>0.90					
	Input Voltage	120-277V					
	Dimming	0-10V, dimming up to 10%					
PHYSICAL	Operating Temperature	-4°F to 122°F (-20°C to 50°C)					
	Humidity	20-85% RH, non-condensing					
	Dimensions	47.8" x 23.8" x 2.8"					
CERTIFICATION	Certification	cULus, FCC					
	Material Usage	RoHS compliant; no mercury					
	Environment	Damp Locations					
	Warranty	10 year standard warranty					
QUALIFICATION	DesignLight Consortium	DLC 4.3 Premium					

**ACCESSORIES:**

ORDER CODE	MODEL	DESCRIPTION	
108113	RMHYTHRC-05	REMOTE CTRL	

**LED HIGH BAY LINEAR**  
**ECO SERIES GEN 2**

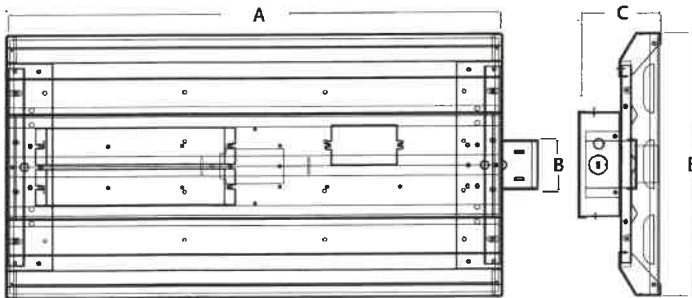
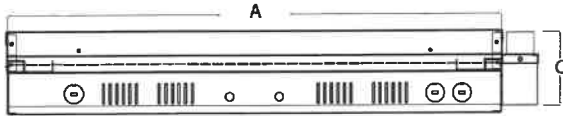

**PRODUCT DESCRIPTION:**

The Eco High Bay Series is a cost-effective and quality solution for lighting gymnasiums, warehouses, distribution centers, manufacturing facilities, big box retailers, and other commercial and industrial applications. A dimmable and compact product made of galvanized steel housing and white electrostatic powder coat finish, it delivers a high lumen output to replace both 4 or 6 lamp T5HO fluorescent highbay or 400W HID highbay fixtures. Cable, pendant and surface mounting options enable the highbay to be customized to meet virtually any lighting requirement.

**FEATURES:**

- Trade Agreements Act (TAA) and Buy American Act (BAA) compliant product available - contact MaxLite for details
- Dimmable
- Power factor >0.9
- Standard with frosted lens
- Universal voltage 120-277V and high voltage option 347-480V
- L70 lumen maintenance of 100,000 hours, L90 to meet DLC Premium
- Operating temperature: -4°F to 122°F (-20°C to 50°C)
- CCT of 4000K and 5000K with <5 step SDCM
- Surface or suspension mounted
- V-hook and 40" knotted chain included in standard model
- Suitable for Damp locations
- Operating humidity 10% to 80% RH non-condensing
- Option for cord and plugs for all voltages
- Sensor option
- 17W BBU option
- Wire guard for all sizes as accessory
- Lens material is PMMA (polymethylmethacrylate)

**WARRANTY:**

10-year standard warranty with labor allowance\* (further details available at [www.maxlite.com/warranties](http://www.maxlite.com/warranties))  
\*Warranty Limitations: Product must be rated for the application per the Product Data Sheet (PDS); operated ≤16 hrs; in ambient of -29°F to 104°F.

\*Up to \$25/unit; labor allowances of up to \$500/unit available for purchase – contact MaxLite representative for details.

DIMENSIONS			
PRODUCT	A	B	C
BLHE2-090DUF-XX	23.8"	12.6"	3.6"
BLHE2-135DUF-XX			
BLHE2-178DUF-XX			
BLHE2-090DUF-XXMS	29.3"	12.6"	3.6"
BLHE2-135DUF-XXMS			
BLHE2-178DUF-XXMS			
BLHE2-223DUF-XX	23.8"	17.3"	3.9"
BLHE2-223DUF-XXMS			

**MaxLite Makes It!**  
Don't see what you need? Additional wattages and specifications available upon request - contact your MaxLite rep!



MODEL SELECTION (Full list of order codes on pg. 2)		Typical order example: BLHE2-090DUF-40						
BLHE2	-	D	U	F				
FAMILY	-	WATTAGE (NOMINAL)	DIMMING	VOLTAGE	LENS	CCT	OPTIONS	CORDS & PLUGS
BLHE2= ECO Linear High Bay Gen 2	-	090= 90W	D= Dimming	U= 120-277V	F= Frosted	40= 4000K	(OMIT)= None	-C= Cord
		135= 135W				50= 5000K		
		178= 178W					MS= Bi-level Motion sensor with Remote Control Capability	-C1= 10-FT 3-Wire Cord W 5-15P (120V, 15A)
		223= 223W		H= 347-480V			<sup>1</sup> EM= Battery Backup Unit	-C2= 10-FT 3-Wire Cord W L7-15P (277V, 15A)
							<sup>2</sup> MSV= Bi-level Motion Sensor with Remote Control Capability	C3= 10-FT 3-Wire Cord L24-20P (347V, 20A)
								C4= 10-FT 3-Wire Cord L8-20P (480V, 20A)

<sup>1</sup> EM only available in Universal models

<sup>2</sup> MSV only used for high voltage

**SPECIFICATIONS:**

		BLHE2-090DUF-50	BLHE2-135DUF-50	BLHE2-178DUF-50	BLHE2-223DUF-50
ITEM	SPECIFICATION	DETAILS			
GENERAL PERFORMANCE	Power Consumption (W)	90 W	135 W	178 W	223W
	Lumens Delivered (lm)	11,264 lm	17,024 lm	22,077 lm	27,763 lm
	Efficacy (lm/W)	129 lm/W	129 lm/W	127 lm/W	128 lm/W
	CRI	≥80			
	Color Temperature (K)	4000K and 5000K			
	L70 Lumen Maintenance* (hours)	>100,000 hrs.			
	Color Consistency	Proprietary binning for uniform color			
ELECTRICAL	Power Factor	≥0.9			
	Input Voltage	120-277V or 347-480V			
	Dimming	Dimmable (0-10V)			
PHYSICAL	Mounting	V hook and 40" chain standard (see Mounting Accessories chart for other options)			
	Operating Temperature	-4°F to 122°F			
	Humidity	20-85% RH, non-condensing			
CERTIFICATION	Certification	FCC, cULus			
	Material Usage	RoHS compliant; no mercury			
	Environment	Indoor / Damp			
	Warranty	10 year warranty*			
QUALIFICATION	DesignLight Consortium	DLC Premium			



\*L70 Lumen maintenance calculated for LED chip at max Ambient of 122°F (50°C)

**ORDERING:**









ORDER CODE	MODEL NUMBER	DLC PRODUCT ID	WATTAGE	CCT
102407	BLHE2-090DUF-40	PH9LRJAH	90	4000K
14099925	BLHE2-090DUF-40MS*	PH9LRJAH		
102529	BLHE2-090DUF-50	PCQASBXS		5000K
14099926	BLHE2-090DUF-50MS*	PCQASBXS		
102599	BLHE2-135DUF-40	P0HAYA34	135	4000K
14099927	BLHE2-135DUF-40MS*	P0HAYA34		
102542	BLHE2-135DUF-50	PF1RNTSX		5000K
14099928	BLHE2-135DUF-50MS*	PF1RNTSX		
102612	BLHE2-178DUF-40	PB3BEUE9	178	4000K
14099929	BLHE2-178DUF-40MS*	PB3BEUE9		
102544	BLHE2-178DUF-50	PPXOH1Y0		5000K
14099930	BLHE2-178DUF-50MS*	PPXOH1Y0		
14099935	BLHE2-223DUF-40	PH5CDVQU	223	4000K
14099936	BLHE2-223DUF-40MS*	PH5CDVQU		
14099937	BLHE2-223DUF-50	PBYDF5MV		5000K
14099938	BLHE2-223DUF-50MS*	PBYDF5MV		

\*MS remote sold separately.

**SENSOR INFORMATION:**

SENSOR	TECHNOLOGY	DIMMING	DAYLIGHT HARVESTING	REMOTE CONTROL	
MS	HIGH FREQUENCY	BI-LEVEL	SET POINT	YES	
BLHE-MSOKIT	PIR	ON/OFF	SET POINT	NO	
MSV (347-480)	PIR	BI-LEVEL	SET POINT	YES	

\*For motion sensor setting and information, please visit [www.maxlite.com/controls](http://www.maxlite.com/controls)

ACCESSORIES				
DESCRIPTION	APPLICATION	MODEL NUMBER	ORDER CODE	ACCESSORY IMAGE
WIREGUARD	90W, 135W, 178W	BLHE2-WGW1	102661	
	223W	BLHE2-WGW2	102662	
SURFACE MOUNT KIT	90W, 135W, 178W	BLHE2-SMK1	102659	
	223W	BLHE2-SMK2	102660	
STEM MOUNT KIT (3/4" DIAMETER HOLE)	All Wattages	BLHE2-MPK	102658	
FIELD INSTALLABLE ON/OFF PIR MOTION SENSOR KIT	All Wattages	BLHE-MSOKIT	1409828	
15' CABLE KIT	All Wattages	MLCHKLSU15	74138	
20' CABLE KIT	All Wattages	MLCHKSQ	71119	
FIELD INSTALLABLE BATTERY BACKUP - PROVIDES 1300 LUMENS FOR 90 MINUTES	All Wattages	EBUUP5017D01108	100750	
REMOTE CONTROL FOR SENSOR COMMISSIONING	All Wattages <b>(120-277V)</b>	RMHYTHRC-05	108133	
REMOTE CONTROL FOR MSV 347-480V COMMISSIONING	All Wattages <b>(347-480V)</b>	FSIR-100	102184	

\* No mounting hardware is included. Battery backup must be remote installed.

**SENSOR SPECIFICATION:**

These fixtures use a high frequency sensor designed specifically for high bays. The sensors are able to "see through" sheetrock walls (and all other non-metal, non-concrete surfaces). If your application requires PIR technology, please contact MaxLite for field installable PIR kits. Remote control required for commissioning of sensor.



Model SAM6

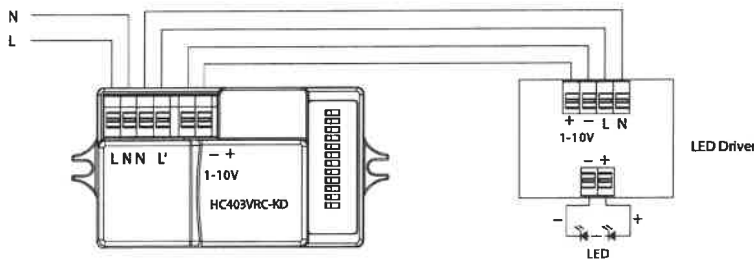
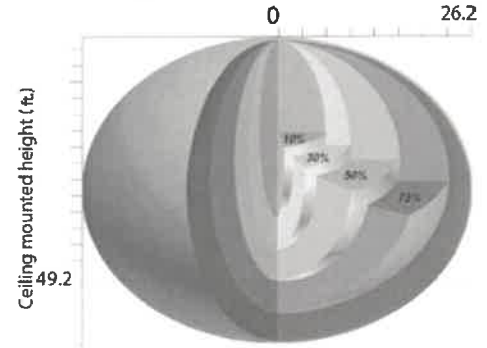

HRC-05  
Note: the buzzer beeps one time when RC receives signal successfully.

Below are all available settings for the MS (motion sensor) option. Default settings are highlighted in green.

**1 Detection Range**

Sensor sensitivity can be adjusted by selecting the combination on the DIP switches to fit precisely for each specific application.

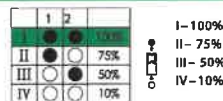

**2 Hold-time**

Select the dip switch configuration for the full brightness on-time after presense detection. Please note that this function is disabled when the natural daylight exceeds the daylight threshold setting for more than 5 minutes.

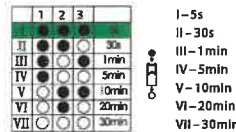

**3 Daylight Threshold**

Set the level according to the fixture and environment. The light will not turn on if ambient lux level exceeds the daylight threshold preset. Please note that the ambient lux level refers to Internal light reaching the sensor.

Disabling the daylight sensor will put the sensor into occupancy detection only mode.

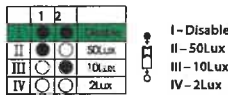

**4 Stand-by period (corridor function)**

This is the time period you would like to keep at the low light output level before it is completely switched off in the long absence of people.

Note: "0s" means on/off control;

"∞" means the stand-by time is infinite and the fixture never switches off.

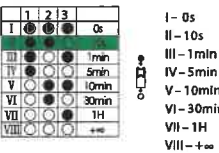

**5 Stand-by dimming level**

The setting is used to select the desired dimmed light level used in periods of absence for enhanced comfort and safety.



<b>Sensor principle</b>	High Frequency (microwave)
<b>Operation frequency</b>	5.8GHz +/- 75MHz
<b>Transmission power</b>	<0.2mW
<b>SAM5 SAM9</b>	Max. 8m x 5m
<b>SAM6</b>	Max. 16m x 15m
<b>Detection angle</b>	30° ~ 150°
<b>DIP Switch Settings (HC403VRC-KD):</b>	
<b>Sensitivity</b>	10% / 50% / 75% / 100%
<b>Hold-time</b>	5s ~ 30min (selectable)
<b>Daylight threshold</b>	2 ~ 50 lux, disabled
<b>Stand-by period</b>	0s ~ 1h, +∞ (selectable)
<b>Stand-by dimming level</b>	10% / 20% / 30% / 50%
<b>Operation temperature</b>	Ta: -20°C ~ +60°C
<b>Case temperature (Max.)</b>	Tc: +80°C
<b>IP rating</b>	IP20



**LED ENCLOSED RATED  
OMNIDIRECTIONAL A-LAMP**  
A19 GEN 8 SERIES



6W, 9W & 11W



15W



**PRODUCT DESCRIPTION:**

MaxLite's LED enclosed rated Omnidirectional A-Line lamp replicate true A19 incandescents. They are suited to a wide variety of residential and commercial applications, including pendants, wall sconces, table and floor lamps.

**FEATURES:**

- 6W, 480lm, 40W Inc. replacement
- 9W, 800lm, 60W Inc. replacement
- 11W, 1100lm, 75W Inc. replacement
- 15W, 1600lm, 100W Inc. replacement
- Dimmable down to 10%
- Power factor: ≥ 0.70
- 25,000 hour life (L70 standards)
- CRI: ≥ 80
- Volts: 120V
- Available in E26
- Suitable for dry and damp locations
- Suitable for use in fully enclosed luminaires
- Energy Star Certified

**APPLICATIONS**

- Pendants
- Table and floor lamps
- Sconces

**WARRANTY:**

5-year standard warranty  
(further details available at [www.maxlite.com/warranties](http://www.maxlite.com/warranties))  
Product may be eligible for a warranty extension to 10 years, for an additional fee. Contact MaxLite for details.

**DIMENSION CHART:**

WATTAGE	WIDTH	LENGTH
6W	2.36	4.13
9W	2.36	4.13
11W	2.36	4.55
15W	2.36	4.65

**ORDERING:**

MODEL SELECTION (Full list of order codes on pg. 2)		Typical order example: E9A19DLED27/G8		
FAMILY	BASE	DIMMABILITY	CCT	/G8
E6A19 = 6 watts, A19 E9A19 = 9 watts, A19 E11A19 = 11 watts, A19 E15A19 = 15 watts, A19	(OMIT) = E26	DLED = Dimmable	27 = 2700K 30 = 3000K 40 = 4000K 50 = 5000K*	/G8 = Generation 8

**SPECIFICATIONS:**

ITEM	SPECIFICATION	DETAILS			
		E6A19DLEDxx/G8	E9A19DLEDxx/G8	E11A19DLEDxx/G8	E15A19DLEDxx/G8
GENERAL PERFORMANCE	Power Consumption	6W	9W	11W	15W
	Lumens Delivered	480	800	1100	1600
	Efficacy (lm/w)	80	89	100	106
	CRI	≥80			
	Color Temperature (CCT)	2700K, 3000K, 4000K, 5000K			
	Lumen Maintenance (L70)	25,000 Hours			
ELECTRICAL	Power Factor	≥0.70			
	Input Voltage	120V			
PHYSICAL	Base Type	E26			
	Operating Temperature	-4°F - 104°F			
CERTIFICATION	Certification	ENERGY STAR, UL Listed, FCC, RoHS Compliant			
	Environment	Dry, Damp			
	Warranty	5 year standard warranty			

Lighting layouts and spacing criteria available upon request

**ORDERING:**

ORDER CODE	MODEL	ENERGY STAR	WATTS	EQUIVALENCY	DELIVER LUMENS	EFFICACY (lm/W)	CRI	CCT	DIMENSIONS (W" x MOL")
<b>E26 Base</b>									
14099390	E6A19DLED27/G8	★	6	40W Inc.	480	80	80	2700K	2.36" x 4.25"
14099392	E6A19DLED30/G8	★	6	40W Inc.	480	80	80	3000K	
14099393	E6A19DLED40/G8	★	6	40W Inc.	480	80	80	4000K	
14099394	E9A19DLED27/G8	★	9	60W Inc.	800	88	80	2700K	
14099397	E9A19DLED30/G8	★	9	60W Inc.	800	88	80	3000K	
14099398	E9A19DLED40/G8	★	9	60W Inc.	800	88	80	4000K	
103000	E9A19DLED50/G8	★	9	60W Inc.	800	88	80	5000K	
14099399	E11A19DLED27/G8	★	11	75W Inc.	1100	100	80	2700K	
103218	E11A19DLED27/G8/4PC	★	11	75W Inc.	1100	100	80	2700K	
14099400	E11A19DLED30/G8	★	11	75W Inc.	1100	100	80	3000K	
14099401	E11A19DLED40/G8	★	11	75W Inc.	1100	100	80	4000K	2.36" x 4.61"
14099402	E15A19DLED27/G8	★	15	100W Inc.	1600	106	80	2700K	
14099403	E15A19DLED30/G8	★	15	100W Inc.	1600	106	80	3000K	
14099404	E15A19DLED40/G8	★	15	100W Inc.	1600	106	80	4000K	

★ ENERGY STAR Certified

Specifications are subject to change without notice.

**COMPATIBLE DIMMERS FOR E6A19DLEDXX/G8:**

BRAND	MODEL	COMPATIBLE	BRAND	MODEL	COMPATIBLE	BRAND	MODEL	COMPATIBLE
ADRONE	ADPD453LW2	NO	LUTRON	CTCL-153P-WH	NO	LUTRON	S-600PR-WH	NO
	ADTP703TUW4	YES		CTCL-153PDH-WH	YES		S-603PGH-WH	NO
	ADWR703HW4	YES		D-600PH-3CK	NO		S-603PH-WH	NO
AH	SDM/600	YES		D-600PH-DK	YES		SCL-153P-WH	NO
	SDM3/1000	NO		D-600R-IV	YES		SCL-153PH-WH	NO
CONFORTO COMODIDADE	DLE-01	NO		D-600R-WH	YES		SCL-153PH-WH	YES
COOPER	AAL06-C1	NO		D-600RH-DK	YES		TG-600PH-IV	YES
	DAL06P-C2-K	NO		DV-600P-WH	NO		TG-600PH-WH	NO
	SAL06P-W-K	NO		DV-600PH-WH	YES		TG-600PNLH-WH	NO
	TAL06P-C2-K	NO		DV-603P	NO		TG-603PGH-WH	NO
CTL	DM600-12-3	YES		DV-603PH-WH	YES	TGCL-153PH-WH	YES	
	AAL06-C1	NO		DV-603PH-WH	YES	TGCL-153PH-WH	NO	
EATON	SAL06P-LA-K	NO		DV-603PR	NO	TGCL-153PLH-WH	NO	
	TAL06P1-C5	NO		DVCL-153P-WH	YES	LUX	DM600-12	YES
	GE	18Q24		DVCL-153P-WH-3	YES	MAXXIMA	MEW-DM600	YES
HALO	SAL06P-W-HALOGF2	NO		DVCL-153PH	NO	RHINE	UC7067RYE	NO
LEGRAND	HCL453PTC	YES		DVCL-153PR-WH	YES	TAANCIL	Dim-L13B	NO
	RHCL453PW	YES		DVCL-253PH	YES			
LEVITON	6681	YES		DVELV-300P-WH	NO			
	6684	YES		DVELV-303P-WH	YES			
	603-6631-A	YES		DVW-600PH-WH	NO			
	6631-A	YES		DVWCL-153PH-WH	NO			
	6631-LA	YES		DVWCL-153PH-WHC	NO			
	6631-LA	NO		LECL-153PH-WH	YES			
	6683	NO		LGCL-153CL	NO			
	6683-10Z	YES		MACL-153M-WH	YES			
	6683-IW	NO		MACL-153MH-WH	YES			
	IPE04-1LZ 400VA	NO		MACL-153MLH-WH	YES			
	IPI06	NO		MACL-153MLRH-WH	YES			
	IPI06-1LZ	YES		MACL-153MR-WH	YES			
	IP110-1LZ	NO	MAELV-600-WH	YES				
	NO.6631	YES	MAW-600	NO				
	NO.6672	YES	MAW-600H-AL	NO				
	NO.6674	NO	MAW-600H-WH	NO				
	NO.6681	NO	MIR-600THW-WH	NO				
	NO.6681	NO	MRF2-6CL-WH	NO				
NO.IPL06	YES	MSCL-OP153MH-WH	YES					
S-600P-WH	NO	PD-6WCL-WH-P	NO					
LUS	DM600-15L	NO	S-10PH	YES				
LUTRON	AY-600PH-WH	NO	S-600	YES				
	AYCL-153P-WH	YES	S-600-AL	YES				
	AYCL-153PH	YES	S-600-IV	YES				
	CT-103P-WH	YES	S-600H-WH	YES				
	CT-600PR-WH	NO	S-600P-WH	NO				

Specifications are subject to change without notice.



**COMPATIBLE DIMMERS FOR E9A19DLEDXX/G8:**

BRAND	MODEL	COMPATIBLE	BRAND	MODEL	COMPATIBLE	BRAND	MODEL	COMPATIBLE
ADRONE	ADPD453LW2	YES	LUTRON	CTCL-153P-WH	NO	LUTRON	S-600PR-WH	NO
	ADTP703TJW4	NO		CTCL-153PDH-WH	YES		S-603PGH-WH	NO
	ADWR703HW4	YES		D-600PH-3CK	NO		S-603PH-WH	NO
AH	SDM/600	YES		D-600PH-DK	YES		SCL-153P-WH	NO
	SDM3/1000	NO		D-600R-IV	YES		SCL-153PH-WH	NO
CONFORTO COMODIDADE	DLE-01	NO		D-600R-WH	YES		SCL-153PH-WH	YES
COOPER	AAL06-C1	NO		D-600RH-DK	YES		TG-600PH-IV	YES
	DAL06P-C2-K	NO		DV-600P-WH	NO		TG-600PH-WH	NO
	SAL06P-W-K	NO		DV-600PH-WH	YES		TG-600PNLH-WH	NO
	TAL06P-C2-K	NO		DV-603P	NO		TG-603PGH-WH	NO
CTL	DM600-12-3	YES		DV-603PH-WH	YES	TGCL-153PH-WH	YES	
	AAL06-C1	NO		DV-603PH-WH	YES	TGCL-153PH-WH	NO	
EATON	SAL06P-LA-K	NO		DV-603PR	NO	TGCL-153PLH-WH	NO	
	TAI.06P1-C5	NO		DVCL-153P-WH	YES	LUX	DM600-12	YES
GE	18024	NO		DVCL-153P-WH-3	YES	MAXXIMA	MEW-DM600	YES
HALO	SAL06P-W-HALOGF2	NO		DVCL-153PH	NO	RHINE	UC7067RYE	NO
LEGRAND	HCL453PTC	YES		DVCL-153PR-WH	YES	TAANCIL	Dim-L13B	NO
	RHCL453PW	YES		DVCL-253PH	YES			
LEVITON	6681	YES		DVELV-300P-WH	NO			
	6684	YES		DVELV-303P-WH	YES			
	603-6631-A	YES		DVW-600PH-WH	NO			
	6631-A	YES		DVWCL-153PH-WH	NO			
	6631-LA	YES		DVWCL-153PH-WHC	NO			
	6631-LA	NO		LECL-153PH-WH	YES			
	6683	NO		LGCL-153CL	NO			
	6683-10Z	YES		MACL-153M-WH	YES			
	6683-1W	NO		MACL-153MH-WH	YES			
	IPE04-1LZ 400VA	NO		MACL-153MLH-WH	YES			
	IPI06	NO		MACL-153MLRH-WH	YES			
	IPI06-1LZ	YES		MACL-153MR-WH	YES			
	IPI10-1LZ	NO	MAELV-600-WH	YES				
	NO.6631	YES	MAW-600	NO				
	NO.6672	YES	MAW-600H-AL	NO				
	NO.6674	NO	MAW-600H-WH	NO				
	NO.6681	NO	MIR-600THW-WH	NO				
NO.6681	NO	MRF2-6CL-WH	NO					
NO.IPL06	YES	MSCL-OP153MH-WH	YES					
S-600P-WH	NO	PD-6WCL-WH-P	NO					
LUS	DM600-15L	NO	S-10PH	YES				
LUTRON	AY-600PH-WH	NO	S-600	YES				
	AYCL-153P-WH	YES	S-600-AL	YES				
	AYCL-153PH	YES	S-600-IV	YES				
	CT-103P-WH	YES	S-600H-WH	YES				
	CT-600PR-WH	NO	S-600P-WH	NO				

Specifications are subject to change without notice.

**COMPATIBLE DIMMERS FOR E11A19DLEDXX/G8:**

BRAND	MODEL	COMPATIBLE	BRAND	MODEL	COMPATIBLE	BRAND	MODEL	COMPATIBLE
ADRONE	ADPD453LW2	NO	LUTRON	CTCL-153P-WH	NO	LUTRON	S-600PR-WH	NO
	ADTP703TUW4	NO		CTCL-153PDH-WH	YES		S-603PGH-WH	NO
	ADWR703HW4	NO		D-600PH-3CK	NO		S-603PH-WH	NO
AH	SDM/600	NO		D-600PH-DK	YES		SCL-153P-WH	YES
	SDM3/1000	NO		D-600R-IV	NO		SCL-153PH-WH	NO
CONFORTO COMODIDADE	DLE-01	YES		D-600R-WH	NO		SCL-153PH-WH	YES
COOPER	AAL06-C1	NO		D-600RH-DK	YES		TG-600PH-IV	NO
	DAL06P-C2-K	NO		DV-600P-WH	YES		TG-600PH-WH	YES
	SAL06P-W-K	NO		DV-600PH-WH	YES		TG-600PNLH-WH	NO
	TAL06P-C2-K	NO		DV-603P	YES		TG-603PGH-WH	NO
CTL	DM600-12-3	YES		DV-603PH-WH	YES	TGCL-153PH-WH	NO	
				DV-603PH-WH	NO	TGCL-153PH-WH	YES	
EATON	AAL06-C1	NO		DV-603PR	NO	TGCL-153PLH-WH	NO	
	SAL06P-LA-K	NO		DVCL-153P-WH	YES	LUX	DM600-12	NO
	TAL06P1-C5	NO		DVCL-153P-WH-3	YES	MAXXIMA	MEW-DM600	YES
GE	18024	NO		DVCL-153PH	YES	OLEGRAND	UC7067RYE	YES
HALO	SAL06P-W-HALOGF2	NO		DVCL-153PH-WH	YES	RHINE	Dim-L13B	YES
LEGRAND	HCL453PTC	YES		DVCL-253PH	YES	TAANCIL	Dim-L13B	YES
	RHCL453PW	YES		DVELV-300P-WH	NO			
LEVITON	6681	NO		DVELV-303P-WH	YES			
	6684	NO		DVW-600PH-WH	NO			
	603-6631-A	NO		DVWCL-153PH-WH	YES			
	6631-A	NO		DVWCL-153PH-WHC	YES			
	6631-LA	YES		LECL-153PH-WH	YES			
	6631-LA	NO		LGCL-153CL	NO			
	6683	NO		MACL-153M-WH	YES			
	6683-10Z	NO		MACL-153MH-WH	YES			
	6683-IW	NO		MACL-153MLH-WH	YES			
	IPE04-1LZ 400VA	NO		MACL-153MLRHW-WH	YES			
	IPI06	YES		MACL-153MR-WH	YES			
	IPI06-1LZ	YES	MAELV-600-WH	YES				
	IPI10-1LZ	NO	MAW-600	NO				
	NO.6631	YES	MAW-600H-AL	YES				
	NO.6672	YES	MAW-600H-WH	NO				
	NO.6674	YES	MIR-600THW-WH	NO				
	NO.6681	NO	MRF2-6CL-WH	NO				
	NO.6681	YES	MSCL-OP153MH-WH	YES				
	NO.IPL06	YES	PD-6WCL-WH-P	NO				
	LUS	S-600P-WH	NO	S-10PH	YES			
LUTRON	DM600-15L	NO	S-600	YES				
	AY-600PH-WH	YES	S-600-AL	NO				
	AYCL-153P-WH	YES	S-600-IV	YES				
	AYCL-153PH	YES	S-600H-WH	YES				
	CT-103P-WH	YES	S-600P-WH	NO				
	CT-600PR-WH	YES						

Specifications are subject to change without notice.

**COMPATIBLE DIMMERS FOR E15A19DLEDXX/G8:**

BRAND	MODEL	COMPATIBLE	BRAND	MODEL	COMPATIBLE	BRAND	MODEL	COMPATIBLE
ADRONE	ADPD453LW2	NO	LUTRON	CTCL-153P-WH	NO	LUTRON	S-600PR-WH	NO
	ADTP703TUW4	NO		CTCL-153PDH-WH	YES		S-603PGH-WH	NO
	ADWR703HW4	NO		D-600PH-3CK	NO		S-603PH-WH	NO
AH	SDM/600	NO		D-600PH-DK	YES		SCL-153P-WH	YES
	SDM3/1000	NO		D-600R-IV	NO		SCL-153PH-WH	NO
CONFORTO COMODIDADE	DLE-01	YES		D-600R-WH	NO		SCL-153PH-WH	YES
COOPER	AAL06-C1	NO		D-600RH-DK	YES		TG-600PH-IV	NO
	DAL06P-C2-K	NO		DV-600P-WH	YES		TG-600PH-WH	YES
	SAL06P-W-K	NO		DV-600PH-WH	YES		TG-600PNLH-WH	NO
	TAL06P-C2-K	NO		DV-603P	YES		TG-603PGH-WH	NO
CTL	DM600-12-3	YES		DV-603PH-WH	YES	TGCL-153PH-WH	NO	
	AAL06-C1	NO		DV-603PH-WH	NO	TGCL-153PH-WH	YES	
EATON	SAL06P-LA-K	NO		DV-603PR	NO	TGCL-153PLH-WH	NO	
	TAL06P1-C5	NO		DVCL-153P-WH	YES	LUX	DM600-12	NO
	GE	18024		DVCL-153P-WH-3	YES	MAXXIMA	MEW-DM600	YES
HALO	SAL06P-W-HALOGF2	NO		DVCL-153PH	YES	RHINE	UC7067RYE	YES
LEGRAND	HCL453PTC	YES		DVCL-153PR-WH	YES	TAANCIL	Dim-L13B	YES
	RHCL453PW	YES		DVCL-253PH	YES			
LEVITON	6681	NO		DVELV-300P-WH	NO			
	6684	NO		DVELV-303P-WH	YES			
	603-6631-A	NO		DVW-600PH-WH	NO			
	6631-A	NO		DVWCL-153PH-WH	YES			
	6631-LA	YES		DVWCL-153PH-WHC	YES			
	6631-LA	NO		LECL-153PH-WH	YES			
	6683	NO		LGCL-153CL	NO			
	6683-10Z	NO		MACL-153M-WH	YES			
	6683-1W	NO		MACL-153MH-WH	YES			
	IPE04-1LZ 400VA	NO		MACL-153MLH-WH	YES			
	IPI06	YES		MACL-153MLRH-WH	YES			
	IPI06-1LZ	YES		MACL-153MR-WH	YES			
	IPI10-1LZ	NO	MAELV-600-WH	YES				
	NO.6631	YES	MAW-600	NO				
	NO.6672	YES	MAW-600H-AL	YES				
	NO.6674	YES	MAW-600H-WH	NO				
	NO.6681	NO	MIR-600THW-WH	NO				
	NO.6681	YES	MRF2-6CL-WH	NO				
NO.IPL06	YES	MSCL-OP153MH-WH	YES					
S-600P-WH	NO	PD-6WCL-WH-P	NO					
LUS	DM600-15L	NO	S-10PH	YES				
LUTRON	AY-600PH-WH	YES	S-600	YES				
	AYCL-153P-WH	YES	S-600-AL	NO				
	AYCL-153PH	YES	S-600-IV	YES				
	CT-103P-WH	YES	S-600H-WH	YES				
	CT-600PR-WH	YES	S-600P-WH	NO				

Specifications are subject to change without notice.



## LED T8 - LINEAR REPLACEMENT LAMP

Single-Ended/ Double-Ended Power  
 Coated Glass Series  
 UL TYPE-B



### FEATURES:

- **Wattage:**
  - 9W, 2FT, ≥1125 lumens, replaces 17W fluorescent T8
  - 12W, 3FT, ≥1,225 lumens, replaces 25W fluorescent T8
  - 11.5W, 4FT, ≥1,650 lumens, replaces 32W fluorescent T8
- **Universal Voltage:** 120V-277V applications
- **Color Rendering Index (CRI):** ≥80
- **Beam angle:** 330°
- **THD** <20%
- **Power factor:** ≥ 0.90
- Easy retrofit into most common linear fluorescent fixtures
- Simple ballast bypass, single-ended/ double-ended power
- **Compatible with shunted and non-shunted lamp holders**
- Instant on
- Mercury free and virtually no UV or IR light
- Non dimmable
- Suitable for enclosed fixture
- Suitable for dry and damp locations
- ETL Sanitation listed (tested under NSF standard)
- All glass construction with PET coating
- **Rated Lifetime @ L70:** 62,000 Hours
- Products L9T8DE235-CG4, L9T8DE240-CG4, L9T8DE250-CG4, L11.5T8DE435-CG4, L11.5T8DE440-CG4 & L11.5T8DE450-CG4 are listed on the DLC QPL

### PRODUCT DESCRIPTION:

Offering the versatility of single or double ended wiring options in one product SKU, this LED UL Type-B T8 lamp is an easy retrofit into most common linear fluorescent fixtures with shunted or non-shunted lamp holders (see re-lamping examples provided). In addition to flexible installation features that save installers time and money, the Single-Ended/Double-Ended LED T8 lamp consumes up to 50% less energy than standard fluorescent tubes, providing facilities with long-term operational savings.

### WARRANTY:

5-year standard warranty  
 (further details available at [www.maxlite.com/warranties](http://www.maxlite.com/warranties))  
 Product may be eligible for a warranty extension to 10 years, for an additional fee. Contact MaxLite for details.

MODEL SELECTION (Full list of order codes on pg. 2)			Typical order example: L9T8DE240-CG4		
L	9	T8	DE	2	
FAMILY	WATTAGE	LAMP TYPE	OPERATION	LENGTH	COLOR TEMPERATURE
L= LED Linear	9= 9W	T8= T8 tube	DE= Double-Ended Power	2= 2FT	<b>35-CG4=</b> 3500K, Coated Glass <b>40-CG4=</b> 4000K, Coated Glass <b>50-CG4=</b> 5000K, Coated Glass
L	12	T8	DE	3	
FAMILY	WATTAGE	LAMP TYPE	OPERATION	LENGTH	COLOR TEMPERATURE
L= LED Linear	12= 12W	T8= T8 tube	DE= Double-Ended Power	3= 3FT	<b>35-CG4=</b> 3500K, Coated Glass <b>40-CG4=</b> 4000K, Coated Glass <b>50-CG4=</b> 5000K, Coated Glass
L	11.5	T8	DE	4	
FAMILY	WATTAGE	LAMP TYPE	OPERATION	LENGTH	COLOR TEMPERATURE
L= LED Linear	11.5= 11.5W	T8= T8 tube	DE= Double-Ended Power	4= 4FT	<b>35-CG4=</b> 3500K, Coated Glass <b>40-CG4=</b> 4000K, Coated Glass <b>50-CG4=</b> 5000K, Coated Glass

Specifications are subject to change without notice.



# LED T8 - LINEAR REPLACEMENT LAMP

Single-Ended/ Double-Ended Power Coated Glass Series  
UL TYPE-B

## SPECIFICATIONS:

ITEM	SPECIFICATION	L9T8DE2xx-CG4	L12T8DE3xx-CG4	L11.5T8DE4xx-CG4
		2FT - DETAILS	3FT - DETAILS	4FT - DETAILS
GENERAL PERFORMANCE	Power Consumption (W)	9W	12W	11.5W
	Lumens Delivered (lm)	1125-1188	1225-1300	1650-1800
	Efficacy	≥125 lm/w	≥102 lm/w	≥143 lm/w
	CRI	≥80		
	Beam Angle	330°		
	Color Temperature (CCT)	3500K, 4000K, 5000K		
	Lumen Maintenance (L70)	62,000 Hours		
ELECTRICAL	Power Factor	≥ 0.90		
	Input Voltage	120V-277V, 50/60 Hz		
PHYSICAL	Operating Temperature	-4°F to 113°F		
	Lens	Opal (Frosted) - Coated Glass		
CERTIFICATION	Certification	CULus Classified, ETL Sanitation	cULus Classified, ETL Sanitation	CULus Classified, ETL Sanitation
	Material Usage	RoHS compliant; no mercury		
	Environment	Dry & Damp, Enclosed Fixtures		
	Warranty	5-year standard warranty		
QUALIFICATION	DesignLight Consortium	DLC 4.2 Standard	N/A	DLC 4.2 Standard

Lighting layouts and spacing criteria available upon request

## ORDERING:

ORDER CODE	MODELS	WATTS	LUMENS (lm)	EFFICACY (lm/W)	CCT	CASE QTY
<b>9W 2FT T8 MODELS</b>						
1409555	L9T8DE235-CG4	9W	1125	125 lm/W	3500K	25 pcs
1409556	L9T8DE240-CG4		1200	133 lm/W	4000K	
1409557	L9T8DE250-CG4		1250	139 lm/W	5000K	
<b>12W 3FT T8 MODELS</b>						
1409555	L12T8DE335-CG4	12W	1225	102 lm/W	3500K	25 pcs
1409556	L12T8DE340-CG4		1250	104 lm/W	4000K	
1409557	L12T8DE350-CG4		1300	108 lm/W	5000K	
<b>11.5W 4FT T8 MODELS</b>						
1409558	L11.5T8DE435-CG4	11.5W	1650	143 lm/W	3500K	25 pcs
1409559	L11.5T8DE440-CG4		1750	152 lm/W	4000K	
1409560	L11.5T8DE450-CG4		1800	156 lm/W	5000K	

Specifications are subject to change without notice.

Phone: 1-800-555-5629 | Fax: 973-244-7333 | Web: www.maxlite.com | E-mail: info@maxlite.com

MAX17095  
Revised: 01-24-20





**RELAMPING EXAMPLES:**

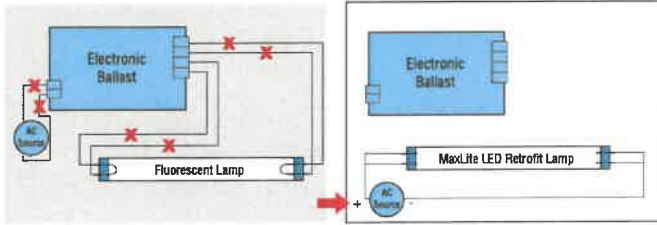

**Figure 1. - Double-Ended connection**

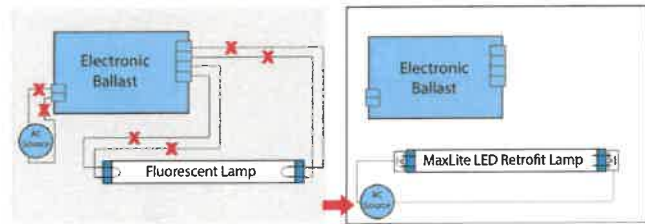

**Figure 2. - Retrofit with One Lamp**

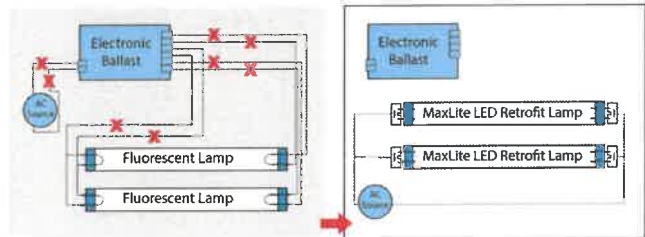

**Figure 3. - Retrofit with Two Lamps**

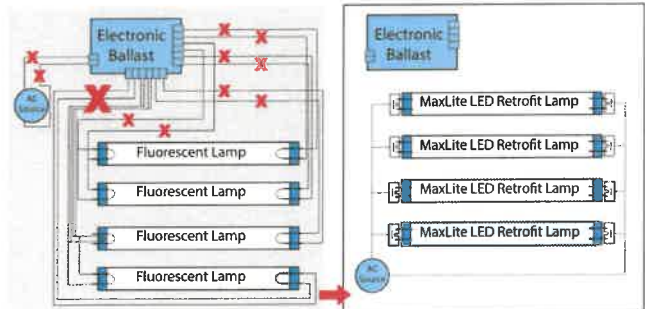

**Figure 4. - Retrofit with Three/Four Lamps**

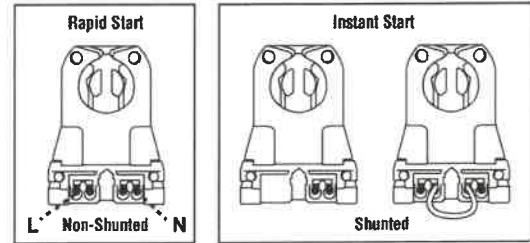

**Figure 1. - Non-shunted & Shunted Lamp Holder**



**Figure 2. - Single sided connection**

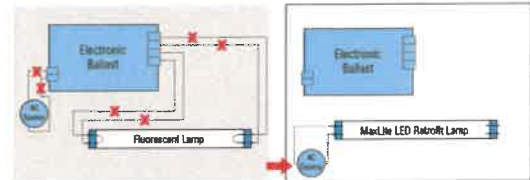

**Figure 3. - Retrofit with One Lamp**

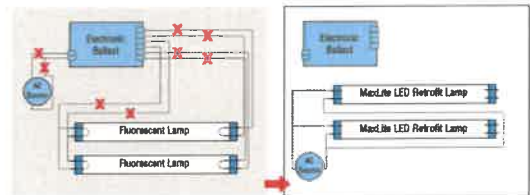

**Figure 4. - Retrofit with Two Lamps**

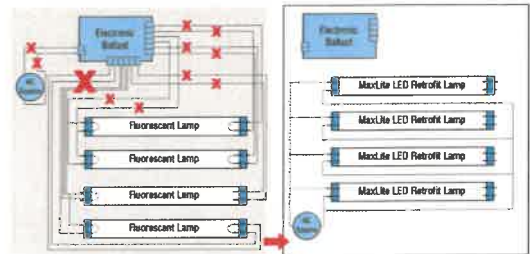

**Figure 5. - Retrofit with Three/Four Lamps**

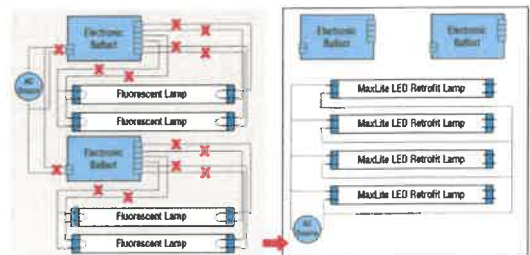

**Figure 6. - Retrofit with Three/Four Lamps & Two Ballasts**

# EMERGENCY EXIT SERIES

The EX and EXC Exit Sign series offer quality emergency lighting solutions for stairway, hallway and other commercial office applications. The low profile makes it ideal to mount on walls or ceilings indicating the path of egress for up to 90 minutes after a power loss.

**FEATURES:**

- Long lasting LEDs - over 10 years
- High impact UV stabilized flame rated thermoplastic housing (UL94 V-0)
- 120V or 277V AC input
- Nickel Cadmium (NiCad) battery meets UL 90 minute emergency lighting requirement
- Test switch and AC-On indicator included
- Wall or ceiling mount capabilities
- Single or double face with removable chevrons
- Combo heads adjustable
- Remote Head = 85 lumens per head
- Remote Capable (RC) works with up to 2 remote heads
- Canopy included
- Temperature ratings are 20°-30°C

**CERTIFICATIONS:**

- UL924 Listed for Damp Locations (DL)
- CEC T20 Compliant
- NFPA 101 and NFPA 70
- OSHA

**WARRANTY:**

5-year standard warranty\* (further details available at [www.maxlite.com/warranties](http://www.maxlite.com/warranties))

\*Product may be eligible for a warranty extension to 10 years, for an additional fee. Contact MaxLite for details.



EX-RW



EX-GW

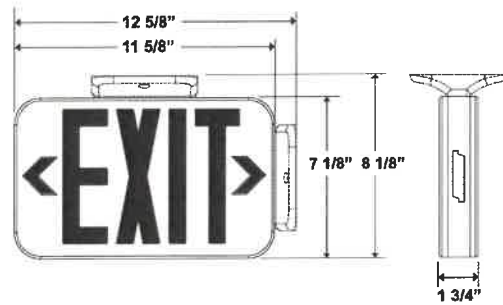

EXC-RW



EXC-GW

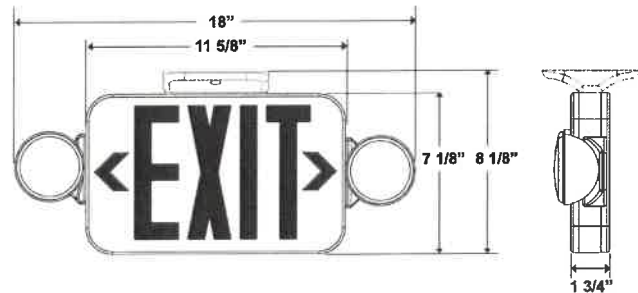

## EMERGENCY EXIT SERIES

### ORDERING INFORMATION:

PRODUCT IMAGE	ORDER NUMBER	MODEL	DESCRIPTION	FINISH	PERFORMANCE
	14101486	EX-RW	Exit, Thermoplastic, Red Letters, NiCad Battery, White	White	1.78W (120V) 1.88W (277V)
	103369	EX-RWRC	Exit, Thermoplastic, Red Letters, White, Remote Head Capable	White	1.78W (120V) 1.88W (277V)
	14101487	EX-GW	Exit, Thermoplastic, Green Letters, NiCad Battery, White	White	1.49W (120V) 1.57 (277V)
	103368	EX-GWRC	Exit, Thermoplastic, Green Letters, White, Remote Head Capable	White	1.49W (120V) 1.57 (277V)
	14101488	EXC-RW	Exit & Emergency Combo, Thermoplastic, Red Letters, NiCad Battery, White	White	4.2W (120V) 3.2W (277V)
	103370	EXC-RWRC	Exit & Emergency Combo, Thermoplastic, Red Letters, White, remote Head Capable	White	4.2W (120V) 3.2W (277V)
	14101489	EXC-GW	Exit & Emergency Combo, Thermoplastic, Green Letters, NiCad Battery, White	White	3.22W (120V) 3.18W (277V)
	103371	EXC-GWRC	Exit & Emergency Combo, Thermoplastic, Green Letters, White, remote Head Capable	White	3.22W (120V) 3.18W (277V)

**HID POST TOP**  
HID SERIES



**PRODUCT DESCRIPTION:**

MaxLite's HID Post Top lamps are an easy and long-lasting replacement for HID bulbs in high/low bay fixtures and decorative post top luminaires. Designed to retrofit E26/E39/EX39 sockets with a simple ballast bypass, these LED lamps deliver high quality illumination at 60 percent energy savings vs. conventional light sources.



**FEATURES:**

- Mounting: Vertical, base up or base down
- Simple ballast bypass
- Instant-on, no warm up time
- Mercury free and virtually no UV or IR light
- Built-in intelligent over temperature protection IC
- Surge protection: 4kV
- THD: <20%
- Base: EX39 Mogul, E26

**WARRANTY:**

5-year standard warranty  
(further details available at [www.maxlite.com/warranties](http://www.maxlite.com/warranties))  
Product may be eligible for a warranty extension to 10 years, for an additional fee. Contact MaxLite for details.

**ORDER STRUCTURE**

WATTAGE (NOMINAL)	FAMILY	COLOR TEMPERATURE	BASE
27= 27W	PT = HID Post Top	40= 4000K	E26
36= 36W		50= 5000K	EX39
45= 45W			
54= 54W			
100= 100W			

**NOTES:**

1. E26 Base available for 27W only.
2. No DLC on 27W Model.
3. 27W not compatible with any sensors.



**STOCKED ITEMS**

ORDER CODE	MODEL NUMBER	DLC #	QTY IN MASTER CARTON
14102035	27PT40E26	N/A	16
14102034	27PT50E26	N/A	
14102037	36PT40EX39	PL8EWGDGDC3T	
14102036	36PT50EX39	PL7ORAME3GO2	
14102039	45PT40EX39	PL904U65M1HC	
14102038	45PT50EX39	PLLBW4UEULMW	
14102041	54PT40EX39	PLK64DDO7BY9	
14102040	54PT50EX39	PLAV04QGJ6WJ	6
14102043	100PT40EX39	PL5J74LJZ7J6	
14102042	100PT50EX39	PL3GVYB80MS5	

**SPECIFICATIONS**

		27PTxxE26	36PTxxEX39	45PTxxEX39	54PTxxEX39	100PTxxEX39
ITEM	SPECIFICATION	DETAILS				
GENERAL PERFORMANCE	Input Power (W)	27W	36W	45W	54W	100W
	Replacement	100W MH	150W MH	175W MH	200-250W MH	400W MH
	Lumens Delivered (lm)	3,900 lm	5,400 lm	6,750 lm	8,100 lm	15,000 lm
	Efficacy (lm/W)	144 lm/W	150 lm/W			
	CRI	>80				
	Color Temperature (K)	4000K and 5000K				
	L70 Lumen Maintenance* (hours)	50,000 Hrs.				
ELECTRICAL	Power Factor	≥0.9				
	Input Voltage	120-277V				
PHYSICAL	Rated to Enclosed Fixture	Yes				
	Operating Temperature	-40°F - 140°F				
	Base Type	EX26	EX39			
QUALIFICATION	Certifications	FCC, cULus Listed , cULus Classified, RoHS Compliant, LM80				
	Design Lights Consortium	N/A	DLC Listed 4.4*			
	Material Usage	no mercury				
	Environment	Damp				
	Warranty	5 year standard warranty				

**NOTE:**

\* 27W is not DLC Listed.

**DIMENSIONS**

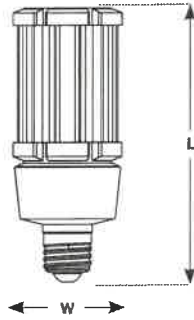

DIMENSIONS		
PRODUCT	L	W
27PT40E26	6.6'	2.4'
27PT50E26		
36PT40EX39	8.3'	3.3'
36PT50EX39		
45PT40EX39	9.5'	3.3'
45PT50EX39		
54PT40EX39		
54PT50EX39		
100PT40EX39	10.2'	5.1'
100PT50EX39		

**ACCESSORIES**

DESCRIPTION	MODEL NUMBER	ORDER CODE	ACCESSORY IMAGE
TEMP LIGHT WIRE FIXTURE WITH MOGUL BASE	SKFTLE39	71045	
PHOTOCELL SENSOR	DTDS-PT <sup>1</sup>	103637	
MICROWAVE SENSOR	MS-PT <sup>1</sup>	103638	
PIR SENSOR	PIR-PT <sup>1</sup>	103636	

**NOTES:**

1. 27W not compatible with any sensors.

**LED BR LAMPS G3**  
BR20, BR30, BR40 SERIES



7W BR20

8W BR30  
11W BR30



12W BR40  
17W BR40



**PRODUCT DESCRIPTION:**

With a full array of BR lamps, MaxLite products offer an immediate payback with LED replacements for 50-, 65-, 75-, and 100-watt incandescent lamps. Available in a standard medium base, the LED BR lamp is an ideal lighting solution for track lights, display lights and recessed lights. They provide efficient, general lighting suited for architectural, residential, retail, office space and hospitality applications.

**FEATURES:**

- 120V, 60Hz
- 25,000 hour life (at L70 standards)
- CRI: >80
- ENERGY STAR Certified
- BR lens conceals LEDs from sight and evenly distributes the light
- Smooth aluminum housing with ANSI standard form factor
- Dimmable down to ten percent
- Operating temperature: -4°F to 104°F
- Suitable for use in damp locations
- Not for use in enclosed luminaires

**WARRANTY:**

5-year standard warranty  
(further details available at [www.maxlite.com/warranties](http://www.maxlite.com/warranties))

MODEL SELECTION (Full list of order codes on pg. 2)		Typical order example: 17BR40DLED27/G3	
		DLED	
FAMILY		DIMMABILITY	COLOR TEMPERATURE (CCT)
<b>7BR20</b> = 7 watts, BR20 <b>8BR30</b> = 8 watts, BR30 <b>11BR30</b> = 11 watts, BR30 <b>12BR40</b> = 12 watts, BR40 <b>17BR40</b> = 17 watts, BR40		DLED = Dimmable	<b>27/G3</b> = 2700K <b>30/G3</b> = 3000K <b>40/G3</b> = 4000K <b>50/G3</b> = 5000K*

NOTES:  
1. Bulk pack and 4 pack are available. See Ordering Table on Page 2.  
\* 5000K model only available for 8BR30DLED50/G3

**COMPATIBLE DIMMERS:**

MAKE	DIMMER MODEL	MAKE	DIMMER MODEL
Lutron	CTCL-153P	Leviton	IPL06
Lutron	DVCL-153P	Leviton	IP110
Lutron	LGCL-153P	Leviton	6631-LW
Lutron	S-600	Leviton	6683-IW

This device complies with Part 15 of the FCC Rules. Operation is subject to the following two conditions:  
(1) This device may not cause harmful interference.  
(2) This device must accept any interference received, including interference that may cause undesired operation.

**SPECIFICATIONS:**

ITEM	SPECIFICATION	BR20		BR30		BR40	
		7 WATTS	8 WATTS	11 WATTS	12 WATTS	17 WATTS	
<b>GENERAL PERFORMANCE</b>	Color Temperature	2700K, 3000K, 4000K	2700K, 3000K, 4000K, 5000K	2700K, 3000K, 4000K	2700K, 3000K, 4000K	2700K, 3000K, 4000K	
	Lumens Delivered (lm)	550	650	850	1050	1400	
	Efficacy (lm/W)	79	81	77	88	82	
	Equivalency	50W	65W	65W	75W	100W	
	Lumen Maintenance (L70)	25,000 hours					
<b>ELECTRICAL</b>	Power Factor	≥.70					
	Input Voltage	120V					
<b>PHYSICAL</b>	Operating Temperature	-4°F to 104°F					
<b>APPLICATION</b>	Environment	Dry, Damp					
	Warranty	5 year standard warranty					

**ORDERING:**

ORDER CODE	MODEL	ENERGY STAR	WATTAGE	INCANDESCENT EQUIVALENCY	CRI	OUTPUT (LUMENS)	DIMENSIONS H" X W"	CCT
<b>BR20</b>								
14099046	7BR20DLED27/G3	★	7W	50W	82	550	3.8" x 2.5"	2700K
14099047	7BR20DLED30/G3	★	7W	50W	82	550	3.8" x 2.5"	3000K
14099048	7BR20DLED40/G3	★	7W	50W	84	550	3.8" x 2.5"	4000K
<b>BR30</b>								
14099049	8BR30DLED27/G3	★	8W	65W	82	650	5.10" x 3.75"	2700K
14099158	8BR30DLED27/G3/4P (4-Pack)	★	8W	65W	82	650	5.10" x 3.75"	2700K
14099159	8BR30DLED27/G3/BP (Bulk Pack)	★	8W	65W	82	650	5.10" x 3.75"	2700K
14099050	8BR30DLED30/G3	★	8W	65W	82	650	5.10" x 3.75"	3000K
14099051	8BR30DLED40/G3	★	8W	65W	84	650	5.10" x 3.75"	4000K
14099657	8BR30DLED50/G3	★	8W	65W	84	650	5.10" x 3.75"	5000K
14099421	11BR30DLED27/G3	★	11W	65W	82	850	5.10" x 3.75"	2700K
14099422	11BR30DLED27/G3/BP	★	11W	65W	82	850	5.10" x 3.75"	2700K
14099423	11BR30DLED30/G3	★	11W	65W	82	850	5.10" x 3.75"	3000K
14099424	11BR30DLED40/G3	★	11W	65W	84	850	5.10" x 3.75"	4000K
<b>BR40</b>								
14099052	12BR40DLED27/G3	★	12W	75W	82	1050	6.25" x 4.75"	2700K
14099417	12BR40DLED27/G3/BP	★	12W	75W	82	1050	6.25" x 4.75"	2700K
14099053	12BR40DLED30/G3	★	12W	75W	84	1050	6.25" x 4.75"	3000K
14099054	12BR40DLED40/G3	★	12W	75W	84	1050	6.25" x 4.75"	4000K
14099418	17BR40DLED27/G3	★	17W	100W	82	1400	6.25" x 4.75"	2700K
14099419	17BR40DLED30/G3	★	17W	100W	82	1400	6.25" x 4.75"	3000K
14099420	17BR40DLED40/G3	★	17W	100W	84	1400	6.25" x 4.75"	4000K

★ ENERGY STAR Certified



**LED PL RETROFIT LAMPS**  
PL SERIES



**PRODUCT DESCRIPTION:**

The six- and eight-watt LED PL Lamps are available in GU24, E26 as well as GX23 and G24q pin base options to replace inefficient 13- and 18-watt compact fluorescents lamps (CFLs). The LED PL lamps ensure a long 50,000-hour lifetime, and deliver an 82 CRI with uniform consistency compared to CFLs. The lamps operate on a 120-277 volt system to easily retrofit into a variety of residential applications, including recessed cans, sconces, and ceiling fixtures.

**FEATURES:**

- Universal voltage: 120V-277V applications
- Output ranges from 570 - 960 lumens
- Color Rendering Index (CRI): ≥82
- 50,000 hour life
- High power factor: ≥0.90
- Rotatable 270°
- Simple ballast bypass ensures maintenance-free operation
- Instant on
- Non dimmable
- Suitable for dry and damp locations
- Not intended for use with emergency exits
- UL Listed (E26 & GU24 base), UL Classified (GX23 & G24q)
- Enclosed Rated fixtures

**APPLICATIONS:**

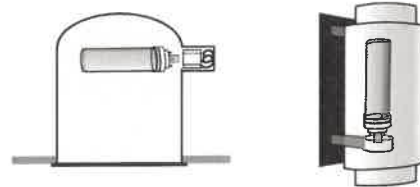

\*See BASES on page 3

**WARRANTY:**

5-year standard warranty  
(further details available at [www.maxlite.com/warranties](http://www.maxlite.com/warranties))  
Product may be eligible for a warranty extension to 10 years, for an additional fee. Contact MaxLite for details.

MODEL SELECTION (Full list of order codes on pg. 2 & 3)		Typical order example: 8PLG24QLED40	
WATTAGE	PL FAMILY	BASE	CCT
6= 6 watts 8= 8 watts	PL	GX23LED= GX23 2-pin G24QLED= G24q 4-pin GU24LED= GU24 twist & lock E26LED= E26 screw base*	27= 2700K (All base type) 30= 3000K (G24Q, GU24, E26 Only) 35= 3500K (GX23, G24Q Only) 40= 4000K (GX23, G24Q, GU24 Only) 50= 5000K (GX23, G24Q Only)

**\* SEE ORDERING TABLE FOR AVAILABLE MODELS**

This device complies with Part 15 of the FCC Rules. Operation is subject to the following two conditions:  
(1) This device may not cause harmful interference.  
(2) This device must accept any interference received, including interference that may cause undesired operation.

**SPECIFICATIONS:**

ITEM	SPECIFICATION	6 WATTS - DETAILS					8 WATTS - DETAILS				
GENERAL PERFORMANCE	Color Temperature	2700K	3000K	3500K	4000K	5000K	2700K	3000K	3500K	4000K	5000K
	Lumens Delivered (lm)	570	570	600	600	600	920	920	960	960	960
	Efficacy (lm/w)	95	95	100	100	100	115	115	120	120	120
	Lumen Maintenance (L70)	50,000 hours									
ELECTRICAL	Power Factor	≥.90									
	Input Voltage	120V-277V									
PHYSICAL	Operating Temperature	-4° F to 113° F									
APPLICATION	Environment	Dry & Damp									
	Warranty	5 Year standard warranty									

**ORDERING\*:**

ORDER CODE	WATTAGE	MODEL	EQUIVALENCY	OUTPUT (LUMENS)	DIMENSIONS	CCT
<b>GX23 BASE (2-PIN)</b>						
76616	6	6PLGX23LED27	13W CFL	570	5.79" x 1.38"	2700K
76617	6	6PLGX23LED35	13W CFL	600	5.79" x 1.38"	3500K
76618	6	6PLGX23LED40	13W CFL	600	5.79" x 1.38"	4000K
76619	6	6PLGX23LED50	13W CFL	600	5.79" x 1.38"	5000K
76625	8	8PLGX23LED27	18W CFL	920	6.75" x 1.38"	2700K
76626	8	8PLGX23LED35	18W CFL	960	6.75" x 1.38"	3500K
76627	8	8PLGX23LED40	18W CFL	960	6.75" x 1.38"	4000K
76628	8	8PLGX23LED50	18W CFL	960	6.75" x 1.38"	5000K
<b>G24Q BASE (4-PIN)</b>						
76608	6	6PLG24QLED27	13W CFL	570	5.50" x 1.38"	2700K
76609	6	6PLG24QLED30	13W CFL	570	5.50" x 1.38"	3000K
76610	6	6PLG24QLED35	13W CFL	600	5.50" x 1.38"	3500K
76611	6	6PLG24QLED40	13W CFL	600	5.50" x 1.38"	4000K
76612	6	6PLG24QLED50	13W CFL	600	5.50" x 1.38"	5000K
76488	8	8PLG24QLED27	18W CFL	920	6.50" x 1.38"	2700K
76489	8	8PLG24QLED30	18W CFL	920	6.50" x 1.38"	3000K
76490	8	8PLG24QLED35	18W CFL	960	6.50" x 1.38"	3500K
76491	8	8PLG24QLED40	18W CFL	960	6.50" x 1.38"	4000K
76492	8	8PLG24QLED50	18W CFL	960	6.50" x 1.38"	5000K
<b>GU24 BASE</b>						
76613	6	6PLGU24LED27	13W CFL	570	5.38" x 1.38"	2700K
76614	6	6PLGU24LED30	13W CFL	570	5.38" x 1.38"	3000K
76615	6	6PLGU24LED40	13W CFL	600	5.38" x 1.38"	4000K
76622	8	8PLGU24LED27	18W CFL	920	6.40" x 1.38"	2700K
76623	8	8PLGU24LED30	18W CFL	920	6.40" x 1.38"	3000K
76624	8	8PLGU24LED40	18W CFL	960	6.40" x 1.38"	4000K

Lighting layouts and spacing criteria available upon request

**ORDERING\*:**

ORDER CODE	WATTAGE	MODEL	EQUIVALENCY	OUTPUT (LUMENS)	DIMENSIONS	CCT
<b>E26 BASE</b>						
76606	6	6PLE26LED27	13W CFL	570	5.88" x 1.38"	2700K
76607	6	6PLE26LED30	13W CFL	570	5.88" x 1.38"	3000K
76620	8	8PLE26LED27	18W CFL	920	6.88" x 1.38"	2700K
76621	8	8PLE26LED30	18W CFL	920	6.88" x 1.38"	3000K

Lighting layouts and spacing criteria available upon request

**BASES:**

Our GX23 base lamps will fit into the following sockets:

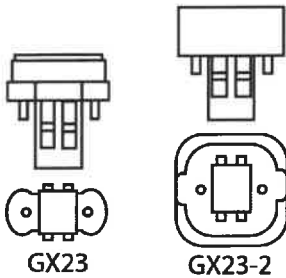

Our G24q base lamps will fit into the following sockets:

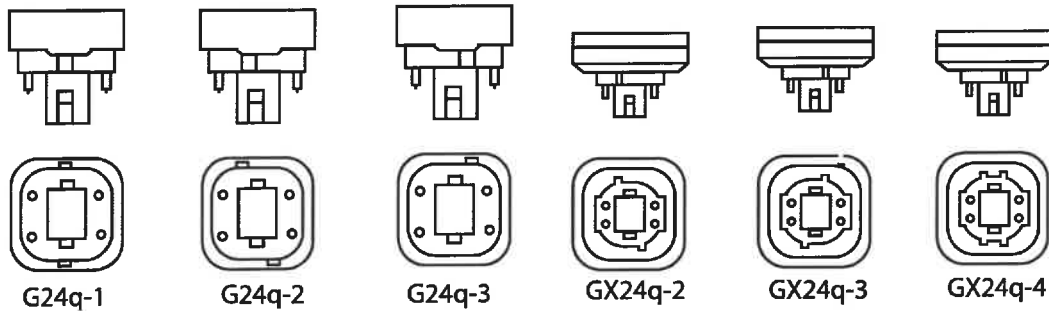

**LED T8 - LINEAR REPLACEMENT LAMP**  
DUAL-MODE/HYBRID SERIES UL TYPE A+B



Intertek



**FEATURES:**

- Wattage:
  - 9W, 2FT, ≥1350 lumens, replaces 17W fluorescent T8
  - 11W, 3FT, ≥1,600 lumens, replaces 25W fluorescent T8
  - 12W, 4FT, ≥1,800 lumens, replaces 32W fluorescent T8
- Voltage (UL TYPE-B): 120V-277V applications
- Color Rendering Index (CRI): ≥83
- Beam angle: 330°
- THD <20%
- Power factor: ≥ 0.90
- Dual Mode: Can be used with compatible fluorescent ballast (UL-A) and ballast bypass (UL-B)
- Ballast bypass (UL-B): Can be wired for single-ended power or double-ended power.
- Compatible with shunted and non-shunted lamp holders
- Instant on
- Mercury free and virtually no UV or IR light
- Dimmable when used with compatible dimming ballast (UL-A)
- Suitable for enclosed fixture
- Suitable for dry and damp locations
- ETL Sanitation listed (tested under NSF standard)
- All glass construction with PET coating
- Rated Lifetime @ L70: 50,000 Hours

**PRODUCT DESCRIPTION:**

MaxLite offers a safer, more reliable alternative to the dual-mode lamps on the market with the new Hybrid Series UL Type A/B LED T8 Lamp. Designed as a universal solution, the Hybrid Series lamp can be used with a compatible fluorescent ballast (UL-A) or ballast bypass (UL-B). Unlike competitors' lamps, the MaxLite product features improved integrated circuit (IC) technology that detects the lamp connection and corresponding operating mode. Each pin at the lamp base is engineered with a thermal fuse that detects overheating and responds by automatically shutting the lamp off. In addition, the lamp is packaged with a re-lamping label that provides a clear wiring description to help maintenance staff easily identify fixture modifications in the field. The MaxLite T8 also offers more robust ballast compatibility than competitors, including instant start, programmed start, emergency and dimming ballast compatibilities.

**WARRANTY:**

5-year standard warranty  
(further details available at [www.maxlite.com/warranties](http://www.maxlite.com/warranties))  
Product may be eligible for a warranty extension to 10 years, for an additional fee. Contact MaxLite for details.

MODEL SELECTION (Full list of order codes on pg. 2)					Typical order example: L9T8AB235-CG	
L	9	T8	AB	2		
FAMILY	WATTAGE	LAMP TYPE	OPERATION	LENGTH	COLOR TEMPERATURE	
L= LED Linear	9= 9W	T8= T8 tube	AB= Dual Mode A+B	2= 2FT	<b>35-CG=</b> 3500K, Coated Glass <b>40-CG=</b> 4000K, Coated Glass <b>50-CG=</b> 5000K, Coated Glass	
L	11	T8	AB	3		
FAMILY	WATTAGE	LAMP TYPE	OPERATION	LENGTH	COLOR TEMPERATURE	
L= LED Linear	11= 11W	T8= T8 tube	AB= Dual Mode A+B	3= 3FT	<b>35-CG=</b> 3500K, Coated Glass <b>40-CG=</b> 4000K, Coated Glass <b>50-CG=</b> 5000K, Coated Glass	
L	12	T8	AB	4		
FAMILY	WATTAGE	LAMP TYPE	OPERATION	LENGTH	COLOR TEMPERATURE	
L= LED Linear	12= 12W	T8= T8 tube	AB= Dual Mode A+B	4= 4FT	<b>35-CG=</b> 3500K, Coated Glass <b>40-CG=</b> 4000K, Coated Glass <b>50-CG=</b> 5000K, Coated Glass	

Specifications are subject to change without notice.



**SPECIFICATIONS:**

		L9T8AB2XX-CG	L11T8AB3XX-CG	L12T8AB4XX-CG
ITEM	SPECIFICATION	2FT - DETAILS	3FT - DETAILS	4FT - DETAILS
<b>GENERAL PERFORMANCE</b>	Bare Lamp Power (W)	8.5W	11.5W	12W
	System (UL-A) Power (W)	12W	14W	15.5W
	Bypass (UL-B) Power (W)	9W	12W	13W
	Lumens Delivered (lm)	1350-1420	1600-1650	1800-1900
	Efficacy (UL-A)	113-118 lm/w	114-118 lm/w	116-123 lm/w
	CRI	≥83		
	Beam Angle	330°		
	Color Temperature (CCT)	3500K, 4000K, 5000K		
	Lumen Maintenance (L70)	50,000 Hours		
<b>ELECTRICAL</b>	Power Factor	≥ 0.90		
	Input Voltage	120V-277V, 50/60 Hz		
<b>PHYSICAL</b>	Operating Temperature	-4°F to 113°F		
	Lens	Opal (Frosted) - Coated Glass		
<b>CERTIFICATION</b>	Certification	UL, CULus Classified, ETL Sanitation		
	Material Usage	RoHS compliant; no mercury		
	Environment	Dry & Damp, Enclosed Fixtures		
	Warranty	5 year standard warranty		
<b>QUALIFICATION</b>	DesignLight Consortium	DLC Listed		

Lighting layouts and spacing criteria available upon request

**ORDERING:**

MODELS	DLC PRODUCT ID	BARE LAMP POWER (W)	SYSTEM (UL-A) POWER (W)	BYPASS (UL-B) POWER (W)	LUMENS (lm)	EFFICACY (lm/W)	CCT
<b>9W 2FT T8 MODELS</b>							
L9T8AB235-CG	PLSRNHV1JP1G	8.5W	12W	9W	1350	112 lm/W	3500K
L9T8AB240-CG	PL965FLVCC6A				1380	115 lm/W	4000K
L9T8AB250-CG	PLGDCFYKD348				1420	118 lm/W	5000K
<b>11W 3FT T8 MODELS</b>							
L11T8AB335-CG	PLGK52GQNL1N	11.5W	14W	12W	1600	114 lm/W	3500K
L11T8AB340-CG	PLKRUONGV9SD				1625	116 lm/W	4000K
L11T8AB350-CG	PLLQF8KE9PIZ				1650	118 lm/W	5000K
<b>12W 4FT T8 MODELS</b>							
L12T8AB435-CG	PLF6U1JY4KRM	12W	15.5W	13W	1800	116 lm/W	3500K
L12T8AB440-CG	PLONWYTS0ZZR				1900	123 lm/W	4000K
L12T8AB450-CG	PLVXLG8KIZUW				1900	123 lm/W	5000K

Specifications are subject to change without notice.

**BALLAST COMPATIBILITY LIST:**

BALLAST DESCRIPTION				1 LAMP LOAD		2 LAMPS LOAD		3 LAMPS LOAD		4 LAMPS LOAD		REMARK	
BRAND	MODEL	START METHOD	# OF LAMPS	INPUT VOLTAGE		INPUT VOLTAGE		INPUT VOLTAGE		INPUT VOLTAGE		DIMMING	BALLAST VERSION
				120 V	277V	120 V	277V	120 V	277V	120 V	277V		
Arcata	ACT2P32ISUNV	IS	2	✓	✓	✓	✓	-	-	-	-	/	/
	ACT4P32ISUNV	IS	4	-	-	-	-	✓	✓	✓	✓	/	/
Advance	ICN-2P32-N	IS	2	X	X	✓	✓	-	-	-	-	/	REV C/E
	ICN-3P32-N	IS	3	-	-	✓	✓	✓	✓	-	-	/	REV D
	ICN-2P32-SC	IS	2	✓	✓	✓	✓	-	-	-	-	/	/
	IOPA-1P32-N	IS	1	✓	✓	-	-	-	-	-	-	/	REV B
	IOPA-2P32-N	IS	2	X	X	✓	✓	-	-	-	-	/	REV A
	IOPA-3P32-N	IS	3	-	-	✓	✓	✓	✓	-	-	/	REV B
	IOPA-1P32-LW-N	IS	1	X	X	-	-	-	-	-	-	/	REV A
	IOPA-2P32-LW-N	IS	2	X	X	✓	✓	-	-	-	-	/	REV B
	IOPA-4P32-LW-N	IS	4	-	-	-	-	✓	✓	✓	✓	/	REV A
	REL-2P32-SC	IS	2	✓	-	✓	-	-	-	-	-	/	/
	ICN-4P32-SC	IS	4	-	-	-	-	✓	✓	✓	✓	/	REV D
	ESPEN	VE232MVHIPHE	IS	2	X	X	✓	✓	-	-	-	-	/
VE232MVHIPLE		IS	2	✓	✓	✓	✓	-	-	-	-	/	/
VE432MVHIP		IS	4	-	-	-	-	✓	✓	✓	✓	/	/
VE432MVHIPE		IS	4	-	-	-	-	✓	✓	✓	✓	/	/
Fulham	NPY-120-232-LT8	PS	2	X	-	X	-	-	-	-	-	/	/
	NPY-120-432-T8B	IS	4	-	-	-	-	✓	-	✓	-	/	/
	NPY-120-432-T8-IS	IS	4	-	-	-	-	✓	-	✓	-	/	/
	WHCG3-120-T8-IS	IS	3	-	-	✓	-	✓	-	-	-	/	/
	WH2-120-L	IS	1	✓	-	-	-	-	-	-	-	/	/
	WH5-120-L	IS	4	-	-	-	-	✓	-	✓	-	/	/
Fusion	FB232MVE	IS	2	✓	✓	✓	✓	-	-	-	-	/	/
	FB232MVE-N	IS	2	✓	✓	✓	✓	-	-	-	-	/	/
	FB232MVE-HE	IS	2	✓	✓	✓	✓	-	-	-	-	/	/
	FB232MVE-LHE	IS	2	✓	-	✓	-	-	-	-	-	/	/
	FB232MVE-PPS-HE	PS	2	✓	✓	✓	✓	-	-	-	-	/	/
	FB332MVE	IS	3	-	-	✓	✓	✓	✓	-	-	/	/
	FB432MVE	IS	4	-	-	-	-	✓	✓	✓	✓	/	/
	FB432MVE-HE	IS	4	-	-	-	-	✓	✓	✓	✓	/	/
	FB432MVE-N	IS	4	-	-	-	-	✓	✓	✓	✓	/	/
FB432MVE-PPS-HE	PS	4	-	-	-	-	✓	✓	✓	✓	/	/	
GE	GE 232-120-PS-N	PS	2	✓	-	✓	-	-	-	-	-	/	/
	GE232MAXP-N/ULTRA	IS	2	✓	✓	✓	✓	-	-	-	-	/	/
	GE232MAXP-H/ULTRA	IS	2	X	X	✓	✓	-	-	-	-	/	/
	GE232-MVPS-L	PS	2	✓	✓	✓	✓	-	-	-	-	/	/
	GE232-MVPS-H	PS	2	X	X	✓	✓	-	-	-	-	/	/

Specifications are subject to change without notice.

### BALLAST COMPATIBILITY LIST:

BALLAST DESCRIPTION				1 LAMP LOAD		2 LAMPS LOAD		3 LAMPS LOAD		4 LAMPS LOAD		REMARK	
BRAND	MODEL	START METHOD	# OF LAMPS	INPUT VOLTAGE		INPUT VOLTAGE		INPUT VOLTAGE		INPUT VOLTAGE		DIMMING	BALLAST VERSION
				120 V	277V	120 V	277V	120 V	277V	120 V	277V		
GE	GE332MAX-L/ULTRA	IS	3	-	-	✓	✓	✓	✓			/	/
	GE332MAX90-V60	IS	3	-	-	X	X	✓	✓	-	-	Dimming	/
	GE332MV-N-DIY	IS	3	-	-	✓	✓	✓	✓	-	-	/	/
	GE432-120-N	IS	4	-	-	-	-	✓	-	✓	-	/	/
	GE432MAX-G-N	IS	4	-	-	-	-	✓	✓	✓	✓	/	/
	GE432MAX-H-42T	IS	4	-	-	-	-	✓	✓	✓	✓	/	/
	GE432MV-N-DIY	IS	4	-	-	-	-	✓	✓	✓	✓	/	/
Greenhill	GH4P32ISUNV	IS	4	-	-	-	-	✓	✓	✓	✓	/	/
Halco	EP332IS/MV/MC	IS	3	-	-	✓	✓	✓	✓	-	-	/	/
	EP432IS/L/MV/HE	IS	4	-	-	-	-	✓	✓	✓	✓	/	/
	EP432IS/MV/MC	IS	4	-	-	-	-	✓	✓	✓	✓	/	/
HOWARD	EP4/32IS/MV/MC/HE	IS	4	-	-	-	-	✓	✓	✓	✓	/	/
Huafeng	ENI-T8-32-P2SC-N	IS	2	✓	✓	✓	✓	-	-	-	-	/	/
	ENI-T8-32-P4MC-N	IS	4	-	-	-	-	X	✓	X	✓	/	/
KEYSTONE	KTEB-232-UV-IS-N-P	IS	2	✓	✓	✓	✓	-	-	-	-	/	Version D1
	KTEB-232-UV-PS-VDIM	PS	2	-	-	✓	✓	-	-	-	-	Dimming	/
	KTEB-332-UV-IS-N-P	IS	3	-	-	✓	✓	✓	✓	-	-	/	Version B
	KTEB-432-UV-IS-N-P	IS	4	-	-	-	-	✓	✓	✓	✓	/	Version A1
Osram	QHE 2x32T8/UNV DIM-TC	PS	2	-	-	✓	✓	-	-	-	-	Dimming	/
	QTP 4x32T8/UNV ISN-SC	IS	4	-	-	-	-	✓	✓	✓	✓	/	/
Pacific	EB-332IS-U	IS	3	-	-	✓	✓	✓	✓	-	-	/	/
	EB-432IS-U	IS	4	-	-	-	-	✓	✓	✓	✓	/	/
PQL	70201	IS	2	✓	✓	✓	✓	-	-	-	-	/	/
	70204	IS	4	-	-	-	-	✓	✓	✓	✓	/	/
Premium	BB-T8/UVH-2x32	IS	2	✓	✓	✓	✓	-	-	-	-	/	/
	BB-T8/UVH-3x32	IS	3	-	-	-	-	✓	✓	-	-	/	/
Robertson	RSW240T12120	PS	2	✓	-	✓	-	-	-	-	-	/	/
Standard	E232P1120L	IS	2	✓	-	✓	-	-	-	-	-	/	/
	E432T8IS120/H	IS	4	-	-	-	-	X	-	✓	-	/	/
	E432T8IS120/N/AS/BULK	IS	4	-	-	-	-	✓	-	✓	-	/	/
Sunpark	SL15T	PS	2	X	-	✓	-	-	-	-	-	/	/
Universal	B232PUSV3PLA	PS	2	X	X	X	X	-	-	-	-	Dimming	REV A
	B232SR120S30	PS	2	-	-	X	-	-	-	-	-	Dimming	REV E
	B432IUNVHP-A	IS	4	-	-	-	-	✓	✓	✓	✓	/	REV B



**BALLAST COMPATIBILITY LIST:**

BALLAST DESCRIPTION				1 LAMP LOAD		2 LAMPS LOAD		3 LAMPS LOAD		4 LAMPS LOAD		REMARK	
BRAND	MODEL	START METHOD	# OF LAMPS	INPUT VOLTAGE		INPUT VOLTAGE		INPUT VOLTAGE		INPUT VOLTAGE		DIMMING	BALLAST VERSION
				347V	480V	347V	480V	347V	480V	347V	480V		
Arcata	ACT2P32IS347	IS	2	✓	✓	✓	✓	-	-	-	-	/	/
	ACT4P32IS347	IS	4	-	-	-	-	✓	✓	✓	✓	/	/
Advance	GOPA-2P32-LW-SC	IS	2	✓	-	✓	-	-	-	-	-	/	REV D
	GOPA-4P32-LW-SC	IS	4	-	-	-	-	✓	-	✓	-	/	REV D
	GOPA-2P32-SC	IS	2	✓	-	✓	-	-	-	-	-	/	REV C
	GOPA-4P32-SC	IS	4	-	-	-	-	✓	-	✓	-	/	REV D
Fusion	FB232347E-HE	IS	2	✓	-	✓	-	-	-	-	-	/	/
	FB232347E-L	IS	2	✓	-	✓	-	-	-	-	-	/	/
	FB232347E-N	IS	2	✓	-	✓	-	-	-	-	-	/	/
	FB232347E-PPS-HE	PS	2	✓	-	✓	-	-	-	-	-	/	/
	FB432347E-HE	IS	4	-	-	-	-	✓	-	✓	-	/	/
	FB432347E-L	IS	4	-	-	-	-	✓	-	✓	-	/	/
	FB432347E-N	IS	4	-	-	-	-	✓	-	✓	-	/	/
	FB432347E-PPS-HE	PS	4	-	-	-	-	✓	-	✓	-	/	/
GE	GE232MAX347-H	IS	2	✗	-	✓	-	-	-	-	-	/	/
	GE232PS347-N	PS	2	✓	-	✓	-	-	-	-	-	/	/
	GE332MAX347-H	IS	3	-	-	✗	-	✓	-	-	-	/	/
	GE432MAX347-H	IS	4	-	-	-	-	✗	-	✓	-	/	/
	GE432PS347-N	PS	4	-	-	-	-	✓	-	✓	-	/	/
OSRAM	QHE 2x32 T8/347 ISL-SC	IS	2	✓	-	✓	-	-	-	-	-	/	/
	QHE 2x32 T8/347 ISN-SC	IS	2	✓	-	✓	-	-	-	-	-	/	/
Standard	E232T8IS347/H/90C	IS	2	✗	-	✗	-	-	-	-	-	/	/
	E232T8IS347/L/BULK	IS	2	✓	-	✓	-	-	-	-	-	/	/
	E232T8IS347/N/BULK	IS	2	✓	-	✓	-	-	-	-	-	/	/
	E432PI347G01	IS	4	-	-	-	-	✓	-	✓	-	/	/
	E432T8IS347/L/BULK	IS	4	-	-	-	-	✓	-	✓	-	/	/
	E432T8IS347/N	IS	4	-	-	-	-	✓	-	✓	-	/	/
	E432T8IS347/N/BULK	IS	4	-	-	-	-	✓	-	✓	-	/	/
E432T8IS347/H/90C	IS	4	-	-	-	-	✓	-	✗	-	/	/	
Universal	B232I347HE-A	IS	2	✓	-	✓	-	-	-	-	-	/	/
	B432I347HE-A	IS	4	-	-	-	-	✓	-	✓	-	/	/

EMERGENCY BALLAST		COMPATIBLE
BRAND	PART NUMBER	
Keystone	KT-EMRG-500	✓
	KT-EMRG-750-CFL4	✓
	KT-EMRG-1300-T5	✓
IOTA	ISL-54	✓

Specifications are subject to change without notice.



## Exhibit "F" – Completed Projects



## Aquila Projects in Progress

### *Public School District Projects*

Shawn Drake  
Energy Manager  
Hobbs Municipal School  
New Mexico  
C: 575-433-0100



- Maintenance free for the system's useful life of 19.9 years
- Projected \$166,837 in annual savings
- \$1.7MM net savings over system's useful life
- Procured a \$260,000 rebate through this project

Dr. Randy Burks  
Superintendent  
Hamlin ISD  
Hamlin, Texas  
W: 325-576-2722



**HAMLIN COLLEGIATE**  
INDEPENDENT SCHOOL DISTRICT

- Maintenance free for the system's useful life of 19.32 years
- Projected \$37,939 in annual savings
- \$472,836 net savings over system's useful life



## Completed Aquila Projects *Public School District Projects*

Kellie Spencer  
Chief Operations Officer  
Midland ISD  
Region 18  
C: 432-240-1000



- Maintenance free for the system's useful life of 20.54 years
- *Projected \$514,967 in annual savings*
- \$8.2MM net savings over system's useful life

Lance Terrell  
Ex-Chief Financial Officer  
Levelland ISD  
Region 17  
C: 806-367-0085



- Maintenance free for the system's useful life of 20+ years
- 22% decrease in kWh in first year
- Projected \$98,000 in annual savings
- More than \$125,000 decrease in energy expenditure in first year
- \$1.26MM net savings over system's useful life

Lance Rainey  
Chief Financial Officer  
Melissa ISD  
Region 10  
W: 972-369-6385  
lrainey@melissaisd.org



- Maintenance free system for its useful life
- \$102,260 Actual Savings over 16 months
- \$1.01MM net savings over system's useful life

509 E. Pecan Street, Suite 200  
Fort Worth, TX 76102

AQUILA  
ENVIRONMENTAL



Bryan Ritchey  
Director of Operations  
Seminole ISD  
Region 17  
W: 432-758-3662  
britchey@seminoleisd.net

Jay Lashaway  
Chief Financial Officer  
jlashaway@seminoleisd.net



- Maintenance free system for its useful life of 20 years
- Projected \$168,000 in annual savings
- \$3MM net savings over system's useful life

Frank Molinar  
Superintendent  
White Settlement ISD  
Region 11  
W: 817-367-1300  
fmolinar@wsisd.net

David Bitters  
Assistant Superintendent of  
Finance & Operations  
dbitters@wsisd.net



- Maintenance free system for its useful life of 21 years
- Projected \$126,000 in annual savings
- \$1.8MM net savings over system's useful life
- Procured a \$20,000 rebate through this project

Randy McDowell  
Chief Financial Officer  
Plano ISD  
Region 10

Michelle Hahn  
Operations / Energy Mgr.  
W: 469-752-1590  
michelle.hahn@pisd.edu



**PLANO**  
Independent School District

- Won competitive RFP for exterior lighting
- Maintenance free system for its useful life of 20 years



Dr. Rich Dear  
Superintendent  
Godley ISD  
Region 11  
W: 817-389-2536  
cdear@godleyisd.net

Bryan Myres  
Executive Director - Finance  
bmyres@godleyisd.net  
817-592-4161



- Maintenance free system for its useful life of 20 years
- Projected \$88,000 in annual savings
- \$1.3MM net savings over system's useful life

Dr. Elizabeth Anita Auevonus  
Superintendent  
Milano ISD  
Region 6  
C: 512-455-2533



- Maintenance free for the system's useful life of 19.7 years
- Projected \$25,749 in annual savings
- \$390,428 net savings over system's useful life

E. Ariel Elliott  
Superintendent  
Greenwood ISD  
Region 18  
elliott@greenwood.esc18.net

Darrell Dodds  
Former - Chief Financial Officer  
Current - Midland ISD  
CFO  
W: 432-240-1017  
darrell.dodds@midlandisd.net



- Maintenance free system for its useful life of 21 years
- Projected \$97,000 in annual savings
- \$1.59MM net savings over system's useful life



Liz Poage  
Chief Financial Officer  
Lamesa ISD  
Region 17  
W: 806-872-5461  
lpoage@lamesa.esc17.net

Jim Knight  
Superintendent  
jknight@lamesa.esc17.net



- Maintenance free system for its useful life of 21 years
- Projected \$91,000 in annual savings
- \$1.5MM net savings over system's useful life

Summer Mathis  
Chief Financial Officer  
Paradise ISD  
Region 11  
W: 940-969-5004  
smathis@pisd.net

Dr. Paul Uttley  
Superintendent  
puttley@pisd.net



- Maintenance free system for its useful life of 20 years
- Actualized reduction of 264,094 kWh in six months
- \$1.09MM net savings over system's useful life
- Procured a \$10,000 rebate through our project

Trevor Rogers  
Superintendent  
Lindsay ISD  
Region 11  
W: 940-668-8923  
trogers@lindsayisd.org



- Maintenance free system for its useful life of 19 years
- Projected \$35,000 in annual savings
- \$560,000 net savings over systems useful life

509 E. Pecan Street, Suite 200  
Fort Worth, TX 76102

AQUILA  
ENVIRONMENTAL





Aaron Waldrip  
Superintendent  
Abernathy ISD  
Region 17  
W: 806-298-4940  
amwaldrip@abernathyisd.com



- Maintenance free system for its useful life of 20 years
- Projected \$67,000 in annual savings
- \$1,102,000 net savings over systems useful life
- District received \$63,000 at commencement through rebates and labor program

Tucker Durham  
Former Chief Financial Officer  
Alpine ISD  
Region 18  
W: 432-837-7700



- Maintenance free system for its useful life of 20 years
- Projected \$24,000 in annual savings
- \$472,000 net savings over systems useful life
- Helped procure a \$2,000 rebate through this project.

Dane Kerns  
Former Superintendent  
Smyer ISD  
Region 17  
W: 806-234-2935



- Maintenance free system for its useful life of 19 years
- Projected \$28,000 in annual savings
- \$415,000 net savings over system's useful life



Dr. Lynn Pulliam  
Superintendent  
Canadian ISD  
Region 16  
W: 806-323-5393  
lynn.pulliam@canadianisd.net

- Maintenance free system for its useful life of 20 years
- Projected \$30,000 in annual savings
- \$602,000 net savings over systems useful life

Craig Hamilton  
Superintendent  
Spur ISD  
Region 17  
W: 806-271-3272 ext:2001  
chamilton@esc17.net

- Maintenance free system for its useful life of 18 years
- Projected \$31,000 in annual savings
- \$417,000 net savings over systems useful life

Chris Wade – Current Superintendent at Smyer ISD  
Former Superintendent  
Ralls ISD  
Region 17  
W: 806-253-2500 ext:4101

- Maintenance free system for its useful life of 19 years
- Projected \$33,000 in annual savings
- \$500,000 net savings over systems useful life
- Procured a \$18,000 rebate through this project



**Every Child, Every Day**



509 E. Pecan Street, Suite 200  
Fort Worth, TX 76102

**AQUILA**  
ENVIRONMENTAL



Kim Edwards  
Superintendent  
Meridian ISD  
Region 12  
W: 254-435-2081  
kedwards@meridianisd.org



- Maintenance free system for its useful life of 19.5 years
- Projected \$67,000 in annual savings
- \$785,000 net savings over systems useful life

Mike Thompson  
Superintendent  
Ranger ISD  
Region 14  
W: 254-647-1187  
mthompson@ranger.esc14.net



- Maintenance free system for its useful life of 20 years
- Projected \$31,000 in annual savings
- \$469,000 net savings over systems useful life

Brandon Cope  
Superintendent  
Riesel ISD  
Region 12  
W: 254-896-5000  
bcope@rieselisd.org



- Maintenance free system for its useful life of 20 years
- Projected \$65,000 in annual savings
- \$1,100,000 net savings over systems useful life
- Procured a \$15,000 rebate through the project



Dr. Ryan Steele  
Superintendent  
Cisco ISD  
Region 14  
W: 254-442-3056  
rsteele@cisco.esc14.net



- Maintenance free system for its useful life of 20 years
- Projected \$65,000 in annual savings
- \$1,101,000 net savings over systems useful life
- Procured a \$18,000 rebate through the project

Scott Lucas  
Superintendent  
White Deer ISD  
Region 16  
W: 806-883-2311 ext:1030  
scott.lucas@region16.net



- Maintenance free system for its useful life of 19.9 years
- Projected \$28,570 in annual savings
- \$444,800 net savings over systems useful life
- Procured a \$14,000 rebate through the project

Lance Terrell  
Chief Financial Officer  
Education Service Center 16  
Region 16  
W: 806-677-5000  
lance.terrell@esc16.net

Ray Cogburn  
Executive Director  
ray.cogburn@esc16.net



- Maintenance free system for its useful life of 21.5 years
- Projected \$32,000 in annual savings
- \$489,400 net savings over system's useful life

509 E. Pecan Street, Suite 200  
Fort Worth, TX 76102





Bill McAllister  
Superintendent  
West Point Public Schools  
West Point, Nebraska  
W: 401-372-5860  
wmcallister@wpcadets.org

- Maintenance free system for its useful life of 20.3 years
- Projected \$43,984 in annual savings
- \$692,180 net savings over systems useful life



Jody Johnson  
Superintendent  
Vega ISD  
Region 16  
W: 806-267-2123  
jody.johnson@regon16.net

- Maintenance free system for its useful life of 19.8 years
- Projected \$24,361 in annual savings
- \$350,655 net savings over systems useful life
- Procured a \$16,000 rebate through the project



Adriana Wolf  
CFO  
Hereford ISD  
Region 16  
W: 806-363-7600  
adrianawolf@herefordisd.net

- Maintenance free system for its useful life of 20.6 years
- Projected \$67,856 in annual savings
- \$960,507 net savings over systems useful life
- Procured a \$25,000 rebate through the project



509 E. Pecan Street, Suite 200  
Fort Worth, TX 76102

AQUILA  
ENVIRONMENTAL



Ritchie Bowling  
Superintendent  
Maypearl ISD  
Region 11  
W: 972-435-1000  
rbowling@maypearlisd.net

- Maintenance free system for its useful life of 19.4 years
- Projected \$57,245 in annual savings
- \$845,919 net savings over systems useful life
- Procured a \$5,000 rebate through the project



Doug Williams  
Superintendent  
Sunnyvale ISD  
Region 10

Dr. Kyle Penn  
CFO  
kyle.penn@sunnyvaleisd.net  
W: 972-226-5974

- Maintenance free system for its useful life of 20.3 years
- Projected \$78,522 in annual savings
- \$1,199,091 net savings over systems useful life
- Procured a \$16,000 rebate through the project



Robert Navarro  
Chief Financial Officer  
Jarrell ISD  
Region 13  
W: 512-746-2124  
Norberto.navarro@jarrellisd.org

- Maintenance free system for its useful life of 20.2 years
- Projected \$76,792 in annual savings
- \$1,195,394 net savings over systems useful life

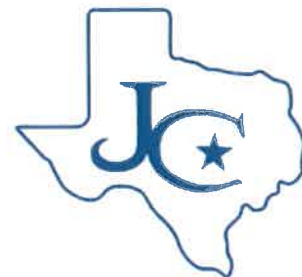





## *Institutional / Private Sector Projects*

David Muzzy, P.E., CEM  
Energy Manager, TCU  
3589 Bellaire Drive North, TCU Box 297800  
Fort Worth, TX 76129  
W: 817-257-4928  
d.muzzy@tcu.edu



- Aquila was selected through a National RFP process to convert the largest building on TCU's campus, the Rickel Recreation Center
- Reduced lighting expenses by ~73%
- Provided annual savings of \$75,938
- \$768,850 net savings over system's useful life
- Procured \$60,000 in rebates through the project

Kenneth White  
AVP Environmental Health, Safety and Sustainability  
GM Financial  
4001 Embarcadero Dr  
Arlington, Tx 76014  
W: 817-525-8021  
kenneth.white@gmfinancial.com



**GM FINANCIAL**

- Savings of 1,121,817 kWh annually
- 10-year Net Savings of \$630,000
- Annual Equipment Savings of \$24,527
- Procured \$75,000 in rebates through the project

Ron Johnson  
Director of Operations  
Prestonwood Christian Academy ("PCA")  
W: 972-820-5120  
ronjohnson@prestonwoodchristian.org



- \$87,000 in annual savings
- \$531,800 net savings over system's useful life

509 E. Pecan Street, Suite 200  
Fort Worth, TX 76102

**AQUILA**  
ENVIRONMENTAL



Buck Raines  
Director of Facilities  
Four Seasons Resort & Club Las Colinas  
4150 N. MacArthur Blvd.  
Irving, TX 75038  
W: 972-717-2402  
buck.raines@fourseasons.com



Gary Milliorn  
VP Property Manager  
First Financial Bank (NASDAQ: FFIN)  
400 Pine Street, 2<sup>nd</sup> floor  
Abilene, Texas 76901  
W: 325-627-7151  
gmilliorn@ffin.com



Chad Cruson – General Manager  
Shady Oaks Country Club  
320 Roaring Springs Road  
Fort Worth, Tx 76114  
W: 817-732-3333  
chad@shadyoaksclub.com



Allen Bell  
Property Manager  
Allen Bell Property Services, Inc.  
100 E. Ferguson Street, Suite 712  
Tyler, Texas 75702  
W: 903-595-2805  
allen@allenbell.com



509 E. Pecan Street, Suite 200  
Fort Worth, TX 76102





Garnett Brookshire  
Plaza Tower  
110 North College Avenue, Ste. 101  
Tyler, Texas 75702  
W: 903-617-6579  
Garnett.brookshire@gmail.com



509 E. Pecan Street, Suite 200  
Fort Worth, TX 76102

**AQUILA**  
ENVIRONMENTAL

# **REQUEST FOR PROPOSAL #R10-1133 FOR: LIGHTING PRODUCTS AND SERVICES**

January 28, 2022

**Section Two:**  
Proposal Submission, Questionnaire and  
Required Forms

Proposal Form Checklist.....	3
PROPOSAL FORM 1: ATTACHMENT B – PRICING .....	4
PROPOSAL FORM 2: QUESTIONNAIRE & EVALUATION CRITERIA .....	5
PROPOSAL FORM 3: CERTIFICATIONS AND LICENSES .....	12
PROPOSAL FORM 4: CLEAN AIR WATER ACT.....	13
PROPOSAL FORM 5: DEBARMENT NOTICE.....	14
PROPOSAL FORM 6: LOBBYING CERTIFICATION.....	15
PROPOSAL FORM 7: CONTRACTOR CERTIFICATION REQUIREMENTS.....	16
PROPOSAL FORM 8: ANTITRUST CERTIFICATION STATEMENTS .....	17
PROPOSAL FORM 9: IMPLEMENTATION OF HOUSE BILL 1295.....	18
PROPOSAL FORM 10: BOYCOTT CERTIFICATION AND TERRORIST STATE CERTIFICATION.....	19
PROPOSAL FORM 11: RESIDENT CERTIFICATION.....	20
PROPOSAL FORM 12: FEDERAL FUNDS CERIFICATION FORM.....	21
PROPOSAL FORM 13: ADDITIONAL ARIZONA CONTRACTOR REQUIREMENTS.....	27
PROPOSAL FORM 14: OWNERSHIP DISCLOSURE FORM (N.J.S. 52:25-24.2).....	29
PROPOSAL FORM 15: NON-COLLUSION AFFIDAVIT .....	30
PROPOSAL FORM 16: AFFIRMATIVE ACTION AFFIDAVIT (P.L. 1975, C.127).....	31
PROPOSAL FORM 17: C. 271 POLITICAL CONTRIBUTION DISCLOSURE FORM.....	34
PROPOSAL FORM 18: STOCKHOLDER DISCLOSURE CERTIFICATION.....	39
PROPOSAL FORM 19: GENERAL TERMS AND CONDITIONS ACCEPTANCE FORM.....	40
PROPOSAL FORM 20: EQUALIS GROUP ADMINISTRATION AGREEMENT .....	41
PROPOSAL FORM 21: OPEN RECORDS POLICY ACKNOWLEDGEMENT AND ACCEPTANCE.....	42
PROPOSAL FORM 22: VENDOR CONTRACT AND SIGNATURE FORM .....	43

# Proposal Form Checklist

## The following documents must be submitted with the Proposal

---

The below documents can be found in Section 2; Proposal Submission and Required Bid Forms and must be submitted with the proposal. Please note Proposal Form 1 is a separate attachment (attachment B).

**PROPOSAL PRICING:** Attachment B is provided separately in a Microsoft Excel file and is required to complete your price proposal.

**PROPOSAL FORM 1: ATTACHMENT B - PRICING**

### QUESTIONNAIRE & EVALUATION CRITERIA:

**PROPOSAL FORM 2: QUESTIONNAIRE & EVALUATION CRITERIA**

### OTHER REQUIRED PROPOSAL FORMS:

**PROPOSAL FORM 3: CERTIFICATIONS AND LICENSES**

**PROPOSAL FORM 4: CLEAN AIR AND WATER ACT**

**PROPOSAL FORM 5: DEBARMENT NOTICE**

**PROPOSAL FORM 6: LOBBYING CERTIFICATION**

**PROPOSAL FORM 7: CONTRACTOR CERTIFICATION REQUIREMENTS**

**PROPOSAL FORM 8: ANTITRUST CERTIFICATION STATEMENTS**

**PROPOSAL FROM 9: IMPLEMENTATION OF HOUSE BILL 1295**

**PROPOSAL FROM 10: BOYCOTT CERTIFICATION AND TERRORIST STATE CERTIFICATION**

**PROPOSAL FORM 11: RESIDENT CERTIFICATION**

**PROPOSAL FORM 12: FEDERAL FUNDS CERIFICATION FORM**

**PROPOSAL FORM 13: ADDITIONAL ARIZONA CONTRACTOR REQUIREMENTS**

**PROPOSAL FORM 14: OWNERSHIP DISCLOSURE FORM (N.J.S. 52:25-24.2)**

**PROPOSAL FORM 15: NON-COLLUSION AFFIDAVIT**

**PROPOSAL FORM 16: AFFIRMATIVE ACTION AFFIDAVIT (P.L. 1975, C.127)**

**PROPOSAL FORM 17: C. 271 POLITICAL CONTRIBUTION DISCLOSURE FORM**

**PROPOSAL FORM 18: STOCKHOLDER DISCLOSURE CERTIFICATION**

**PROPOSAL FORM 19: GENERAL TERMS AND CONDITIONS ACCEPTANCE FORM**

**PROPOSAL FORM 20: EQUALIS GROUP ADMINISTRATION AGREEMENT**

**PROPOSAL FORM 21: OPEN RECORDS POLICY ACKNOWLEDGEMENT AND ACCEPTANCE**

**PROPOSAL FORM 22: VENDOR CONTRACT AND SIGNATURE FORM**

(The rest of this page is intentionally left blank)



**PROPOSAL FORM 1: ATTACHMENT B – PRICING**

Pricing should be entered in the attachment B Excel form provided in this RFP packet. Please reference Section 1, Part B, Instructions to Proposers, for more information on how to complete pricing.

(The rest of this page is intentionally left blank)

**PROPOSAL FORM 2: QUESTIONNAIRE & EVALUATION CRITERIA**

**Instructions:**

Respondents should incorporate their questionnaire responses directly into the green cells below. Failure to provide responses in this format may result in the proposal being deemed as non-responsive at the sole discretion of Region 10.

Respondents may incorporate additional documents as part of their response which may be utilized by Region 10 as part of the evaluation. Additional documents must be consolidated as part of this Section 2 at the end of your response.

Region 10 has associated the evaluation criteria with the question that most closely aligns with that respective evaluation criteria. Region 10 reserves the right at its sole discretion to base its evaluation and specific evaluation criteria on any part of the respondent’s proposal.

Evaluation Criteria	Question	Answer
<b>Basic Information</b>		
Required information for notification of RFP results	<i>What is your company’s official registered name?</i>	Aquila Environmental, LLC
	<i>What is the mailing address of your company’s headquarters?</i>	509 Pecan Street, Suite 200, Fort Worth, Texas 76102
	<i>Who is the main contact for any questions and notifications concerning this RFP response, including notification of award? Provide name, title, email address, and phone number.</i>	Chandan Prasai Director of Project Engineering <a href="mailto:chandan@aquilaenv.com">chandan@aquilaenv.com</a> 817-409-3136
<b>Products/Pricing (30 Points)</b>		
Coverage of products and services	No answer is required. Region 10 will utilize your overall response and the products/services provided in Attachment B to make this determination	
Ability of offered products and services to meet the needs requested in the scope	No answer is required. Region 10 will utilize your overall response and the products/services provided in Attachment B to make this determination	
Pricing for all available products and services, including warranties if applicable	<i>Does the respondent agree to offer all future product and services at prices that are proportionate to contract pricing offered herein?</i>	Yes
	<i>Does pricing submitted include the required administrative fee of 2.25%?</i>	Yes
	<i>Do you offer any other promotions or incentives for customers? If yes, please describe.</i>	No

Ability of Customers to verify that they received contract pricing	<i>Were all products/lines/services and pricing being made available under this contract provided in the attachment B and/or Appendix B, pricing sections?</i>	Yes
	<i>Outline your pricing strategy provided in Attachment B. If utilizing a list price, please indicate where agencies can find the list and your methodology for determining that list price.</i>	Pricing is broken out into materials, labor, and auditing. We will compile all this information into one turnkey price for the district once the audit has been performed.
Payment methods	<i>Define your invoicing process and methods of payments you will accept. Please include the overall process for agencies to make payments</i>	We will only accept wires and checks. The invoicing process is based on the following: 30% of the contract price due within 5 days of the project start, 60% of the contract price due within 30 days of the substantial completion and 10% of the contract price due within 30 days of the punch list completion.
Other factors relevant to this section as submitted by the Respondent	No answer is required. Region 10 will utilize your overall response and the products/services provided in Attachment B to make this determination	
<b>Performance Capability (25 Points)</b>		
Ability to deliver, design, and install products and services	<i>Please outline your products and services being offered, including the features and benefits and how they address the scope being requested herein. Please be specific; your answer to this question, along with products/services provided in your pricing file will be used to evaluate your offering.</i>	We are offering a turnkey service to complete an LED retrofit. We will start with an on-site audit that will involve our auditor going through each room in the facility to gather the information on the lighting. The next step will be to design a proposal that details the costs, electrical savings, ROI and financing methods for the project. During project execution, we will perform the install with one of our subcontractor labor partners and we will manage the project until the end. We have project management staff on staff that will oversee the project from beginning to end. Aquila will also manage all warranty aspects after the project is completed. The main benefit of our projects is the energy savings being produced and the ability to finance.
	<i>Please outline any other services you provide, such as energy management, design, financial services, other products etc.</i>	We offer the ability to finance the projects through our municipal financing partner which is Government Capital. This allows the customer to finance a project typically within 5 years with a positive savings split that results in \$0 up-front cost for the customer.
	<i>States Covered - Respondent must indicate any and all states or geographies where products and services are being offered. If your services are limited to a certain area, please be specific on the area your services are provided.</i>	Texas and the Southwest
	<i>List the number and location of offices, or service centers for all states being proposed in solicitation</i>	We have one office in Fort Worth, Texas.
History of meeting the delivery, installation, and maintenance timelines	<i>Outline the typical installation and startup process, anticipated timelines and any ongoing maintenance that may be required.</i>	The project will begin with an onsite kickoff meeting which will allow for Aquila to receive keys to the facility and also to stage all product on-site in our storage container. The project management staff will be performing weekly site visits to check quality and address any issues. The project will finalize with a punch walk to cure any defects. The project will typically take anywhere from 2 weeks to 3 months depending on the size of the project.
Response to emergency orders and maintenance repair/requests	<i>Describe the type of emergency orders or requests your organization typically receives and how you respond to those requests</i>	We do not typically receive any emergency orders as our projects are turnkey lighting projects, we do not offer any other services. The nature of our projects are not emergency in nature.
Ability to meet the warranty needs of members	<i>Describe the warranty, including equipment, parts, labor, software, hardware and any other</i>	Our projects will have a one year workmanship warranty that will cover any labor defects. The LED product will have a warranty that ranges from 5 years to 10 years depending on the type of product. Aquila will

	<i>service or equipment that would require a warranty. Include how you support the warranty.</i>	manage the entire warranty process for our customers and deal directly with the manufacturer on behalf of the customer.
Return and restocking policy and applicable fees	<i>Please describe your company's return and restocking policy, including any commitments necessary for services and fees for agencies to end services early.</i>	We do not have a policy for returns/restocking as our service is a turnkey LED retrofit.
Customer service/problem resolution	<i>Describe your company's Customer Service Department (hours of operation, how you resolve issues, number of service centers, etc.).</i>	Our project management staff is available during business hours and after hours to help address any issues during installation or post-project management.
Financial condition of vendor	<i>Demonstrate your financial strength and stability with meaningful data. This could include, but is not limited to, such items as financial statements, SEC filings, credit &amp; bond ratings, letters of credit, and detailed reference letters</i>	Aquila Environmental has a bonding capacity of \$2 Million. This bonding document is included in our response to this RFP.
	<i>What was your annual sales volume over last three (3) years?</i>	We have averaged 10 school districts per year.
Capabilities related to ordering, returns, reporting, and overall website ease-of-use	<i>Provide relevant information regarding your ordering process and overall implementation.</i>	Due to our service being a turnkey service, there is not an ordering service.
Training & Implementation	<i>Describe training or support you provide to help agencies understand how to utilize the spaces and technology equipment being installed.</i>	Our project management staff will be on-site weekly to address any issues and to train the customer to properly manage the new LED lighting system. Typically, the amount of training needed is very minimal as the LED lighting will just replace the existing lighting.
Security protocols	<i>Describe security protocols in place, including cybersecurity and the safe transmission of data</i>	This does not apply to our services.
Integration with other platforms	<i>Describe any integrations your organization can provide with other platforms or systems.</i>	This does not apply to our services.
Other factors relevant to this section as submitted by the Respondent	<i>Describe the capacity of your company to provide management reports, i.e. consolidated billing by location, time and attendance reports, etc. for each eligible agency</i>	Due to our services being turnkey in nature, our projects are a one-time contract and do not have any recurring billing.
	<i>Provide your safety record, safety rating, EMR and worker's compensation rate where available.</i>	We have had zero insurance claims with our commercial insurance carrier and zero worker compensation claims. We can provide these records if requested.
<b>Qualification and Experience (25 Points)</b>		
Respondent reputation in the marketplace	<i>Provide a link to your company's website</i>	<a href="http://www.Aquilaenv.com">www.Aquilaenv.com</a>
	<i>Please provide a brief history of your company, including the year it was established.</i>	To lead in by highlighting our history; Aquila is based in Fort Worth, Texas and is the new creation of a formerly acquired LED lighting business ("Oldco") that was originally founded in 2005. Oldco was an early mover in the LED retrofit space having converted properties such as the Four Seasons Las Colinas in 2012 and the Gaylord Texan Resort in 2010, until it was acquired by our current ownership in the beginning of 2015. Upon being acquired and substantially recapitalized by current ownership, this led to Aquila being a



		pioneer in the Lighting as a Service (“Laas”) sector, whereas Aquila could internally finance LED retrofits on behalf of its customers. More particularly, Aquila could execute projects without customers having to tender \$1 up front, use the energy savings to pay for the project, and in all cases share in the energy savings.
Past relationship with Region 10 ESC and/or Region 10 ESC members	<i>Have you worked with Region 10 in the past? If so, what was the timeframe for that work?</i>	No.
Experience and qualification of key employees	<i>Please provide contact information and resumes for the person(s) who will be responsible for the following areas. Region 10 requests contacts to cover the following:</i> <ul style="list-style-type: none"> <li>* Executive Support</li> <li>* Account Manager</li> <li>* Contract Manager</li> <li>* Marketing</li> <li>* Billing, reporting &amp; Accounts Payable</li> </ul>	Executive Support: James Coston, C.E.M., VP, <a href="mailto:james@aquilaenv.com">james@aquilaenv.com</a> Account/Contract Manager: Chandan Prasai, Director of Project Engineering, <a href="mailto:chandan@aquilaenv.com">chandan@aquilaenv.com</a> Marketing/Sales: Alan Johnston, VP, <a href="mailto:alan@aquilaenv.com">alan@aquilaenv.com</a> Billing/AP: Kerry Byrd, Controller, <a href="mailto:kerry@aquilaenv.com">kerry@aquilaenv.com</a>
Past experience working with the public sector	<i>What are your overall public sector sales, excluding Federal Government, for last three (3) years?</i>	30 school districts in the state of Texas and 2 out of state.
	<i>What is your strategy to increase market share in the public sector?</i>	Our business is based upon references and word of mouth. We will continue to execute excellent projects and expand our base of relationships.
Past litigation, bankruptcy, reorganization, state investigations of entity or current officers and directors	<i>Provide information regarding whether your firm, either presently or in the past, has been involved in any litigation, bankruptcy, or reorganization.</i>	Aquila has not been involved in any litigation, bankruptcy, or reorganization in the past or present.
Minimum of 5 public sector customer references relating to the products and services within this RFP	<i>Provide a minimum of five (5) customer references for product and/or services of similar scope dating within the past 3 years. Please try to provide references for K12, Higher Education, City/County and State entities. Provide the entity; contact name &amp; title; city &amp; state; phone number; years serviced; description of services; and annual volume</i>	All of our references are for turnkey LED retrofits.  Lance Rainey Chief Financial Officer Melissa ISD Region 10 W: 972-369-6385 lrailey@melissaisd.org  Bryan Ritchey Director of Operations Seminole ISD Region 17 W: 432-758-3662 britchey@seminoleisd.net  Frank Molinar Superintendent White Settlement ISD Region 11  Jay Lashaway Chief Financial Officer jlashaway@seminoleisd.net  David Bitters Assistant Superintendent of Finance & Operations dbitters@wsisd.net

		<p>W: 817-367-1300 fmolinar@wsisd.net</p> <p>Dr. Rich Dear Superintendent Godley ISD Region 11 W: 817-389-2536 <a href="mailto:cdear@godleyisd.net">cdear@godleyisd.net</a></p> <p>Lance Terrell Ex-Chief Financial Officer Levelland ISD Region 17 C: 806-367-0085</p> <p>Bryan Myres Executive Director - Finance <a href="mailto:bmyres@godleyisd.net">bmyres@godleyisd.net</a> 817-592-4161</p>
Certifications in the Industry	<p><i>Provide a copy of all current licenses, registrations and certifications issued by federal, state and local agencies, and any other licenses, registrations or certifications from any other governmental entity with jurisdiction, allowing Respondent to perform the covered services including, but not limited to licenses, registrations or certifications. M/WBE, HUB, DVBE, small and disadvantaged business certifications and other diverse business certifications, as well as manufacturer certifications for sales and service must be included if applicable</i></p>	<p>We have provided our certificate of insurance and our electrical license in Section 3 below.</p>
Company profile and capabilities	<p><i>What best describes your position in the distribution channel? (Manufacturer, Authorized Distributor, Value-Add Reseller, Other</i></p>	<p>We are a Lighting as a Service Company that provides a turnkey LED retrofit project. We are essentially a service provider in this space as we are procuring all necessary aspects of the project directly for the customer.</p>
Other factors relevant to this section as submitted by the Respondent	<p><i>If your company is a privately held organization, please indicate if the company is owned or operated by anyone who has been convicted of a felony. If yes, a detailed explanation of the names and conviction is required.</i></p>	<p>Aquila is not operated or owned by a felon.</p>
		<p>Provide a copy of all current licenses, registrations and certifications issued by federal, state and local agencies, and any other licenses, registrations or certifications from any other governmental entity with jurisdiction, allowing Respondent to perform the covered services. These will be provided in the space provided in Form 6. No answer is required here.</p>
<p><b>MWBE Status and/or Program Capabilities (10 Points)</b></p>		



MWBE status, subcontractor plan, and/or joint venture program	<i>Please indicate whether you hold any diversity certifications, including, but not limited to MWBE, SBE, DBE, DVBE, HUB, or HUBZone</i>	N/A
	<i>Do you currently have a diversity program in place, such as a Mentor Protégé Program or subcontractor program? If you have a diversity program, please describe it and indicate whether you plan to offer your program or partnership through Equalis Group?</i>	N/A
	Please attach any certifications you have as part of your response to Form 6.	
Good faith efforts to involve MWBE subcontractors in response	<i>Did your company contact MWBEs or minority chambers of commerce by telephone, written correspondence, or trade associations at least one week before the due date of this RFP to provide information relevant to this opportunity and to determine whether any MWBEs were interested in subcontracting and/or joint ventures?</i>	There is not an applicable information in this RFP that would deem us to contact any outside parties.
Demonstrated ongoing MWBE program	<i>Outline your subcontractor strategy and efforts your organization takes to include MWBE subcontractors in future work, including but not limited to efforts to reach out to individual MWBE businesses, minority chambers of commerce, and other minority business and trade associations.</i>	We always make an effort to find any MWBE contractors if we are able to find a suitable contractor for the service.
<b>Commitment to Service Equalis Group Members (10 Points)</b>		
Marketing plan, capability, and commitment	<i>Detail how your organization plans to market and promote this contract upon award, including how this contract will fit into your organization's current go-to-market strategy in the public sector.</i>	Our company will market this contract to all customers as we always inform the customer of which cooperatives, we are members of.
	<i>Detail how your organization will train your sales force and customer service representatives on this contract to ensure that they can competently and consistently present the contract to public agency customers and answer any questions they might have concerning it.</i>	We will fully educate our sales staff through on-site training meetings to fully educate them on the nature of this contract. They will then be able to educate all customers up-front on the details of this contract.
	<i>Acknowledge that your organization agrees to provide its company logo(s) to Region 10 ESC and Equalis Group and agrees to provide permission for reproduction of such logo in marketing communications and promotions</i>	We agree to provide our logo to Region 10 ESC and Equalis Group.

Ability to manage a cooperative contract	<i>Describe the capacity of your company to report monthly sales through this agreement to Equalis Group.</i>	We are able to report monthly sales through this agreement as we have a dedicated accounting staff.
	<i>Identify any contracts with other cooperative or government group purchasing organizations of which your company is currently a part of:</i>	We are a part of TIPS and TexBuy.
Commitment to supporting agencies to utilize the contract	<i>If awarded a contract, how would you approach agencies in regards to this contract? Please indicate how this would work for both new customers to your organization, as well as existing.</i>	Aquila will always inform our customers which cooperatives we are members of and work with the cooperative that the customer is most comfortable working with.
Other factors relevant to this section as submitted by the Respondent	<i>Provide the number of sales representatives which will work on this contract and where the sales representatives are located.</i>	We have 2 sales representatives that are located in the DFW area.

### **PROPOSAL FORM 3: CERTIFICATIONS AND LICENSES**

Provide a copy of all current licenses, registrations and certifications issued by federal, state and local agencies, and any other licenses, registrations or certifications from any other governmental entity with jurisdiction, allowing Respondent to perform the covered services including, but not limited to licenses, registrations or certifications. M/WBE, HUB, DVBE, small and disadvantaged business certifications and other diverse business certifications, as well as manufacturer certifications for sales and service must be included if applicable.

*Rick Figueroa*  
Chair

*Thomas F. Butler*  
Vice Chair



*Gerald R. Callas, M.D., F.A.S.A.*  
*Helen Callier*  
*Joel Garza*  
*Gary F. Wesson, D.D.S., M.S.*  
*Nora Castañeda*

## *Electrical Contractor*

**AQUILA ENVIRONMENTAL LLC**

License Number: 33359

The business named above is licensed by the Texas Department of Licensing and Regulation

License Expires: MARCH 09 2022

A handwritten signature in black ink that reads "Brian E. Francis".

Brian E. Francis  
Executive Director

lic-037.dff



**All American Insurance Associates**  
**Managing Risk & Protecting**  
**Assets Since 1973**

January 20, 2022

Re: Aquila Environmental LLC

To Whom It May Concern,

Insurors Indemnity Company is the current bonding company for the above contractor and is working with our insured to provide for their bonding needs. The insurance company would favorably consider any request provided they have met all underwriting conditions at the time of the request and they are presented with an acceptable contract. We consider Aquila Environmental LLC to be an excellent contractor and would recommend them highly for your project. This contractor currently has a 2M aggregate bonding program in force that can be adjusted upward depending on the project size.

Any arrangement for bonds required by a contract are a matter between the principal and the surety and we assume no liability to you or third parties, if for any reason we do not execute said bonds or if circumstances change after the date of this letter. Insurors Indemnity Company is currently rated A- (Excellent) by AM Best Company and is on the US Department of Treasury's list of approved sureties for federal work (T-List). They are domiciled in the State of Texas and licensed with the Texas Department of Insurance to write bonds in the state of Texas.

If you should have any further questions, please do not hesitate to give me a call @ 817-573-2118.

Sincerely,

DocuSigned by:

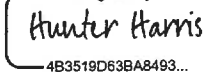

4B3519D63BA8493...

K. Hunter Harris  
Vice President  
All American Insurance Associates





## ADDITIONAL COVERAGES

<b>Ref #</b>	<b>Description</b> PIP-Basic	<b>Coverage Code</b> PIP	<b>Form No.</b>	<b>Edition Date</b>	
<b>Limit 1</b> 2,500	<b>Limit 2</b>	<b>Limit 3</b>	<b>Deductible Amount</b>	<b>Deductible Type</b>	<b>Premium</b>
<b>Ref #</b>	<b>Description</b> Products/Completed Ops Aggregate	<b>Coverage Code</b> PRDCO	<b>Form No.</b>	<b>Edition Date</b>	
<b>Limit 1</b> 2,000,000	<b>Limit 2</b>	<b>Limit 3</b>	<b>Deductible Amount</b>	<b>Deductible Type</b>	<b>Premium</b>
<b>Ref #</b>	<b>Description</b> Umbrella(C)	<b>Coverage Code</b> CUMBR	<b>Form No.</b>	<b>Edition Date</b>	
<b>Limit 1</b>	<b>Limit 2</b>	<b>Limit 3</b>	<b>Deductible Amount</b>	<b>Deductible Type</b>	<b>Premium</b>
<b>Ref #</b>	<b>Description</b>	<b>Coverage Code</b>	<b>Form No.</b>	<b>Edition Date</b>	
<b>Limit 1</b>	<b>Limit 2</b>	<b>Limit 3</b>	<b>Deductible Amount</b>	<b>Deductible Type</b>	<b>Premium</b>
<b>Ref #</b>	<b>Description</b>	<b>Coverage Code</b>	<b>Form No.</b>	<b>Edition Date</b>	
<b>Limit 1</b>	<b>Limit 2</b>	<b>Limit 3</b>	<b>Deductible Amount</b>	<b>Deductible Type</b>	<b>Premium</b>
<b>Ref #</b>	<b>Description</b>	<b>Coverage Code</b>	<b>Form No.</b>	<b>Edition Date</b>	
<b>Limit 1</b>	<b>Limit 2</b>	<b>Limit 3</b>	<b>Deductible Amount</b>	<b>Deductible Type</b>	<b>Premium</b>
<b>Ref #</b>	<b>Description</b>	<b>Coverage Code</b>	<b>Form No.</b>	<b>Edition Date</b>	
<b>Limit 1</b>	<b>Limit 2</b>	<b>Limit 3</b>	<b>Deductible Amount</b>	<b>Deductible Type</b>	<b>Premium</b>
<b>Ref #</b>	<b>Description</b>	<b>Coverage Code</b>	<b>Form No.</b>	<b>Edition Date</b>	
<b>Limit 1</b>	<b>Limit 2</b>	<b>Limit 3</b>	<b>Deductible Amount</b>	<b>Deductible Type</b>	<b>Premium</b>
<b>Ref #</b>	<b>Description</b>	<b>Coverage Code</b>	<b>Form No.</b>	<b>Edition Date</b>	
<b>Limit 1</b>	<b>Limit 2</b>	<b>Limit 3</b>	<b>Deductible Amount</b>	<b>Deductible Type</b>	<b>Premium</b>
<b>Ref #</b>	<b>Description</b>	<b>Coverage Code</b>	<b>Form No.</b>	<b>Edition Date</b>	
<b>Limit 1</b>	<b>Limit 2</b>	<b>Limit 3</b>	<b>Deductible Amount</b>	<b>Deductible Type</b>	<b>Premium</b>
<b>Ref #</b>	<b>Description</b>	<b>Coverage Code</b>	<b>Form No.</b>	<b>Edition Date</b>	
<b>Limit 1</b>	<b>Limit 2</b>	<b>Limit 3</b>	<b>Deductible Amount</b>	<b>Deductible Type</b>	<b>Premium</b>

**PROPOSAL FORM 4: CLEAN AIR WATER ACT**

I, the Vendor, am in compliance with all applicable standards, orders or regulations issued pursuant to the Clean Air Act of 1970, as Amended (42 U.S. C. 1857 (h), Section 508 of the Clean Water Act, as amended (33 U.S.C. 1368), Executive Order 117389 and Environmental Protection Agency Regulation, 40 CFR Part 15 as required under OMB Circular A-102, Attachment O, Paragraph 14 (1) regarding reporting violations to the grantor agency and to the United States Environment Protection Agency Assistant Administrator for the Enforcement.

Potential Vendor: Aguila Environmental

Title of Authorized Representative: James Coston, VP

Mailing Address: 509 Pecan, Ste 200, Ft Worth TX 76102

Signature: 

**PROPOSAL FORM 5: DEBARMENT NOTICE**

I, the Vendor, certify that my company has not been debarred, suspended or otherwise ineligible for participation in Federal Assistance programs under Executive Order 12549, "Debarment and Suspension", as described in the Federal Register and Rules and Regulations.

Potential Vendor: Aquila Environmental

Title of Authorized Representative: James Costen, VP

Mailing Address: 509 Pecan, ste 200, Ft Worth TX 76102

Signature:  \_\_\_\_\_

**PROPOSAL FORM 6: LOBBYING CERTIFICATION**

Submission of this certification is a prerequisite for making or entering into this transaction and is imposed by Section 1352, Title 31, U.S. Code. This certification is a material representation of fact upon which reliance was placed when this transaction was made or entered into. Any person who fails to file the required certification shall be subject to civil penalty of not less than \$10,000 and not more than \$100,000 for each such failure.

The undersigned certifies, to the best of his/her knowledge and belief, that:

1. No Federal appropriated funds have been paid or will be paid on behalf of the undersigned, to any person for influencing or attempting to influence an officer or employee of any agency, a Member of Congress, an officer or employee of Congress, or an employee of a Member of Congress in connection with the awarding of a Federal contract, the making of a Federal grant, the making of a Federal loan, the entering into a cooperative agreement, and the extension, continuation, renewal, amendment, or modification of a Federal contract, grant, loan, or cooperative agreement.
2. If any funds other than Federal appropriated funds have been or will be paid to any person for influencing or attempting to influence an officer or employee of any agency, a Member of Congress, an officer or employee of Congress, or an employee of a Member of Congress in connection with this Federal contract or cooperative agreement, the undersigned shall complete and submit Standard Form LLL, "Disclosure of Lobbying Activities," in accordance with its instructions.
3. The undersigned shall require that the language of this certification be included in the award documents for all covered sub-awards exceeding \$100,000 in Federal funds at all appropriate tiers and that all sub-recipients shall certify and disclose accordingly.

  
\_\_\_\_\_  
Signature of Respondent

  
\_\_\_\_\_  
Date

**PROPOSAL FORM 7: CONTRACTOR CERTIFICATION REQUIREMENTS**

**Contractor’s Employment Eligibility**

By entering the contract, Contractor warrants compliance with the Federal Immigration and Nationality Act (FINA), and all other federal and state immigration laws and regulations. The Contractor further warrants that it is in compliance with the various state statutes of the states it will operate this contract in.

Participating Government Entities including School Districts may request verification of compliance from any Contractor or subcontractor performing work under this Contract. These Entities reserve the right to confirm compliance in accordance with applicable laws.

Should the Participating Entities suspect or find that the Contractor or any of its subcontractors are not in compliance, they may pursue any and all remedies allowed by law, including, but not limited to: suspension of work, termination of the Contract for default, and suspension and/or debarment of the Contractor. All costs necessary to verify compliance are the responsibility of the Contractor.

The Respondent complies and maintains compliance with the appropriate statutes which requires compliance with federal immigration laws by State employers, State contractors and State subcontractors in accordance with the E-Verify Employee Eligibility Verification Program.

Contractor shall comply with governing board policy of the Region 10 ESC Participating entities in which work is being performed.

---

**Fingerprint & Criminal Background Checks**

If required to provide services on school district property at least five (5) times during a month, contractor shall submit a full set of fingerprints to the school district if requested of each person or employee who may provide such service. Alternately, the school district may fingerprint those persons or employees. An exception to this requirement may be made as authorized in Governing Board policy. The district shall conduct a fingerprint check in accordance with the appropriate state and federal laws of all contractors, subcontractors or vendors and their employees for which fingerprints are submitted to the district. Contractor, subcontractors, vendors and their employees shall not provide services on school district properties until authorized by the District.

The Respondent shall comply with fingerprinting requirements in accordance with appropriate statutes in the state in which the work is being performed unless otherwise exempted.

Contractor shall comply with governing board policy in the school district or Participating Entity in which work is being performed.

  
\_\_\_\_\_  
Signature of Respondent

2/22/22  
\_\_\_\_\_  
Date



**PROPOSAL FORM 8: ANTITRUST CERTIFICATION STATEMENTS**  
**(Tex. Government Code § 2155.005)**

I affirm under penalty of perjury of the laws of the State of Texas that:

- (1) I am duly authorized to execute this contract on my own behalf or on behalf of the company, corporation, firm, partnership or individual (Company) listed below;
- (2) In connection with this proposal, neither I nor any representative of the Company has violated any provision of the Texas Free Enterprise and Antitrust Act, Tex. Bus. & Comm. Code Chapter 15;
- (3) In connection with this proposal, neither I nor any representative of the Company has violated any federal antitrust law; and
- (4) Neither I nor any representative of the Company has directly or indirectly communicated any of the contents of this proposal to a competitor of the Company or any other company, corporation, firm, partnership or individual engaged in the same line of business as the Company.

**VENDOR** Aquila Environmental

**ADDRESS** 509 Pecan St. Ste 200  
Ft Worth TX 76102

**PHONE** 817-953-3171

**FAX** N/A

**RESPONDANT**

[Signature]  
Signature

James Coston  
Printed Name

VP  
Position with Company

**AUTHORIZING OFFICIAL**

[Signature]  
Signature

James Coston  
Printed Name

VP  
Position with Company

## PROPOSAL FORM 9: IMPLEMENTATION OF HOUSE BILL 1295

### **Certificate of Interested Parties (Form 1295):**

In 2015, the Texas Legislature adopted House Bill 1295, which added section 2252.908 of the Government Code. The law states that a governmental entity or state agency may not enter into certain contracts with a business entity unless the business entity submits a disclosure of interested parties to the governmental entity or state agency at the time the business entity submits the signed contract to the governmental entity or state agency. The law applies only to a contract of a governmental entity or state agency that either (1) requires an action or vote by the governing body of the entity or agency before the contract may be signed or (2) has a value of at least \$1 million. The disclosure requirement applies to a contract entered into on or after January 1, 2016.

The Texas Ethics Commission was required to adopt rules necessary to implement that law, prescribe the disclosure of interested parties form, and post a copy of the form on the commission's website. The commission adopted the Certificate of Interested Parties form (Form 1295) on October 5, 2015. The commission also adopted new rules (Chapter 46) on November 30, 2015, to implement the law. The commission does not have any additional authority to enforce or interpret House Bill 1295.

### **Filing Process:**

Starting on January 1, 2016, the commission will make available on its website a new filing application that must be used to file Form 1295. A business entity must use the application to enter the required information on Form 1295 and print a copy of the completed form, which will include a certification of filing that will contain a unique certification number. An authorized agent of the business entity must sign the printed copy of the form and have the form notarized. The completed Form 1295 with the certification of filing must be filed with the governmental body or state agency with which the business entity is entering into the contract.

The governmental entity or state agency must notify the commission, using the commission's filing application, of the receipt of the filed Form 1295 with the certification of filing not later than the 30th day after the date the contract binds all parties to the contract. The commission will post the completed Form 1295 to its website within seven business days after receiving notice from the governmental entity or state agency.

Information regarding how to use the filing application will be available on this site starting on January 1, 2016.  
[https://www.ethics.state.tx.us/whatsnew/elf\\_info\\_form1295.htm](https://www.ethics.state.tx.us/whatsnew/elf_info_form1295.htm)

JC

**PROPOSAL FORM 10: BOYCOTT CERTIFICATION AND TERRORIST STATE CERTIFICATION**

**BOYCOTT CERTIFICATION**

Respondents must certify that during the term of any Agreement, it does not boycott Israel and will not boycott Israel. "Boycott" means refusing to deal with, terminating business activities with, or otherwise taking any action that is intended to penalize, inflict economic harm on, or limit commercial relations specifically with Israel, or with a person or entity doing business in Israel or in an Israeli-controlled territory, but does not include an action made for ordinary business purposes.

Does vendor agree?     JC      
(Initials of Authorized Representative)

**TERRORIST STATE CERTIFICATION**

In accordance with Texas Government Code, Chapter 2252, Subchapter F, REGION 10 ESC is prohibited from entering into a contract with a company that is identified on a list prepared and maintained by the Texas Comptroller or the State Pension Review Board under Texas Government Code Sections 806.051, 807.051, or 2252.153. By execution of any agreement, the respondent certifies to REGION 10 ESC that it is not a listed company under any of those Texas Government Code provisions. Responders must voluntarily and knowingly acknowledge and agree that any agreement shall be null and void should facts arise leading the REGION 10 ESC to believe that the respondent was a listed company at the time of this procurement.

Does vendor agree?     JC      
(Initials of Authorized Representative)



## PROPOSAL FORM 12: FEDERAL FUNDS CERIFICATION FORM

When a participating agency seeks to procure goods and services using funds under a federal grant or contract, specific federal laws, regulations, and requirements may apply in addition to those under state law. This includes, but is not limited to, the procurement standards of the Uniform Administrative Requirements, Cost Principles and Audit Requirements for Federal Awards, 2 CFR 200 (sometimes referred to as the "Uniform Guidance" or "EDGAR" requirements). All Vendors submitting proposals must complete this Federal Funds Certification Form regarding Vendor's willingness and ability to comply with certain requirements which may be applicable to specific participating agency purchases using federal grant funds. This completed form will be made available to participating agencies for their use while considering their purchasing options when using federal grant funds. Participating agencies may also require Vendors to enter into ancillary agreements, in addition to the contract's general terms and conditions, to address the member's specific contractual needs, including contract requirements for a procurement using federal grants or contracts.

**For each of the items below, Vendor should certify Vendor's agreement and ability to comply, where applicable, by having Vendor's authorized representative complete and initial the applicable lines after each section and sign the acknowledgment at the end of this form.** If a vendor fails to complete any item in this form, Region 10 ESC will consider the Vendor's response to be that they are unable or unwilling to comply. A negative response to any of the items may, if applicable, impact the ability of a participating agency to purchase from the Vendor using federal funds.

### 1. Vendor Violation or Breach of Contract Terms:

Contracts for more than the simplified acquisition threshold currently set at \$150,000, which is the inflation adjusted amount determined by the Civilian Agency Acquisition Council and the Defense Acquisition Regulations Council (Councils) as authorized by 41 USC 1908, must address administrative, contractual, or legal remedies in instances where contractors violate or breach contract terms, and provide for such sanctions and penalties as appropriate.

Any Contract award will be subject to Region 10 ESC General Terms and Conditions, as well as any additional terms and conditions in any Purchase Order, participating agency ancillary contract, or Member Construction Contract agreed upon by Vendor and the participating agency which must be consistent with and protect the participating agency at least to the same extent as the Region 10 ESC Terms and Conditions.

The remedies under the Contract are in addition to any other remedies that may be available under law or in equity. By submitting a Proposal, you agree to these Vendor violation and breach of contract terms.

Does vendor agree?     JC    

(Initials of Authorized Representative)

### 2. Termination for Cause or Convenience:

When a participating agency expends federal funds, the participating agency reserves the right to immediately terminate any agreement in excess of \$10,000 resulting from this procurement process in the event of a breach or default of the agreement by Offeror in the event Offeror fails to: (1) meet schedules, deadlines, and/or delivery dates within the time specified in the procurement solicitation, contract, and/or a purchase order; (2) make any payments owed; or (3) otherwise perform in accordance with the contract and/or the procurement solicitation. participating agency also reserves the right to terminate the contract immediately, with written notice to offeror, for convenience, if participating agency believes, in its sole discretion that it is in the best

interest of participating agency to do so. Offeror will be compensated for work performed and accepted and goods accepted by participating agency as of the termination date if the contract is terminated for convenience of participating agency. Any award under this procurement process is not exclusive and participating agency reserves the right to purchase goods and services from other offerors when it is in participating agency's best interest.

Does vendor agree?     JC    

(Initials of Authorized Representative)

**3. Equal Employment Opportunity:**

Except as otherwise provided under 41 CFR Part 60, all participating agency purchases or contracts that meet the definition of "federally assisted construction contract" in 41 CFR Part 60-1.3 shall be deemed to include the equal opportunity clause provided under 41 CFR 60-1.4(b), in accordance with Executive Order 11246, "Equal Employment Opportunity" (30 FR 12319, 12935, 3 CFR Part, 1964-1965 Comp., p. 339), as amended by Executive Order 11375, "Amending Executive Order 11246 Relating to Equal Employment Opportunity," and implementing regulations at 41 CFR Part 60, "Office of Federal Contract Compliance Programs, Equal Employment Opportunity, Department of Labor."

The equal opportunity clause provided under 41 CFR 60-1.4(b) is hereby incorporated by reference. Vendor agrees that such provision applies to any participating agency purchase or contract that meets the definition of "federally assisted construction contract" in 41 CFR Part 60-1.3 and Vendor agrees that it shall comply with such provision.

Does vendor agree?     JC    

(Initials of Authorized Representative)

**4. Davis-Bacon Act:**

When required by Federal program legislation, Vendor agrees that, for all participating agency prime construction contracts/purchases in excess of \$2,000, Vendor shall comply with the Davis-Bacon Act (40 USC 3141-3144, and 3146-3148) as supplemented by Department of Labor regulations (29 CFR Part 5, "Labor Standards Provisions Applicable to Contracts Covering Federally Financed and Assisted Construction"). In accordance with the statute, Vendor is required to pay wages to laborers and mechanics at a rate not less than the prevailing wages specified in a wage determination made by the Secretary of Labor. In addition, Vendor shall pay wages not less than once a week.

Current prevailing wage determinations issued by the Department of Labor are available at [www.wdol.gov](http://www.wdol.gov). Vendor agrees that, for any purchase to which this requirement applies, the award of the purchase to the Vendor is conditioned upon Vendor's acceptance of the wage determination.

Vendor further agrees that it shall also comply with the Copeland "Anti-Kickback" Act (40 USC 3145), as supplemented by Department of Labor regulations (29 CFR Part 3, "Contractors and Subcontractors on Public Building or Public Work Financed in Whole or in Part by Loans or Grants from the United States"). The Act provides that each contractor or subrecipient must be prohibited from inducing, by any means, any person employed in the construction, completion, or repair of public work, to give up any part of the compensation to which he or she is otherwise entitled.



Does vendor agree?     JC    

(Initials of Authorized Representative)

**5. Contract Work Hours and Safety Standards Act:**

Where applicable, for all participating agency contracts or purchases in excess of \$100,000 that involve the employment of mechanics or laborers, Vendor agrees to comply with 40 USC 3702 and 3704, as supplemented by Department of Labor regulations (29 CFR Part 5). Under 40 USC 3702 of the Act, Vendor is required to compute the wages of every mechanic and laborer on the basis of a standard work week of 40 hours. Work in excess of the standard work week is permissible provided that the worker is compensated at a rate of not less than one and a half times the basic rate of pay for all hours worked in excess of 40 hours in the work week. The requirements of 40 USC 3704 are applicable to construction work and provide that no laborer or mechanic must be required to work in surroundings or under working conditions which are unsanitary, hazardous or dangerous. These requirements do not apply to the purchases of supplies or materials or articles ordinarily available on the open market, or contracts for transportation or transmission of intelligence.

Does vendor agree?     JC    

(Initials of Authorized Representative)

**6. Right to Inventions Made Under a Contract or Agreement:**

If the participating agency's Federal award meets the definition of "funding agreement" under 37 CFR 401.2(a) and the recipient or subrecipient wishes to enter into a contract with a small business firm or nonprofit organization regarding the substitution of parties, assignment or performance or experimental, developmental, or research work under that "funding agreement," the recipient or subrecipient must comply with the requirements of 37 CFR Part 401, "Rights to Inventions Made by Nonprofit Organizations and Small Business Firms Under Government Grants, Contracts and Cooperative Agreements," and any implementing regulations issued by the awarding agency.

Vendor agrees to comply with the above requirements when applicable.

Does vendor agree?     JC    

(Initials of Authorized Representative)

**7. Clean Air Act and Federal Water Pollution Control Act:**

Clean Air Act (42 USC 7401-7671q.) and the Federal Water Pollution Control Act (33 USC 1251-1387), as amended –Contracts and subgrants of amounts in excess of \$150,000 must contain a provision that requires the non-Federal award to agree to comply with all applicable standards, orders, or regulations issued pursuant to the Clean Air Act (42 USC 7401-7671q.) and the Federal Water Pollution Control Act, as amended (33 USC 1251-1387). Violations must be reported to the Federal awarding agency and the Regional Office of the Environmental Protection Agency (EPA).

When required, Vendor agrees to comply with all applicable standards, orders, or regulations issued pursuant to the Clean Air Act and the Federal Water Pollution Control Act.

Does vendor agree?     JC

(Initials of Authorized Representative)

**8. Debarment and Suspension:**

Debarment and Suspension (Executive Orders 12549 and 12689) – A contract award (see 2 CFR 180.220) must not be made to parties listed on the government-wide exclusions in the System for Award Management (SAM), in accordance with the OMB guidelines at 2 CFR 180 that implement Executive Orders 12549 (3 CFR Part 1966 Comp. p. 189) and 12689 (3CFR Part 1989 Comp. p. 235), “Debarment and Suspension.” SAM Exclusions contains the names of parties debarred, suspended, or otherwise excluded by agencies, as well as parties declared ineligible under statutory or regulatory authority other than Executive Order 12549.

Vendor certifies that Vendor is not currently listed on the government-wide exclusions in SAM, is not debarred, suspended, or otherwise excluded by agencies or declared ineligible under statutory or regulatory authority other than Executive Order 12549. Vendor further agrees to immediately notify the Cooperative and all participating agencies with pending purchases or seeking to purchase from Vendor if Vendor is later listed on the government-wide exclusions in SAM, or is debarred, suspended, or otherwise excluded by agencies or declared ineligible under statutory or regulatory authority other than Executive Order 12549.

Does vendor agree?     Jc    

(Initials of Authorized Representative)

**9. Byrd Anti-Lobbying Amendment:**

Byrd Anti-Lobbying Amendment (31 USC 1352) -- Vendors that apply or bid for an award exceeding \$100,000 must file the required certification. Each tier certifies to the tier above that it will not and has not used Federal appropriated funds to pay any person or organization for influencing or attempting to influence an officer or employee of any agency, a member of Congress, officer or employee of Congress, or an employee of a member of Congress in connection with obtaining any Federal contract, grant or any other award covered by 31 USC 1352. Each tier must also disclose any lobbying with non-Federal funds that takes place in connection with obtaining any Federal award. Such disclosures are forwarded from tier to tier up to the non-Federal award. As applicable, Vendor agrees to file all certifications and disclosures required by, and otherwise comply with, the Byrd Anti-Lobbying Amendment (31 USC 1352).

Does vendor agree?     Jc    

(Initials of Authorized Representative)

**10. Procurement of Recovered Materials:**

For participating agency purchases utilizing Federal funds, Vendor agrees to comply with Section 6002 of the Solid Waste Disposal Act, as amended by the Resource Conservation and Recovery Act where applicable and provide such information and certifications as a participating agency may require to confirm estimates and otherwise comply. The requirements of Section 6002 include procuring only items designated in guidelines of the Environmental Protection Agency (EPA) at 40 CFR Part 247 that contain the highest percentage of recovered materials practicable, consistent with maintaining a satisfactory level of competition, where the purchase price of the item exceeds \$10,000 or the value of the quantity acquired during the preceding fiscal year exceeded \$10,000; procuring solid waste management services in a manner that maximizes energy and resource recovery,

and establishing an affirmative procurement program for procurement of recovered materials identified in the EPA guidelines.

Does vendor agree?     JC    

(Initials of Authorized Representative)

**11. Profit as a Separate Element of Price:**

For purchases using federal funds in excess of \$150,000, a participating agency may be required to negotiate profit as a separate element of the price. See, 2 CFR 200.323(b). When required by a participating agency, Vendor agrees to provide information and negotiate with the participating agency regarding profit as a separate element of the price for a particular purchase. However, Vendor agrees that the total price, including profit, charged by Vendor to the participating agency shall not exceed the awarded pricing, including any applicable discount, under Vendor's Cooperative Contract.

Does vendor agree?     JC    

(Initials of Authorized Representative)

**12. Prohibition on Certain Telecommunications and Video Surveillance Services or Equipment**

Vendor agrees that recipients and subrecipients are prohibited from obligating or expending loan or grant funds to procure or obtain, extend or renew a contract to procure or obtain, or enter into a contract (or extend or renew a contract) to procure or obtain equipment, services, or systems that uses covered telecommunications equipment or services as a substantial or essential component of any system, or as critical technology as part of any system from companies described in Public Law 115-232, section 889. Telecommunications or video surveillance equipment or services produced or provided by an entity that the Secretary of Defense, in consultation with the Director of the National Intelligence or the Director of the Federal Bureau of Investigation, reasonably believes to be an entity owned or controlled by, or otherwise connected to, the government of a covered foreign country are also prohibited.

Does vendor agree?     JC    

(Initials of Authorized Representative)

**13. General Compliance and Cooperation with Participating Agencies:**

In addition to the foregoing specific requirements, Vendor agrees, in accepting any Purchase Order from a participating agency, it shall make a good faith effort to work with participating agencies to provide such information and to satisfy such requirements as may apply to a particular participating agency purchase or purchases including, but not limited to, applicable recordkeeping and record retention requirements.

Does vendor agree?     JC    

(Initials of Authorized Representative)

**14. Applicability to Subcontractors**

Offeror agrees that all contracts it awards pursuant to the Contract shall be bound by the foregoing terms and conditions.

Does vendor agree?     JC

(Initials of Authorized Representative)

By signature below, I certify that the information in this form is true, complete, and accurate and that I am authorized by my company to make this certification and all consents and agreements contained herein.

Aguila Environmental

Company Name

[Signature]

Signature of Authorized Company Official

James Coston

Printed Name

VP

Title

2/22/22

Date

## **PROPOSAL FORM 13: ADDITIONAL ARIZONA CONTRACTOR REQUIREMENTS**

**AZ Compliance with Federal and state requirements:** Contractor agrees when working on any federally assisted projects with more than \$2,000.00 in labor costs, to comply with all federal and state requirements, as well as Equal Opportunity Employment requirements and all other federal and state laws, statutes, etc. Contractor agrees to post wage rates at the work site and submit a copy of their payroll to the member for their files. Contractor must retain records for three years to allow the federal grantor agency access to these records, upon demand. Contractor also agrees to comply with the Arizona Executive Order 75-5, as amended by Executive Order 99-4.

When working on contracts funded with Federal Grant monies, contractor additionally agrees to comply with the administrative requirements for grants, and cooperative agreements to state, local and federally recognized Indian Tribal Governments.

**AZ Compliance with workforce requirements:** Pursuant to ARS 41-4401, Contractor and subcontractor(s) warrant their compliance with all federal and state immigration laws and regulations that relate to their employees, and compliance with ARS 23-214 subsection A, which states, ..."every employer, after hiring an employee, shall verify the employment eligibility of the employee through the E-Verify program" Region 10 ESC reserves the right to cancel or suspend the use of any contract for violations of immigration laws and regulations. Region 10 ESC and its members reserve the right to inspect the papers of any contractor or subcontract employee who works under this contract to ensure compliance with the warranty above.

**AZ Contractor Employee Work Eligibility:** By entering into this contract, contractor agrees and warrants compliance with A.R.S. 41-4401, A.R.S. 23-214, the Federal Immigration and Nationality Act (FINA), and all other Federal immigration laws and regulations. Region 10 ESC and/or Region 10 ESC members may request verification of compliance from any contractor or sub contractor performing work under this contract. Region 10 ESC and Region 10 ESC members reserve the right to confirm compliance. In the event that Region 10 ESC or Region 10 ESC members suspect or find that any contractor or subcontractor is not in compliance, Region 10 ESC may pursue any and all remedies allowed by law, including but not limited to suspension of work, termination of contract, suspension and/or debarment of the contractor. All cost associated with any legal action will be the responsibility of the contractor.

**AZ Non-Compliance:** All federally assisted contracts to members that exceed \$10,000.00 may be terminated by the federal grantee for noncompliance by contractor. In projects that are not federally funded, Respondent must agree to meet any federal, state or local requirements as necessary. In addition, if compliance with the federal regulations increases the contract costs beyond the agreed on costs in this solicitation, the additional costs may only apply to the portion of the work paid by the federal grantee.

**Registered Sex Offender Restrictions (Arizona):** For work to be performed at an Arizona school, contractor agrees that no employee or employee of a subcontractor who has been adjudicated to be a registered sex offender will perform work at any time when students are present, or reasonably expected to be present. Contractor agrees that a violation of this condition shall be considered a material breach and may result in the cancellation of the purchase order at the Region 10 ESC member's discretion. Contractor must identify any additional costs associated with compliance to this term. If no costs are specified, compliance with this term will be provided at no additional charge.

**Offshore Performance of Work Prohibited:** Due to security and identity protection concerns, direct services under this contract shall be performed within the borders of the United States.

**Terrorism Country Divestments:** In accordance with A.R.S. 35-392, Region 10 ESC and Region 10 ESC members are prohibited from purchasing from a company that is in violation of the Export Administration Act. By entering into the contract, contractor warrants compliance with the Export Administration Act.

The undersigned hereby accepts and agrees to comply with all statutory compliance and notice requirements listed in this document.



Signature of Respondent

2/22/22

Date



**PROPOSAL FORM 14: OWNERSHIP DISCLOSURE FORM (N.J.S. 52:25-24.2)**

Pursuant to the requirements of P.L. 1999, Chapter 440 effective April 17, 2000 (Local Public Contracts Law), the Respondent shall complete the form attached to these specifications listing the persons owning 10 percent (10%) or more of the firm presenting the proposal.

Company Name: Aguila Environmental, LLC  
Street: 509 Pecan St., Suite 200  
City, State, Zip Code: Fort Worth, TX 76102

**Complete as appropriate:**

I John Sledge, certify that I am the sole owner of Aguila Environmental, that there are no partners and the business is not incorporated, and the provisions of N.J.S. 52:25-24.2 do not apply.

**OR:**

I \_\_\_\_\_, a partner in \_\_\_\_\_, do hereby certify that the following is a list of all individual partners who own a 10% or greater interest therein. I further certify that if one (1) or more of the partners is itself a corporation or partnership, there is also set forth the names and addresses of the stockholders holding 10% or more of that corporation's stock or the individual partners owning 10% or greater interest in that partnership.

**OR:**

I \_\_\_\_\_, an authorized representative of \_\_\_\_\_, a corporation, do hereby certify that the following is a list of the names and addresses of all stockholders in the corporation who own 10% or more of its stock of any class. I further certify that if one (1) or more of such stockholders is itself a corporation or partnership, that there is also set forth the names and addresses of the stockholders holding 10% or more of the corporation's stock or the individual partners owning a 10% or greater interest in that partnership.

**(Note: If there are no partners or stockholders owning 10% or more interest, indicate none.)**

Name	Address	Interest

I further certify that the statements and information contained herein, are complete and correct to the best of my knowledge and belief.

  
Authorized Signature and Title

2/22/22  
Date

**PROPOSAL FORM 15: NON-COLLUSION AFFIDAVIT**

Company Name: Aguila Environmental  
Street: 509 Pecan, Ste 200  
City, State, Zip Code: Fort Worth, TX 76179

State of ~~New Jersey~~ Texas

County of Tarrant

I, James Coston of the Fort Worth  
Name City

in the County of Tarrant, State of Texas of full  
age, being duly sworn according to law on my oath depose and say that:

I am the Vice-President of the firm of Aguila Environmental  
Title Company Name

*the Respondent making the Proposal for the goods, services or public work specified under the Harrison Township Board of Education attached proposal, and that I executed the said proposal with full authority to do so; that said Respondent has not directly or indirectly entered into any agreement, participated in any collusion, or otherwise taken any action in restraint of free, competitive bidding in connection with the above proposal, and that all statements contained in said bid proposal and in this affidavit are true and correct, and made with full knowledge that the Harrison Township Board of Education relies upon the truth of the statements contained in said bid proposal and in the statements contained in this affidavit in awarding the contract for the said goods, services or public work.*

*I further warrant that no person or selling agency has been employed or retained to solicit or secure such contract upon an agreement or understanding for a commission, percentage, brokerage or contingent fee, except bona fide employees or bona fide established commercial or selling agencies maintained by*

Aguila Environmental  
Company Name

[Signature] VP  
Authorized Signature & Title

Subscribed and sworn before me

this 22 day of February, 20 22

Kerry Byrd Kerry Byrd  
Notary Public of New Jersey Texas  
My commission expires 5/08/20 22

SEAL

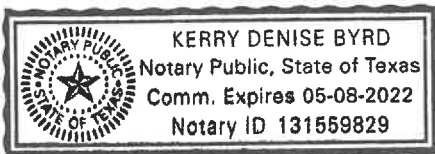

**PROPOSAL FORM 16: AFFIRMATIVE ACTION AFFIDAVIT (P.L. 1975, C.127)**

Company Name: Aquila Environmental  
Street: 509 Pecan, Ste 200  
City, State, Zip Code: Fort Worth TX 76102

**Bid Proposal Certification:**

Indicate below your compliance with New Jersey Affirmative Action regulations. Your proposal will be accepted even if you are not in compliance at this time. No contract and/or purchase order may be issued, however, until all Affirmative Action requirements are met.

**Required Affirmative Action Evidence:**

Procurement, Professional & Service Contracts (Exhibit A)

Vendors must submit with proposal:

- 1. A photo copy of their Federal Letter of Affirmative Action Plan Approval NA (Texas)  
OR
- 2. A photo copy of their Certificate of Employee Information Report \_\_\_\_\_  
OR
- 3. A complete Affirmative Action Employee Information Report (AA302) \_\_\_\_\_

**Public Work – Over \$50,000 Total Project Cost:**

- A. No approved Federal or New Jersey Affirmative Action Plan. We will complete Report Form AA201-A upon receipt from the Harrison Township Board of Education ✓
- B. Approved Federal or New Jersey Plan – certificate enclosed \_\_\_\_\_

I further certify that the statements and information contained herein, are complete and correct to the best of my knowledge and belief.

 VP  
Authorized Signature and Title

2/22/22  
Date

**P.L. 1995, c. 127 (N.J.A.C. 17:27)**  
**MANDATORY AFFIRMATIVE ACTION LANGUAGE**

**PROCUREMENT, PROFESSIONAL AND SERVICE CONTRACTS**

During the performance of this contract, the contractor agrees as follows:

The contractor or subcontractor, where applicable, will not discriminate against any employee or applicant for employment because of age, race, creed, color, national origin, ancestry, marital status, sex, affectional or sexual orientation. The contractor will take affirmative action to ensure that such applicants are recruited and employed, and that employees are treated during employment, without regard to their age, race, creed, color,

national origin, ancestry, marital status, sex, affectional or sexual orientation. Such action shall include, but not be limited to the following: employment, upgrading, demotion, or transfer; recruitment or recruitment advertising; layoff or termination; rates of pay or other forms of compensation; and selection for training, including apprenticeship. The contractor agrees to post in conspicuous places, available to employees and applicants for employment, notices to be provided by the Public Agency Compliance Officer setting forth provisions of this non-discrimination clause.

The contractor or subcontractor, where applicable will, in all solicitations or advertisement for employees placed by or on behalf of the contractor, state that all qualified applicants will receive consideration for employment without regard to age, race, creed, color, national origin, ancestry, marital status, sex, affectional or sexual orientation.

The contractor or subcontractor, where applicable, will send to each labor union or representative of workers with which it has a collective bargaining agreement or other contract or understanding, a notice, to be provided by the agency contracting officer advising the labor union or workers' representative of the contractor's commitments under this act and shall post copies of the notice in conspicuous places available to employees and applicants for employment.

The contractor or subcontractor, where applicable, agrees to comply with any regulations promulgated by the Treasurer pursuant to P.L. 1975, c. 127, as amended and supplemented from time to time and the Americans with Disabilities Act.

The contractor or subcontractor agrees to attempt in good faith to employ minority and female workers trade consistent with the applicable county employment goal prescribed by N.J.A.C. 17:27-5.2 promulgated by the Treasurer pursuant to P.L. 1975, C.127, as amended and supplemented from time to time or in accordance with a binding determination of the applicable county employment goals determined by the Affirmative Action Office pursuant to N.J.A.C. 17:27-5.2 promulgated by the Treasurer pursuant to P.L. 1975, C.127, as amended and supplemented from time to time.

The contractor or subcontractor agrees to inform in writing appropriate recruitment agencies in the area, including employment agencies, placement bureaus, colleges, universities, labor unions, that it does not discriminate on the basis of age, creed, color, national origin, ancestry, marital status, sex, affectional or sexual orientation, and that it will discontinue the use of any recruitment agency which engages in direct or indirect discriminatory practices.

The contractor or subcontractor agrees to revise any of its testing procedures, if necessary, to assure that all personnel testing conforms with the principles of job-related testing, as established by the statutes and court decisions of the state of New Jersey and as established by applicable Federal law and applicable Federal court decisions.

The contractor or subcontractor agrees to review all procedures relating to transfer, upgrading, downgrading and lay-off to ensure that all such actions are taken without regard to age, creed, color, national origin, ancestry, marital status, sex, affectional or sexual orientation, and conform with the applicable employment goals, consistent with the statutes and court decisions of the State of New Jersey, and applicable Federal law and applicable Federal court decisions.

The contractor and its subcontractors shall furnish such reports or other documents to the Affirmative Action Office as may be requested by the office from time to time in order to carry out the purposes of these regulations, and public agencies shall furnish such information as may be requested by the Affirmative Action Office for conducting a compliance investigation pursuant to Subchapter 10 of the Administrative Code (NJAC 17:27).



---

Signature of Procurement Agent

## PROPOSAL FORM 17: C. 271 POLITICAL CONTRIBUTION DISCLOSURE FORM

### Public Agency Instructions

This page provides guidance to public agencies entering into contracts with business entities that are required to file Political Contribution Disclosure forms with the agency. **It is not intended to be provided to contractors.** What follows are instructions on the use of form local units can provide to contractors that are required to disclose political contributions pursuant to N.J.S.A. 19:44A-20.26 (P.L. 2005, c. 271, s.2). Additional information is available in Local Finance Notice 2006-1 ([https://www.nj.gov/dca/divisions/dlgs/resources/lfns\\_2006.html](https://www.nj.gov/dca/divisions/dlgs/resources/lfns_2006.html)).

1. The disclosure is required for all contracts in excess of \$17,500 that are **not awarded** pursuant to a “fair and open” process (N.J.S.A. 19:44A-20.7).
2. Due to the potential length of some contractor submissions, the public agency should consider allowing data to be submitted in electronic form (i.e., spreadsheet, pdf file, etc.). Submissions must be kept with the contract documents or in an appropriate computer file and be available for public access. **The form is worded to accept this alternate submission.** The text should be amended if electronic submission will not be allowed.
3. The submission must be **received from the contractor and** on file at least 10 days prior to award of the contract. Resolutions of award should reflect that the disclosure has been received and is on file.
4. The contractor must disclose contributions made to candidate and party committees covering a wide range of public agencies, including all public agencies that have elected officials in the county of the public agency, state legislative positions, and various state entities. The Division of Local Government Services recommends that contractors be provided a list of the affected agencies. This will assist contractors in determining the campaign and political committees of the officials and candidates affected by the disclosure.
  - a) The Division has prepared model disclosure forms for each county. They can be downloaded from the “County PCD Forms” link on the Pay-to-Play web site at [https://www.state.nj.us/dca/divisions/dlgs/programs/pay\\_2\\_play.html](https://www.state.nj.us/dca/divisions/dlgs/programs/pay_2_play.html) They will be updated from time-to-time as necessary.
  - b) A public agency using these forms **should edit them to properly reflect the correct legislative district(s)**. As the forms are county-based, **they list all legislative districts** in each county. **Districts that do not represent the public agency should be removed from the lists.**
  - c) Some contractors may find it easier to provide a single list that covers all contributions, regardless of the county. These submissions are appropriate and should be accepted.
  - d) The form may be used “as-is”, subject to edits as described herein.
  - e) The “Contractor Instructions” sheet is intended to be provided with the form. It is recommended that the Instructions and the form be printed on the same piece of paper. The form notes that the Instructions are printed on the back of the form; where that is not the case, the text should be edited accordingly.
  - f) The form is a Word document and can be edited to meet local needs, and posted for download on web sites, used as an e-mail attachment, or provided as a printed document.
5. It is recommended that the contractor also complete a “Stockholder Disclosure Certification.” This will assist the local unit in its obligation to ensure that contractor did not make any prohibited contributions to the committees listed on the Business Entity Disclosure Certification in the 12 months prior to the contract. (See Local Finance Notice 2006-7 for additional information on this obligation) A sample Certification form is part of this package and the instruction to complete it is included in the Contractor Instructions. **NOTE: This section is not applicable to Boards of Education.**



## C. 271 POLITICAL CONTRIBUTION DISCLOSURE FORM

### Contractor Instructions

Business entities (contractors) receiving contracts from a public agency that are NOT awarded pursuant to a "fair and open" process (defined at N.J.S.A. 19:44A-20.7) are subject to the provisions of P.L. 2005, c. 271, s.2 (N.J.S.A. 19:44A-20.26). This law provides that 10 days prior to the award of such a contract, the contractor shall disclose contributions to:

1. any State, county, or municipal committee of a political party
2. any legislative leadership committee\*
3. any continuing political committee (a.k.a., political action committee)
4. any candidate committee of a candidate for, or holder of, an elective office:
  1. of the public entity awarding the contract
  2. of that county in which that public entity is located
  3. of another public entity within that county
  4. or of a legislative district in which that public entity is located or, when the public entity is a county, of any legislative district which includes all or part of the county. The disclosure must list reportable contributions to any of the committees that exceed \$300 per election cycle that were made during the 12 months prior to award of the contract. See N.J.S.A. 19:44A-8 and 19:44A-16 for more details on reportable contributions.

N.J.S.A. 19:44A-20.26 itemizes the parties from whom contributions must be disclosed when a business entity is not a natural person. This includes the following:

5. individuals with an "interest" ownership or control of more than 10% of the profits or assets of a business entity or 10% of the stock in the case of a business entity that is a corporation for profit
6. all principals, partners, officers, or directors of the business entity or their spouses
7. any subsidiaries directly or indirectly controlled by the business entity
8. IRS Code Section 527 New Jersey based organizations, directly or indirectly controlled by the business entity and filing as continuing political committees, (PACs). When the business entity is a natural person, "a contribution by that person's spouse or child, residing therewith, shall be deemed to be a contribution by the business entity." [N.J.S.A. 19:44A-20.26(b)] The contributor must be listed on the disclosure. Any business entity that fails to comply with the disclosure provisions shall be subject to a fine imposed by ELEC in an amount to be determined by the Commission which may be based upon the amount that the business entity failed to report. The enclosed list of agencies is provided to assist the contractor in identifying those public agencies whose elected official and/or candidate campaign committees are affected by the disclosure requirement. It is the contractor's responsibility to identify the specific committees to which contributions may have been made and need to be disclosed. The disclosed information may exceed the minimum requirement. The enclosed form, a content-consistent facsimile, or an electronic data file containing the required details (along with a signed cover sheet) may be used as the contractor's submission and is disclosable to the public under the Open Public Records Act. The contractor must also complete the attached Stockholder Disclosure Certification. This will assist the agency in meeting its obligations under the law.

**NOTE: This section does not apply to Board of Education contracts.**

\* N.J.S.A. 19:44A-3(s): "The term "legislative leadership committee" means a committee established, authorized to be established, or designated by the President of the Senate, the Minority Leader of the Senate, the Speaker





**List of Agencies with Elected Officials Required for Political Contribution Disclosure**

**N.J.S.A. 19:44A-20.26**

**County Name:**

State: Governor, and Legislative Leadership Committees

Legislative District #s:

State Senator and two members of the General Assembly per district.

**County:**

Freeholders

County Clerk

Sheriff

{County Executive}

Surrogate

Municipalities (Mayor and members of governing body, regardless of title):

**USERS SHOULD CREATE THEIR OWN FORM, OR DOWNLOAD FROM [WWW.NJ.GOV/DCA/LGS/P2P](http://WWW.NJ.GOV/DCA/LGS/P2P) A COUNTY-BASED, CUSTOMIZABLE FORM.**

**PROPOSAL FORM 18: STOCKHOLDER DISCLOSURE CERTIFICATION**

**Name of Business:**

I certify that the list below contains the names and home addresses of all stockholders holding 10% or more of the issued and outstanding stock of the undersigned.

**OR**

I certify that no one stockholder owns 10% or more of the issued and outstanding stock of the undersigned.

**Check the box that represents the type of business organization:**

Partnership

Sole Proprietorship

Limited Liability Partnership

Corporation

Limited Partnership

Subchapter S Corporation

Limited Liability Corporation

**Sign and notarize the form below, and, if necessary, complete the stockholder list below.**

Stockholders:

Name:	Name:
Home Address:	Home Address:
Name:	Name:
Home Address:	Home Address:
Name:	Name:
Home Address:	Home Address:
Subscribed and sworn before me this <u>22</u> day of <u>February</u> , 2022.	 _____ (Affiant)
(Notary Public) <u>Kerry Byrd Kerry Byrd</u>	<u>James Cotary VP</u> _____ (Print name & title of affiant)
My Commission expires: <u>5/08/2022</u>	(Corporate Seal)

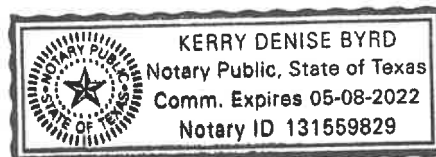

**PROPOSAL FORM 19: GENERAL TERMS AND CONDITIONS ACCEPTANCE FORM**

*Signature on the Vendor Contract Signature form certifies complete acceptance of the General Terms and Conditions in this solicitation, except as noted below (additional pages may be attached, if necessary).*

**Check one of the following responses to the General Terms and Conditions:**

We take no exceptions/deviations to the general terms and conditions

*(Note: If none are listed below, it is understood that no exceptions/deviations are taken.)*

We take the following exceptions/deviations to the general terms and conditions. All exceptions/deviations must be clearly explained. Reference the corresponding general terms and conditions that you are taking exceptions/deviations to. Clearly state if you are adding additions terms and conditions to the general terms and conditions. Provide details on your exceptions/deviations below:

*(Note: Unacceptable exceptions shall remove your proposal from consideration for award. Region 10 ESC shall be the sole judge on the acceptance of exceptions/deviations and the decision shall be final.)*



## PROPOSAL FORM 20: EQUALIS GROUP ADMINISTRATION AGREEMENT

### Requirements for Master Agreement To be administered by Equalis Group

**Attachment A, Equalis Group Administrative Agreement** is used in administering Master Agreements with Region 10 and is preferred by Equalis Group. Redlined copies of this agreement should not be submitted with the response. Should a respondent be recommended for award, this agreement will be negotiated and executed between Equalis Group and the respondent. **Respondents must select one of the following options for submitting their response.**

- Respondent agrees to all terms and conditions outlined in each of the Administration Agreement.
- Respondent wishes to negotiate directly with Equalis Group on terms and conditions outlined in the Administration Agreement. Negotiations will commence after sealed Proposals are opened and Region 10 has determined the respondent met all requirements in their response and may be eligible for award.

**PROPOSAL FORM 21: OPEN RECORDS POLICY ACKNOWLEDGEMENT AND ACCEPTANCE**  
**OPEN RECORDS POLICY ACKNOWLEDGMENT AND ACCEPTANCE**

Be advised that all information and documents submitted will be subject to the Public Information Act requirements governed by Chapter 552 of the Texas Government Code.

Because contracts are awarded by a Texas governmental entity, all responses submitted are subject to release as public information after contracts are executed. If a Respondent believes that its response, or parts of its response, may be exempted from disclosure to the public, the Respondent must specify page-by-page and line-by-line the parts of the response, which it believes, are exempted from disclosure. In addition, the Respondent must specify which exception(s) are applicable and provide detailed reasons to substantiate the exception(s). Respondent must provide this information on the "Acknowledgement and Acceptance to Region 10 ESC's Public Information Act Policy" form found on the next page of this solicitation. Any information that is unmarked will be considered public information and released, if requested under the Public Information Act.

The determination of whether information is confidential and not subject to disclosure is the duty of the Office of Attorney General (OAG). Region 10 ESC must provide the OAG with the information requested in order for the OAG to render an opinion. In such circumstances, Respondent will be notified in writing that the material has been requested and delivered to the OAG. Respondent will have an opportunity to make arguments to the OAG in writing regarding the exception(s) to the TPIA that permit the information to be withheld from public disclosure. Respondents are advised that such arguments to the OAG must be specific and well-reasoned--vague and general claims to confidentiality by the Respondent are generally not acceptable to the OAG. Once the OAG opinion is received by Region 10 ESC, Region 10 ESC must comply with the opinions of the OAG. Region 10 ESC assumes no responsibility for asserting legal arguments on behalf of any Respondent. Respondents are advised to consult with their legal counsel concerning disclosure issues resulting from this procurement process and to take precautions to safeguard trade secrets and other proprietary information.

After completion of award, these documents will be available for public inspection.

**Signature below certifies complete acceptance of Region 10 ESC's Open Records Policy, except as noted below (additional pages may be attached, if necessary). Check one of the following responses to the Acknowledgment and Acceptance of Region 10 ESC's Open Records Policy below:**

We acknowledge Region 10 ESC's Public Information Act policy and declare that no information submitted with this proposal, or any part of our proposal, is exempt from disclosure under the Public Information Act.

*(Note: All information believed to be a trade secret or proprietary must be listed below. It is further understood that failure to identify such information, in strict accordance with the instructions below, will result in that information being considered public information and released, if requested under the Public Information Act.)*

We declare the following information to be a trade secret or proprietary and exempt from disclosure under the Public Information Act.

*(Note: Respondent must specify page-by-page and line-by-line the parts of the response, which it believes, are exempt. In addition, Respondent must specify which exception(s) are applicable and provide detailed reasons to substantiate the exception(s).)*

2/22/22  
Date

  
Authorized Signature & Title VP

**PROPOSAL FORM 22: VENDOR CONTRACT AND SIGNATURE FORM**

The undersigned hereby proposes and agrees to furnish goods and/or services in strict compliance with the terms, specifications and conditions at the prices proposed within response unless noted in writing. The undersigned further certifies that he/she is an officer of the company and has authority to negotiate and bind the company named below and has not prepared this proposal in collusion with any other Respondent and that the contents of this proposal as to prices, terms or conditions of said proposal have not been communicated by the undersigned nor by any employee or agent to any person engaged in this type of business prior to the official opening of this proposal.

**VENDORS MUST SUBMIT THIS FORM COMPLETED AND SIGNED WITH THEIR RESPONSE TO BE CONSIDERED**

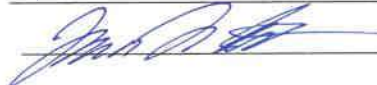
Company name Aquila Environmental  
Address 509 Pecan, Suite 200  
City/State/Zip Fort Worth, TX 76102  
Telephone No. 817-953-3171  
Fax No. NA  
Email address James@aquila.env.com  
Printed name James Coston  
Position with company VP  
Authorized signature 

Term of contract March 1, 2022 to February 28, 2025

Unless otherwise stated, all contracts are for a period of three (3) years with an option to renew annually for an additional two (2) years if agreed to by Region 10 ESC. Vendor shall honor all administrative fees for any sales made based on the contract whether renewed or not.

  
Jana Melsheimer (Apr 20, 2022 10:36 CDT)  
Region 10 ESC Authorized Agent

4/20/22  
Date

Dr. Jana Melsheimer  
Print Name

Equalis Group Contract Number R10-1133A



Did you sign the vendor contract and signature form? **If not, your Proposal will be rejected.**

Region 10 will negotiate any exceptions and both parties will agree upon which exceptions will be accepted or altered before the Region 10 board votes to accept or reject the proposals.