



REQUEST FOR PROPOSALS:

Furniture Solutions with Related Products & Services

RFP #:

COG-2152

ISSUED BY:

The Cooperative Council of Governments

On Behalf of Equalis Group

6001 Cochran Road, Suite 333

Cleveland, Ohio 44139

DATED:

October 13, 2023

SECTION TWO:

Proposal Submission Documents, Technical Proposal, Cost Proposal and Other Required Forms

TABLE OF CONTENTS

PROPOSAL FORM CHECKLIST.....	3
PROPOSAL FORM 1: TECHNICAL PROPOSAL.....	4
PROPOSAL FORM 2: COST PROPOSAL.....	13
PROPOSAL FORM 3: DIVERSITY VENDOR CERTIFICATION PARTICIPATION	14
PROPOSAL FORM 4: CERTIFICATIONS AND LICENSES	15
PROPOSAL FORM 5: UNRESOLVED FINDINGS FOR RECOVERY	16
PROPOSAL FORM 6: MANDATORY DISCLOSURES.....	17
PROPOSAL FORM 7: DEALER, RESELLER, AND DISTRIBUTOR AUTHORIZATION.....	18
PROPOSAL FORM 8: MANDATORY SUPPLIER & PROPOSAL CERTIFICATIONS	19
PROPOSAL FORM 9: CLEAN AIR ACT & CLEAN WATER ACT	20
PROPOSAL FORM 10: DEBARMENT NOTICE.....	21
PROPOSAL FORM 11: LOBBYING CERTIFICATIONS	22
PROPOSAL FORM 12: CONTRACTOR CERTIFICATION REQUIREMENTS.....	23
PROPOSAL FORM 13: BOYCOTT CERTIFICATION	24
PROPOSAL FORM 14: FEDERAL FUNDS CERTIFICATION FORMS	25
PROPOSAL FORM 15: FEMA FUNDING REQUIREMENTS CERTIFICATION FORMS.....	31
PROPOSAL FORM 16: ARIZONA CONTRACTOR REQUIREMENTS	34
PROPOSAL FORM 17: NEW JERSEY REQUIREMENTS.....	36
PROPOSAL FORM 18: GENERAL TERMS AND CONDITIONS ACCEPTANCE FORM.....	47
PROPOSAL FORM 19: EQUALIS GROUP ADMINISTRATION AGREEMENT DECLARATION	48
PROPOSAL FORM 20: MASTER AGREEMENT SIGNATURE FORM.....	49

PROPOSAL FORM CHECKLIST

The following documents must be submitted with the Proposal.

The below documents can be found in Section 2; Proposal Submission and Required Forms and must be submitted with the proposal. Please note Proposal Form 2 is a separate attachment (attachment B).

TECHNICAL PROPOSAL

- Proposal Form 1: Technical Proposal**

PROPOSAL PRICING: Attachment B is provided separately in a Microsoft Excel file and is required to complete your cost proposal.

- Proposal Form 2: Cost Proposal**

OTHER REQUIRED PROPOSAL FORMS:



- Proposal Form 3: Diversity Vendor Certification Participation**
- Proposal Form 4: Certifications and Licenses**
- Proposal Form 5: Unresolved Findings for Recovery**
- Proposal Form 6: Mandatory Disclosures**
- Proposal Form 7: Dealer, Reseller, and Distributor Authorization**
- Proposal Form 8: Mandatory Supplier & Proposal Certifications**
- Proposal Form 9: Clean Air Act & Clean Water Act**
- Proposal Form 10: Debarment Notice**
- Proposal Form 11: Lobbying Certification**
- Proposal Form 12: Contractor Certification Requirements**
- Proposal Form 13: Boycott Certification**
- Proposal Form 14 Federal Funds Certification Forms**
- Proposal Form 15 FEMA Funding Requirements Certification Form**
- Proposal Form 16: Arizona Contractor Requirements**
- Proposal Form 17: New Jersey Requirements**
- Proposal Form 18: General Terms and Conditions Acceptance Form**
- Proposal Form 19: Equalis Group Administration Agreement Declaration**
- Proposal Form 20: Master Agreement Signature Form**

(The rest of this page is intentionally left blank)

PROPOSAL FORM 1: TECHNICAL PROPOSAL

1. <u>OVERVIEW & QUALIFICATIONS</u> Type text here									
1.1. Company Information									
1.1.1. Company Name:	Haskell Office DBA Haskell Education								
1.1.2. Corporate Street Address:	273 Montgomery Ave., Bala Cynwyd, PA 19004								
1.1.3. Website:	www.haskelleducation.com								
1.1.4. Formation. In what year was the company formed? For how long has your company been operating under its present business name? If your company has changed its business name, include the most recent prior business name and the year of the name change.	Initially formed as Haskell of Pittsburgh in 1947. The Robins Brothers renamed it Haskell Office when they took ownership in 2002 and have operated under that name for the past 21 years. The DBA of Haskell Education was created in 2019.								
1.1.5. Primary Point of Contact. Provide information about the Respondent representative/contact person authorized to answer questions regarding the proposal submitted by your company:	<table border="1" style="width: 100%; border-collapse: collapse;"> <tr> <td style="width: 30%; padding: 2px;">Contact Name:</td> <td style="padding: 2px;">Tim Kerfien</td> </tr> <tr> <td style="padding: 2px;">Title:</td> <td style="padding: 2px;">Customer Support Supervisor/Contract Administrator</td> </tr> <tr> <td style="padding: 2px;">Phone:</td> <td style="padding: 2px;">616-278-1010</td> </tr> <tr> <td style="padding: 2px;">E-Mail Address:</td> <td style="padding: 2px;">tkerfien@haskelloffice.com</td> </tr> </table>	Contact Name:	Tim Kerfien	Title:	Customer Support Supervisor/Contract Administrator	Phone:	616-278-1010	E-Mail Address:	tkerfien@haskelloffice.com
Contact Name:	Tim Kerfien								
Title:	Customer Support Supervisor/Contract Administrator								
Phone:	616-278-1010								
E-Mail Address:	tkerfien@haskelloffice.com								
1.1.6. Authorized Representative. Print or type the name of the Respondent representative authorized to address contractual issues, including the authority to execute a contract on behalf of Respondent, and to whom legal notices regarding contract termination or breach, should be sent (if not the same individual as in 1.1.9., provide the following information on each such representative and specify their function).	<table border="1" style="width: 100%; border-collapse: collapse;"> <tr> <td style="width: 30%; padding: 2px;">Contact Name:</td> <td style="padding: 2px;">Tim Kerfien</td> </tr> <tr> <td style="padding: 2px;">Title:</td> <td style="padding: 2px;">Customer Support Supervisor / Contract Administrator</td> </tr> <tr> <td style="padding: 2px;">Phone:</td> <td style="padding: 2px;">616-278-1010</td> </tr> <tr> <td style="padding: 2px;">E-Mail Address:</td> <td style="padding: 2px;">tkerfien@haskelloffice.com</td> </tr> </table>	Contact Name:	Tim Kerfien	Title:	Customer Support Supervisor / Contract Administrator	Phone:	616-278-1010	E-Mail Address:	tkerfien@haskelloffice.com
Contact Name:	Tim Kerfien								
Title:	Customer Support Supervisor / Contract Administrator								
Phone:	616-278-1010								
E-Mail Address:	tkerfien@haskelloffice.com								
1.2. Financial Strength & Legal Considerations									
1.2.1. Financial Strength. Demonstrate your financial strength and stability with meaningful data. This could include, but is not limited to, such items as financial statements, SEC filings, credit & bond ratings, letters of credit, and detailed reference letters.	See attachment marked 1.2.1 Financial Strength This document should be considered "Trade Secret" and redacted from any future use of the RFP response.								
Note: If the information disclosed in your response is considered "Trade Secret" as defined in Ohio Revised Code, Respondents may mark the information as a "Trade Secret" and the response									

will be redacted from any future use of the RFP response.	
1.2.2. <i>Bankruptcy & Insolvency.</i> Describe any bankruptcy or insolvency for your organization (or its predecessors, if any) or any principal of the firm in the last three (3) years.	None
1.2.3. <i>Litigation.</i> Describe any litigation in which your company has been involved in the last three (3) years and the status of that litigation.	See attachment marked 1.2.3
1.3. Industry Qualifications	
1.3.1. <i>Company Identification.</i> How is your organization best identified? Is it a manufacturer, distributor, dealer, reseller, or service provider?	We are a manufacturer.
1.3.2. <i>Manufacturer Authorization.</i> If your company is best described as a distributor, dealer, reseller, or similar entity please certify that your organization is authorized to sell the products and services at the price points disclosed in this proposal.	N/A
1.3.3. <i>Authorized Distributors, Agents, Dealers, or Resellers.</i> Describe the different channels in which this contract will be made available to Equalis Group Members. Your response should include, but is not limited to, whether your organization will serve as the single point of sale or if the contract will be made available through a network of distributors, agents, dealers, or resellers. NOTE: Respondents intending to authorize distributors, agents, dealers, or resellers must complete <u>Proposal Form 7 - Dealer, Distributor and Reseller Authorization Form.</u>	Equalis Group Members will have access to our full list of national and regional dealers and resellers. See attachment marked 1.3.3 for list.
1.3.4. <i>Network Relationship.</i> If your company is best described as a manufacturer or service provider, please describe how your dealer network operates to sell and deliver the Products & Services proposed in this RFP. If applicable, is your network independent or company owned?	We have a mixed model of employed regional sales managers and contracted rep groups with a national network of dealers and resellers at their disposal to successfully promote the products and services proposed in this RFP.
1.3.5. <i>Industry Experience.</i> How long has your company provided the products and	Haskell Office has been selling office furniture, filing and storage since its founding in 2002. Haskell Education has been selling

<p>services outlined in your proposal? What percentage of your company's revenue in each of the last three (3) full calendar years was generated from these products and services?</p>	<p>educational furniture to the K-12 public and private market and Higher Education since 2015.</p>
<p>1.3.6. Geographic Reach. Describe your company's <u>current</u> service area in the United States and which areas you intend to offer services under a resulting contract if awarded.</p>	<p>Our network of Regional Sales Managers, rep groups and dealers cover all 50 states, US territories and International Sales</p>
<p>1.3.7. Certifications and Licenses. Provide a detailed explanation outlining the licenses and certifications that are i) required to be held, and ii) actually held by your organization (including third parties and subcontractors that you use). Has your company maintained these certifications on an ongoing basis? If not, when and why did your company lose any referenced certifications?</p> <p>NOTE: Provide copies of any of the certificates or licenses included in your response in Proposal Form 5 - Certifications and Licenses.</p>	<p>None</p>
<p>1.4. Public Sector Experience</p>	
<p>1.4.1. Public Sector Cooperative Contracts. Provide a list of the public sector cooperative contracts (e.g., state term contracts, public sector cooperatives, etc.) you currently hold or are authorized to sell through (if contracts are held with a manufacturer) and the annual revenue through those contracts in each of the last three (3) calendar year.</p> <p>NOTE: Please exclude information and data associated with Federal or GSA contracts.</p>	<p>See Attachment 1.4.1 Public Sector Cooperative Contracts</p>
<p>1.4.2. Education Success. What is the i) total dollar amount, and ii) percentage of your company's total annual revenue generated by sales to educational institutions (i.e., K-12 schools & school districts and high education)?</p>	
<p>1.4.3. Government Success. What is the i) total dollar amount, and ii) percentage of your company's total annual revenue generated by sales to local governments</p>	

<p>(i.e., municipalities, counties, special districts, and state agencies)?</p>	
<p>1.4.4. Customer References. Provide references of at least five (5) local government or educational institution customers for which your company has provided products and services similar in nature and scope to those defined in this RFP in the last three (3) years. Each reference should include:</p> <ul style="list-style-type: none"> a. Customer contact person and their title, telephone number, and email address; b. A brief description of the products and services provided by your company; c. Customer relationship starting and ending dates; and, d. Notes or other pertinent information relating to the customer and/or the products and services your company provided. 	<p>See Attachment marked: 1.4.4 Customer References</p>
<p>2. <u>Products & Services</u></p>	
<p>2.1. Products & Services</p>	
<p>2.1.1. Product & Services Description(s). Provide a detailed description of the products and services you are offering as a part of your proposal.</p> <p>Your response may include, but is not limited to, information related to product or market focus, differentiators, manufacturing capabilities & advantages, warranty information, turnkey capabilities, installation or set-up, training services, maintenance services, or any other piece of information that would help understand the breadth and depth of your products and service offering.</p> <p><u>IMPORTANT.</u> This description along with the products and services included in the <u>Attachment B – Cost Proposal</u> will be utilized to define the</p>	<p>See attachment marked 2.1.1 Products and Services</p>

overall products and services available under a resulting contract.	
2.1.2. Value-Add or Additional Offering. Please include any additional products and services not included in the scope of the solicitation that you think will enhance and add value to this contract’s participating agencies.	See attachment marked 2.1.2 Value Add
2.1.3. Open Market Products. Provide a detailed description of your ability to accommodate requests for Open Market Products. Open Market Products is a category of products that cannot be found in your standard catalog offering or non-inventoried products.	We do not offer open market products.
2.1.4. Warranty. Provide a copy of the manufacturer’s warranty. If required, please attach the warranty as an attachment, as instructed in this document. Describe notable features and/or characteristics of the warranty that a public sector customer would find interesting or appealing. Pricing related to the any extended warranty options must be included in <u>Attachment B – Cost Proposal.</u>	See attachment marked 2.1.4 Warranty

3. Business Operations

3.1. Logistics

3.1.1. Store & Showroom Locations; Distribution & Shipping Capabilities. Describe how supplier proposes to distribute the products & services in Respondent’s defined geographic reach. Your response may include, but is not limited to, information related to the number of store or showroom locations, distribution facilities, supply chain partners, fill rates, on-time delivery rates, and your ability to accommodate expedited orders.	See attachment marked: 3.1.1 Showroom Locations/Distribution Centers
---	--

3.2. Customer Service

3.2.1. Customer Service Department. Describe your company’s customer service department & operations. Your	See attachment marked 3.2.1 Customer Service
---	--

<p>description may include, but is not limited to, hours of operation, number and location of service centers, parts outlets, number of customer service representatives. Clarify if the service centers are owned by your company or if they are a network of subcontractors.</p>	
<p>3.3. Customer Set Up; Order & Invoice Processing; Payment</p>	
<p>3.3.1. Proposal Development, Order, and Invoice Process. Describe your company's proposal development, order, and invoice process.</p>	<p>Equalis Group Members will work with our trained dealers to select products for their proposals. Quotes will be returned within 24 hours after requested. Orders will be emailed in and processed within 24 hours. Invoices are generated 24 hours after the order ships. Invoicing terms are net 30 days.</p>
<p>3.3.2. Financing. Does your company offer any financing options or programs? If yes, describe the financing options available to Members.</p>	<p>No</p>
<p>3.4. Sustainability, Reclamation, and Recycling Initiatives</p>	
<p>3.4.1. Sustainable Company Initiatives. Describe the ways in which your company is addressing the issue of sustainability.</p>	<p>See attachment marked 3.4.1 Sustainable Company Initiatives</p>
<p>4. <u>PRICING</u></p>	
<p>4.1. Cost Proposal</p>	
<p>4.1.1. Pricing Model. Provide a description of your pricing model or methodology identifying how the model works for the products and services included in your proposal.</p>	<p>Tiered discount structure based on discount off our list prices. Discounts will be taken off submitted price list dated 8/21/23.</p>
<p>4.1.2. Auditable. Describe how the proposed pricing model is able to be audited by public sector agencies or CCOG to assure compliance with pricing in the Master Agreement.</p>	<p>Comparing the list price provided less the volume discount awarded will allow it to be audited for compliance.</p>

<p>4.1.3. Cost Proposal Value. Which of the following statements best describes the pricing offered included in Respondent's cost proposal.</p>	<p>The prices offered in your Cost Proposal are:</p> <p><input type="checkbox"/> lower than what you offer other group purchasing organizations, cooperative purchasing organizations, or state purchasing departments.</p> <p><input checked="" type="checkbox"/> equal to what you offer other group purchasing organizations, cooperative purchasing organizations, or state purchasing departments.</p> <p><input type="checkbox"/> higher than what you offer other group purchasing organizations, cooperative purchasing organizations, or state purchasing departments.</p> <p><input type="checkbox"/> not applicable. Please explain below.</p> <p>Click or tap here to enter text.</p>
<p>4.1.4. Additional Savings. Describe any quantity or volume discounts or rebate programs included in your Cost Proposal.</p>	<p>Volume savings are noted on cost proposal.</p>
<p>4.1.5. Cost of Shipping. Is the cost of shipping included in the pricing submitted with your response? If no, describe how cost associated with freight, shipping, and delivery are calculated.</p>	<p>Yes</p>
<p>4.1.6. Pricing Open Market or Sourced Goods. If relevant, propose a method for the pricing of Open Market Items. For example, you may supply such items "at cost" or "at cost plus a percentage" or you supply a quote for each such request.</p> <p>NOTE: For a definition of Open Market Items, please refer to <u>Part One, Section 5.4 – Other Pricing Scenarios.</u></p>	<p>Not relevant</p>
<p>4.1.7. Total Cost of Acquisition. Identify any components included in the total cost of acquisition that are <i>NOT</i> included in the pricing submitted with your response. This cost includes all additional charges that are not directly identified as freight or shipping charges. For example, list costs for items like installation, set up, mandatory training, or initial inspection. Identify any parties that impose such costs and their relationship to the Respondent.</p>	<p>Any applicable additional charges are noted on cost proposal.</p>

5. GO-TO-MARKET STRATEGY

5.1. Respondent Organizational Structure & Staffing of Relationship	
<p>5.1.1. Key Contacts. Provide contact information and resumes for the person(s) who will be responsible for the following areas;</p> <ol style="list-style-type: none"> 1. Executive Contact 2. Contract Manager 3. Sales Leader 4. Reporting Contact 5. Marketing Contact. <p>***Indicate who the primary contact will be if it is not the Sales Leader.</p>	<p>Executive Contact/Sales Leader: Cristel Hutchinson, VP of Sales chutchinson@haskelleducation.com (360) 529-7074</p> <p>Primary contact/Contract Manager: Tim Kerfien, Customer Support Supervisor / Contract Administrator tkerfien@haskelloffice.com (616) 278-1010</p> <p>Reporting Contact: Mindy Gilbert mgilbert@haskelloffice.com (616) 278-1004</p> <p>Marketing Contact: John Myers, Director of Marketing, jmyers@haskelleducation.com (614) 980-8314</p>
<p>5.1.2. Sales Organization. Provide a description of your sales organization, including key staff members, the size of the organization, in-house vs. third-party sales resources, geographic territories, vertical market segmentation, etc.</p>	<p>See attachment marked 5.1.2 Haskell Education Organizational Chart</p>
5.2. Contract Implementation Strategy & Expectations	
<p>5.2.1. Contract Expectation. What are your company's expectations in the event of a contract award?</p>	<p><u>See attachment marked 5.2.1</u></p>
<p>5.2.2. Five (5) Year Sales Vision & Strategy. Describe your company's vision and strategy to leverage a resulting contract with Equalis over the next five (5) years. Your response may include but is not limited to; the geographic or public sector vertical markets being targeted; your strategy for acquiring new business and retaining existing business; how the contract will be deployed with your sales team; how you will market the contract, including deployment of the contract on your company website; how you will market the contract, including deployment of the contract on your company website; and the time frames in which this will be completed.</p>	<p><u>See attachment marked 5.2.2</u></p>
<p>5.2.3. Sales Objectives. What are your top line sales objectives in each of the five (5) years if awarded this contract?</p>	<p><u>See attachment marked 5.2.3</u></p>

6. ADMIN FEE & REPORTING

6.1. Administration Fee & Reporting

6.1.1. Administrative Fee. Equalis Group only generates revenue when the Winning Supplier generates revenue based on contract utilization by current and future Members.

The administrative fee is normally calculated as a percentage of the total Spend for agencies accessing product and services through the Master Agreement and is typically two percent (2%) to three percent (3%). In some categories, a flat fee or another fee structure may be acceptable.

Please provide your organization's proposed Administrative Fee percentage or structure.

NOTE: The proposed Administrative Fee language for this contract is based on the terms disclosed in the **Attachment A – Model Administration Agreement**.

Haskell Education is offering a 2% administration fee payable per the terms disclosed in Attachment A

6.1.2. Sales & Administrative Fee Reporting. Equalis Group requires monthly reports detailing sales invoiced the prior month and associated Administrative Fees earned by the 15th of each month. Confirm that your company will meet this reporting requirement. If not, explain why and propose an alternative time schedule for providing these reports to Equalis Group.

Yes, we will confirm this reporting requirement.

6.1.3. Self-Audit. Describe any self-audit process or program that you plan to employ to verify compliance with your proposed contract with Equalis Group. This process includes ensuring that you sales organization provides and Members obtain the correct pricing, reports reflect all sales made under the Contract, and Winning Supplier remit the proper admin fee to Equalis.

We will perform monthly audits to track the status of quotes, open orders, invoiced orders and fees due.

PROPOSAL FORM 2: COST PROPOSAL

A template for the Cost Proposal has been included as **Attachment B** and must be uploaded as a separate attachment to a Respondent's proposal submission. Respondents are permitted to revise any part of the spreadsheet to the Cost Proposal to accurately reflect the column titles, details, discounts, pricing categories of products, services, and solutions being offered to Equalis Group Members.

Respondent's Cost Proposal must include the information requested in **Section 5 – Cost Proposal & Pricing**.

NOTE: Cost Proposals will remain sealed and will only be opened and reviewed for those Respondents that meet the minimum Technical Proposal score threshold as described in **Section 6.2 - Evaluation and Scoring of Proposals**.

(The rest of this page is intentionally left blank)

PROPOSAL FORM 3: DIVERSITY VENDOR CERTIFICATION PARTICIPATION

Diversity Vendor Certification Participation - It is the policy of some Members participating in Equalis Group to involve minority and women business enterprises (M/WBE), small and/or disadvantaged business enterprises, disable veterans business enterprises, historically utilized businesses (HUB) and other diversity recognized businesses in the purchase of goods and services. Respondents shall indicate below whether or not they hold certification in any of the classified areas and include proof of such certification with their response.

a. Minority Women Business Enterprise

Respondent certifies that this firm is an MWBE: Yes No

List certifying agency: [Click or tap here to enter text.](#)

b. Small Business Enterprise (SBE) or Disadvantaged Business Enterprise (“DBE”)

Respondent certifies that this firm is a SBE or DBE: Yes No

List certifying agency: [Click or tap here to enter text.](#)

c. Disabled Veterans Business Enterprise (DVBE)

Respondent certifies that this firm is an DVBE: Yes No

List certifying agency: [Click or tap here to enter text.](#)

d. Historically Underutilized Businesses (HUB)

Respondent certifies that this firm is an HUB: Yes No

List certifying agency: [Click or tap here to enter text.](#)

e. Historically Underutilized Business Zone Enterprise (HUBZone)

Respondent certifies that this firm is an HUBZone: Yes No

List certifying agency: [Click or tap here to enter text.](#)

f. Other

Respondent certifies that this firm is a recognized diversity certificate holder: Yes No

List certifying agency: [Click or tap here to enter text.](#)

PROPOSAL FORM 4: CERTIFICATIONS AND LICENSES

Provide a copy of all current licenses, registrations and certifications issued by federal, state and local agencies, and any other licenses, registrations or certifications from any other governmental entity with jurisdiction, allowing Respondent to provide the products and services included in their proposal which can include, but not limited to licenses, registrations or certifications. M/WBE, HUB, DVBE, small and disadvantaged business certifications and other diverse business certifications, as well as manufacturer certifications for sales and service must be included if applicable.

Please also list and include copies of any certificates you hold that would show value for your response and was not already included with the requested information above.

None

(The rest of this page is intentionally left blank)

PROPOSAL FORM 5: UNRESOLVED FINDINGS FOR RECOVERY

O.R.C. Chapter 9.24 prohibits CCOG from awarding a contract to any entity against whom the Auditor of State has issued a finding for recovery, if such finding for recovery is “unresolved” at the time of award. By submitting a proposal, a Respondent warrants that it is not now, and will not become, subject to an “unresolved” finding for recovery under **O.R.C. Chapter 9.24** prior to the award of any contract arising out of this RFP, without notifying CCOG of such finding. The Proposal Review Team will not evaluate a proposal from any Respondent whose name, or the name of any of the subcontractors proposed by the Respondent, appears on the website of the Auditor of the State of Ohio as having an “unresolved” finding for recovery.

Is your company the subject of any unresolved findings for recoveries?

- Yes
- No

PROPOSAL FORM 6: MANDATORY DISCLOSURES

1. *Mandatory Contract Performance Disclosure.*

Disclose whether your company's performance and/or the performance of any of the proposed subcontractor(s) under contracts for the provision of products and services that are the same or similar to those to be provided for the Program which is the subject of this RFP has resulted in any formal claims for breach of those contracts. For purposes of this disclosure, "**formal claims**" means any claims for breach that have been filed as a lawsuit in any court, submitted for arbitration (whether voluntary or involuntary, binding or not), or assigned to mediation. For any such claims disclosed, fully explain the details of those claims, including the allegations regarding all alleged breaches, any written or legal action resulting from those allegations, and the results of any litigation, arbitration, or mediation regarding those claims, including terms of any settlement. While disclosure of any formal claims will not automatically disqualify a Respondent from consideration, at the sole discretion of Equalis Group, such claims and a review of the background details may result in a rejection of a Respondent's proposal. Equalis Group will make this decision based on the Proposal Review Team's determination of the seriousness of the claims, the potential impact that the behavior that led to the claims could have on the Respondent's performance of the work, and the best interests of Members.

Provide statement here. We have nothing to disclose.

2. *Mandatory Disclosure of Governmental Investigations.*

Indicate whether your company and/or any of the proposed subcontractor(s) has been the subject of any adverse regulatory or adverse administrative governmental action (federal, state, or local) with respect to your company's performance of services similar to those described in this RFP. If any such instances are disclosed, Respondents must fully explain, in detail, the nature of the governmental action, the allegations that led to the governmental action, and the results of the governmental action including any legal action that was taken against the Respondent by the governmental agency. While disclosure of any governmental action will not automatically disqualify a Respondent from consideration, such governmental action and a review of the background details may result in a rejection of the Respondent's proposal at Group's sole discretion. Equalis Group will make this decision based on the Proposal Review Team's determination of the seriousness of the claims, the potential impact that the behavior that led to the claims could have on the Respondent's performance of the work, and the best interests of Members.

Provide statement here. We have nothing to disclose.

PROPOSAL FORM 7: DEALER, RESELLER, AND DISTRIBUTOR AUTHORIZATION

CCOG allows Suppliers to authorize dealers, distributors, and resellers to sell the products and services made available through, and consistent with the Terms and Conditions set forth in, the Master Agreement. If Supplier intends to authorize their dealers, distributors, or resellers access to the Master Agreement in the event of a contract award Supplier must provide a list, either in the form of a document or a weblink, to identify those organizations who are being authorized access to the Master Agreement.

Will the Supplier authorize dealers, distributors, resellers access to Master Agreement?

Yes

No

If yes, how will Supplier disclose which organization(s) will have access to the Master Agreement? This list can be updated from time to time upon CCOG's approval.

Respondent Response: See attachment marked 1.3.3 List of Dealers and Resellers

PROPOSAL FORM 8: MANDATORY SUPPLIER & PROPOSAL CERTIFICATIONS

CCOG may not enter into contracts with any suppliers who have been found to be ineligible for state contracts under specific federal or Ohio statutes or regulations. Companies responding to any CCOG RFP MUST certify that they are NOT ineligible by signing each of the statements below. **Failure to provide proper affirming signature on any of these statements will result in a Respondent's proposal being deemed nonresponsive to this RFP.**

I, Timothy P. Kerfien, hereby certify and affirm that Haskell Office DBA Haskell Education, has not been debarred, suspended, proposed for debarment, declared ineligible, or voluntarily excluded from participation in transactions by the United States Department of Labor, the United States Department of Health and Human Services, or any other federal department or agency as set forth in 29 CFR Part 98, or 45 CFR Part 76, or other applicable statutes.

AND

I, Timothy P. Kerfien, hereby certify and affirm that Haskell Office DBA Haskell Education, is in compliance with all federal, state, and local laws, rules, and regulations, including but not limited to the Occupational Safety and Health Act and the Ohio Bureau of Employment Services and the following:

- Not penalized or debarred from any public contracts or falsified certified payroll records or any other violation of the Fair Labor Standards Act in the last three (3) years;
- Not found to have violated any worker's compensation law within the last three (3) years;
- Not violated any employee discrimination law within the last three (3) years;
- Not have been found to have committed more than one (1) willful or repeated OSHA violation of a safety standard (*as opposed to a record keeping or administrative standard*) in the last three (3) years;
- Not have an Experience Modification Rating of greater than 1.5 (a penalty-rated employer) with respect to the Bureau of Workers' Compensation risk assessment rating; and
- Not have failed to file any required tax returns or failed to pay any required taxes to any governmental entity within the past three (3) years.

AND

I, (Timothy P, Kerfien), hereby certify and affirm that (Haskell Office DBA Haskell Education), is not on the list established by the Ohio Secretary of State, pursuant to **ORC Section 121.23**, which identifies persons and businesses with more than one unfair labor practice contempt of court finding against them.

AND

I, (Timothy P. Kerfien), hereby certify and affirm that (Haskell Office DBA Haskell Education) either is not subject to a finding for recovery under **ORC Section 9.24**, or has taken appropriate remedial steps required under that statute to resolve any findings for recovery, or otherwise qualifies under that section to enter into contracts with CCOG.

I, (Timothy P. Kerfien), hereby affirm that this proposal accurately represents the capabilities and qualifications of (Haskell Office DBA Haskell Education), and I hereby affirm that the cost(s) proposed to CCOG for the performance of services and/or provision of goods covered in this proposal in response to this CCOG RFP is a firm fixed price structure as described in the Cost Proposal, inclusive of all incidental as well as primary costs. (*Failure to provide the proper affirming signature on this item may result in the disqualification of your proposal.*)

PROPOSAL FORM 9: CLEAN AIR ACT & CLEAN WATER ACT

The Respondent is in compliance with all applicable standards, orders or regulations issued pursuant to the Clean Air Act of 1970, as Amended (42 U.S. C. 1857 (h), Section 508 of the Clean Water Act, as amended (33 U.S.C. 1368), Executive Order 117389 and Environmental Protection Agency Regulation, 40 CFR Part 15 as required under OMB Circular A-102, Attachment O, Paragraph 14 (1) regarding reporting violations to the grantor agency and to the United States Environment Protection Agency Assistant Administrator for the Enforcement.

Authorized signature:



Printed Name:

Timothy P. Kerfien

Company Name:

Haskell Office DBA Haskell Education

273 Montgomery Ave. Bala Cynwyd, PA

19004

Mailing Address:

Email Address:

tkerfien@haskelloffice.com

Customer Support Supervisor / Contract

Job Title:

Administrator

PROPOSAL FORM 10: DEBARMENT NOTICE

I, the Respondent, certify that my company has not been debarred, suspended or otherwise ineligible for participation in Federal Assistance programs under Executive Order 12549, "Debarment and Suspension", as described in the Federal Register and Rules and Regulations.

Respondents Name: Timothy P. Kerfien

Mailing Address: 273 Montgomery Ave. Bala Cynwyd, PA
19004

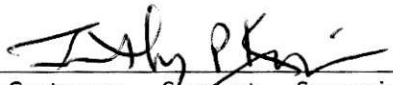
Signature 

Title of Signatory: Customer Support Supervisor/Contract Administrator

PROPOSAL FORM 11: LOBBYING CERTIFICATIONS

Submission of this certification is a prerequisite for making or entering into this transaction and is imposed by **Section 1352, Title 31, U.S. Code**. This certification is a material representation of fact upon which reliance was placed when this transaction was made or entered into. Any person who fails to file the required certification shall be subject to civil penalty of not less than ten thousand dollars (\$10,000) and not more than one hundred thousand dollars (\$100,000) for each such failure.

The undersigned certifies, to the best of his/her knowledge and belief, on behalf of Respondent that:

1. No Federal appropriated funds have been paid or will be paid on behalf of the undersigned, to any person for influencing or attempting to influence an officer or employee of any agency, a Member of Congress, an officer or employee of Congress, or an employee of a Member of Congress in connection with the awarding of a Federal contract, the making of a Federal grant, the making of a Federal loan, the entering into a cooperative agreement, and the extension, continuation, renewal, amendment, or modification of a Federal contract, grant, loan, or cooperative agreement.
2. If any funds other than Federal appropriated funds have been or will be paid to any person for influencing or attempting to influence an officer or employee of any agency, a Member of Congress, an officer or employee of Congress, or an employee of a Member of Congress in connection with this Federal contract or cooperative agreement, the undersigned shall complete and submit Standard Form LLL, "Disclosure of Lobbying Activities," in accordance with its instructions.
3. The undersigned shall require that the language of this certification be included in the award documents for all covered sub-awards exceeding one hundred thousand dollars (\$100,000) in Federal funds at all appropriate tiers and that all sub-recipients shall certify and disclose accordingly.

Signature:



Date:

10/30/23

PROPOSAL FORM 12: CONTRACTOR CERTIFICATION REQUIREMENTS

1. Contractor's Employment Eligibility

By entering the contract, Contractor warrants compliance with the Federal Immigration and Nationality Act (FINA), and all other federal and state immigration laws and regulations. The Contractor further warrants that it is in compliance with the various state statutes of the states it will operate this contract in.

Participating Government Entities including School Districts may request verification of compliance from any Contractor or subcontractor performing work under this Contract. These Entities reserve the right to confirm compliance in accordance with applicable laws.

Should the Participating Entities suspect or find that the Contractor or any of its subcontractors are not in compliance, they may pursue any and all remedies allowed by law, including, but not limited to: suspension of work, termination of the Contract for default, and suspension and/or debarment of the Contractor. All costs necessary to verify compliance are the responsibility of the Contractor.

The Respondent complies and maintains compliance with the appropriate statutes which requires compliance with federal immigration laws by State employers, State contractors and State subcontractors in accordance with the E-Verify Employee Eligibility Verification Program.

Contractor shall comply with governing board policy of the CCOG Participating entities in which work is being performed.

2. Fingerprint & Criminal Background Checks

If required to provide services on school district property at least five (5) times during a month, contractor shall submit a full set of fingerprints to the school district if requested of each person or employee who may provide such service. Alternately, the school district may fingerprint those persons or employees. An exception to this requirement may be made as authorized in Governing Board policy. The district shall conduct a fingerprint check in accordance with the appropriate state and federal laws of all contractors, subcontractors or vendors and their employees for which fingerprints are submitted to the district. Contractor, subcontractors, vendors and their employees shall not provide services on school district properties until authorized by the District.

The Respondent shall comply with fingerprinting requirements in accordance with appropriate statutes in the state in which the work is being performed unless otherwise exempted.

Contractor shall comply with governing board policy in the school district or Participating Entity in which work is being performed.

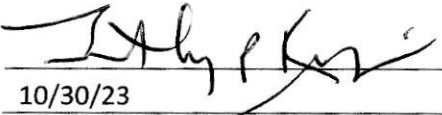
Signature: 
Date: 10/30/23

PROPOSAL FORM 13: BOYCOTT CERTIFICATION

Respondent must certify that during the term of any Agreement, it does not boycott Israel and will not boycott Israel. "Boycott" means refusing to deal with, terminating business activities with, or otherwise taking any action that is intended to penalize, inflict economic harm on, or limit commercial relations specifically with Israel, or with a person or entity doing business in Israel or in an Israeli-controlled territory, but does not include an action made for ordinary business purposes.

Does Respondent agree? TPK

(Initials of Authorized Representative)

PROPOSAL FORM 14: FEDERAL FUNDS CERTIFICATION FORMS

When a participating agency seeks to procure goods and services using funds under a federal grant or contract, specific federal laws, regulations, and requirements may apply in addition to those under state law. This includes, but is not limited to, the procurement standards of the Uniform Administrative Requirements, Cost Principles and Audit Requirements for Federal Awards, 2 CFR 200 (sometimes referred to as the “Uniform Guidance” or “EDGAR” requirements).

All Respondents submitting proposals must complete this Federal Funds Certification Form regarding Respondent’s willingness and ability to comply with certain requirements which may be applicable to specific participating agency purchases using federal grant funds. This completed form will be made available to Members for their use while considering their purchasing options when using federal grant funds. Members may also require Supplier Partners to enter into ancillary agreements, in addition to the contract’s general terms and conditions, to address the member’s specific contractual needs, including contract requirements for a procurement using federal grants or contracts.

For each of the items below, respondent should certify their agreement and ability to comply, where applicable, by having respondents authorized representative complete and initial the applicable lines after each section and sign the acknowledgment at the end of this form. If a Respondent fails to complete any item in this form, CCOG will consider the Respondent’s response to be that they are unable or unwilling to comply. A negative response to any of the items may, if applicable, impact the ability of a participating agency to purchase from the Supplier Partner using federal funds.

1. *Supplier Partner Violation or Breach of Contract Terms*

Contracts for more than the simplified acquisition threshold currently set at one hundred fifty thousand dollars (\$150,000), which is the inflation adjusted amount determined by the Civilian Agency Acquisition Council and the Defense Acquisition Regulations Council (Councils) as authorized by 41 USC 1908, must address administrative, contractual, or legal remedies in instances where Supplier Partners violate or breach contract terms, and provide for such sanctions and penalties as appropriate.

Any contract award will be subject to Terms and Conditions of the Master Agreement, as well as any additional terms and conditions in any purchase order, participating agency ancillary contract, or Member construction contract agreed upon by Supplier Partner and the participating agency which must be consistent with and protect the participating agency at least to the same extent as the CCOG Terms and Conditions.

The remedies under the contract are in addition to any other remedies that may be available under law or in equity. By submitting a proposal, you agree to these Supplier Partner violation and breach of contract terms.

Does Respondent agree? TPK

(Initials of Authorized Representative)

2. *Termination for Cause or Convenience*

When a participating agency expends federal funds, the participating agency reserves the right to immediately terminate any agreement in excess of ten thousand dollars (\$10,000) resulting from this procurement process in the event of a breach or default of the agreement by Offeror in the event Offeror fails to: (1) meet schedules, deadlines, and/or delivery dates within the time specified in the procurement solicitation, contract, and/or a purchase order; (2) make any payments owed; or (3) otherwise perform in accordance with the contract and/or the procurement solicitation. Participating agency also reserves the right to terminate the contract immediately, with written notice to offeror, for convenience, if participating agency believes, in its sole discretion that it is in the best interest of participating agency to do so. Respondent

will be compensated for work performed and accepted and goods accepted by participating agency as of the termination date if the contract is terminated for convenience of participating agency. Any award under this procurement process is not exclusive and participating agency reserves the right to purchase goods and services from other offerors when it is in participating agency's best interest.

Does Respondent agree? TPK

(Initials of Authorized Representative)

3. Equal Employment Opportunity

Except as otherwise provided under 41 CFR Part 60, all participating agency purchases or contracts that meet the definition of "federally assisted construction contract" in 41 CFR Part 60-1.3 shall be deemed to include the equal opportunity clause provided under 41 CFR 60-1.4(b), in accordance with Executive Order 11246, "Equal Employment Opportunity" (30 FR 12319, 12935, 3 CFR Part, 1964-1965 Comp., p. 339), as amended by Executive Order 11375, "Amending Executive Order 11246 Relating to Equal Employment Opportunity," and implementing regulations at 41 CFR Part 60, "Office of Federal Contract Compliance Programs, Equal Employment Opportunity, Department of Labor."

The equal opportunity clause provided under 41 CFR 60-1.4(b) is hereby incorporated by reference. Supplier Partner agrees that such provision applies to any participating agency purchase or contract that meets the definition of "federally assisted construction contract" in 41 CFR Part 60-1.3 and Supplier Partner agrees that it shall comply with such provision.

Does Respondent agree? TPK

(Initials of Authorized Representative)

4. Davis-Bacon Act

When required by Federal program legislation, Supplier Partner agrees that, for all participating agency prime construction contracts/purchases in excess of two thousand dollars (\$2,000), Supplier Partner shall comply with the Davis-Bacon Act (40 USC 3141-3144, and 3146-3148) as supplemented by Department of Labor regulations (29 CFR Part 5, "Labor Standards Provisions Applicable to Contracts Covering Federally Financed and Assisted Construction"). In accordance with the statute, Supplier Partner is required to pay wages to laborers and mechanics at a rate not less than the prevailing wages specified in a wage determinate made by the Secretary of Labor. In addition, Supplier Partner shall pay wages not less than once a week.

Current prevailing wage determinations issued by the Department of Labor are available at www.wdol.gov. Supplier Partner agrees that, for any purchase to which this requirement applies, the award of the purchase to the Supplier Partner is conditioned upon Supplier Partner's acceptance of the wage determination.

Supplier Partner further agrees that it shall also comply with the Copeland "Anti-Kickback" Act (40 USC 3145), as supplemented by Department of Labor regulations (29 CFR Part 3, "Contractors and Subcontractors on Public Building or Public Work Financed in Whole or in Part by Loans or Grants from the United States". The Act provides that each Supplier Partner or subrecipient must be prohibited from inducing, by any means, any person employed in the construction, completion, or repair of public work, to give up any part of the compensation to which he or she is otherwise entitled.

Does Respondent agree? TPK

(Initials of Authorized Representative)

5. Contract Work Hours and Safety Standards Act

Where applicable, for all participating agency contracts or purchases in excess of one hundred thousand dollars (\$100,000) that involve the employment of mechanics or laborers, Supplier Partner agrees to comply with 40 USC 3702 and 3704, as supplemented by Department of Labor regulations (29 CFR Part 5). Under 40 USC 3702 of the Act, Supplier Partner is required to compute the wages of every mechanic and laborer on the basis of a standard work week of forty (40) hours. Work in excess of the standard work week is permissible provided that the worker is compensated at a rate of not less than one and a half times the basic rate of pay for all hours worked in excess of forty (40) hours in the work week. The requirements of 40 USC 3704 are applicable to construction work and provide that no laborer or mechanic must be required to work in surroundings or under working conditions which are unsanitary, hazardous or dangerous. These requirements do not apply to the purchases of supplies or materials or articles ordinarily available on the open market, or contracts for transportation or transmission of intelligence.

Does Respondent agree? TPK

(Initials of Authorized Representative)

6. Right to Inventions Made Under a Contract or Agreement

If the participating agency's Federal award meets the definition of "funding agreement" under 37 CFR 401.2(a) and the recipient or subrecipient wishes to enter into a contract with a small business firm or nonprofit organization regarding the substitution of parties, assignment or performance or experimental, developmental, or research work under that "funding agreement," the recipient or subrecipient must comply with the requirements of 37 CFR Part 401, "Rights to Inventions Made by Nonprofit Organizations and Small Business Firms Under Government Grants, Contracts and Cooperative Agreements," and any implementing regulations issued by the awarding agency.

Supplier Partner agrees to comply with the above requirements when applicable.

Does Respondent agree? TPK

(Initials of Authorized Representative)

7. Clean Air Act and Federal Water Pollution Control Act

Clean Air Act (42 USC 7401-7671q.) and the Federal Water Pollution Control Act (33 USC 1251-1387), as amended – Contracts and subgrants of amounts in excess of one hundred fifty thousand dollars (\$150,000) must contain a provision that requires the non-Federal award to agree to comply with all applicable standards, orders, or regulations issued pursuant to the Clean Air Act (42 USC 7401-7671q.) and the Federal Water Pollution Control Act, as amended (33 USC 1251-1387). Violations must be reported to the Federal awarding agency and the Regional Office of the Environmental Protection Agency (EPA).

When required, Supplier Partner agrees to comply with all applicable standards, orders, or regulations issued pursuant to the Clean Air Act and the Federal Water Pollution Control Act.

Does Respondent agree? TPK

(Initials of Authorized Representative)

8. Debarment and Suspension

Debarment and Suspension (Executive Orders 12549 and 12689) – A contract award (see 2 CFR 180.220) must not be made to parties listed on the government-wide exclusions in the System for Award Management (SAM), in accordance

with the OMB guidelines at 2 CFR 180 that implement Executive Orders 12549 (3 CFR Part 1966 Comp. p. 189) and 12689 (3CFR Part 1989 Comp. p. 235), "Debarment and Suspension." SAM Exclusions contains the names of parties debarred, suspended, or otherwise excluded by agencies, as well as parties declared ineligible under statutory or regulatory authority other than Executive Order 12549.

Supplier Partner certifies that Supplier Partner is not currently listed on the government-wide exclusions in SAM, is not debarred, suspended, or otherwise excluded by agencies or declared ineligible under statutory or regulatory authority other than Executive Order 12549. Supplier Partner further agrees to immediately notify the Cooperative and all Members with pending purchases or seeking to purchase from Supplier Partner if Supplier Partner is later listed on the government-wide exclusions in SAM, or is debarred, suspended, or otherwise excluded by agencies or declared ineligible under statutory or regulatory authority other than Executive Order 12549.

Does Respondent agree? TPK

(Initials of Authorized Representative)

9. *Byrd Anti-Lobbying Amendment*

Byrd Anti-Lobbying Amendment (31 USC 1352) – Supplier Partners that apply or bid for an award exceeding one hundred thousand dollars (\$100,000) must file the required certification. Each tier certifies to the tier above that it will not and has not used Federal appropriated funds to pay any person or organization for influencing or attempting to influence an officer or employee of any agency, a member of Congress, officer or employee of Congress, or an employee of a member of Congress in connection with obtaining any Federal contract, grant or any other award covered by 31 USC 1352. Each tier must also disclose any lobbying with non-Federal funds that takes place in connection with obtaining any Federal award. Such disclosures are forwarded from tier to tier up to the non-Federal award. As applicable, Supplier Partner agrees to file all certifications and disclosures required by, and otherwise comply with, the Byrd Anti-Lobbying Amendment (31 USC 1352).

Does Respondent agree? TPK

(Initials of Authorized Representative)

10. *Procurement of Recovered Materials*

For participating agency purchases utilizing Federal funds, Supplier Partner agrees to comply with Section 6002 of the Solid Waste Disposal Act, as amended by the Resource Conservation and Recovery Act where applicable and provide such information and certifications as a participating agency maybe required to confirm estimates and otherwise comply. The requirements of Section 6002 includes procuring only items designated in guidelines of the Environmental Protection Agency (EPA) at 40 CFR Part 247 that contain the highest percentage of recovered materials practicable, consistent with maintaining a satisfactory level of competition, where the purchase price of the item exceeds ten thousand dollars (\$10,000) or the value of the quantity acquired during the preceding fiscal year exceeded ten thousand dollars (\$10,000); procuring solid waste management services in a manner that maximizes energy and resource recovery, and establishing an affirmative procurement program for procurement of recovered materials identified in the EPA guidelines.

Does Respondent agree? TPK

(Initials of Authorized Representative)

11. *Profit as a Separate Element of Price*

For purchases using federal funds in excess of one hundred fifty thousand dollars (\$150,000), a participating agency may be required to negotiate profit as a separate element of the price. See, 2 CFR 200.324(b). When required by a participating

agency, Supplier Partner agrees to provide information and negotiate with the participating agency regarding profit as a separate element of the price for a particular purchase. However, Supplier Partner agrees that the total price, including profit, charged by Supplier Partner to the participating agency shall not exceed the awarded pricing, including any applicable discount, under Supplier Partner's Group Purchasing Agreement.

Does Respondent agree? TPK
(Initials of Authorized Representative)

12. Prohibition on Certain Telecommunications and Video Surveillance Services or Equipment

Vendor agrees that recipients and subrecipients are prohibited from obligating or expending loan or grant funds to procure or obtain, extend or renew a contract to procure or obtain, or enter into a contract (or extend or renew a contract) to procure or obtain equipment, services, or systems that uses covered telecommunications equipment or services as a substantial or essential component of any system, or as critical technology as part of any system from companies described in Public Law 115-232, section 889. Telecommunications or video surveillance equipment or services produced or provided by an entity that the Secretary of Defense, in consultation with the Director of the National Intelligence or the Director of the Federal Bureau of Investigation, reasonably believes to be an entity owned or controlled by, or otherwise connected to, the government of a covered foreign country are also prohibited.

Does Respondent agree? TPK
(Initials of Authorized Representative)

13. Domestic preferences for procurements

For participating agency purchases utilizing Federal funds, Respondent agrees to provide proof, where applicable, that the materials, including but not limited to, iron, aluminum, steel, cement, and other manufactured products are produced in the United States.

"Produced in the United States" means, for iron and steel products, that all manufacturing processes, from the initial melting stage through the application of coatings, occurred in the United States.

"Manufactured products" means items and construction materials composed in whole or in part of non-ferrous metals such as aluminum; plastics and polymer-based products such as polyvinyl chloride pipe; aggregates such as concrete; glass, including optical fiber; and lumber.

Does Respondent agree? TPK
(Initials of Authorized Representative)

14. General Compliance and Cooperation with Members

In addition to the foregoing specific requirements, Vendor agrees, in accepting any purchase order from a Member, it shall make a good faith effort to work with Members to provide such information and to satisfy such requirements as may apply to a particular participating agency purchase or purchases including, but not limited to, applicable recordkeeping and record retention requirements.

Does Respondent agree? TPK
(Initials of Authorized Representative)

15. Applicability to Subcontractors

Offeror agrees that all contracts it awards pursuant to the Contract shall be bound by the foregoing terms and conditions.

Does Respondent agree? TPK

(Initials of Authorized Representative)

By signature below, I certify that the information in this form is true, complete, and accurate and that I am authorized by my company to make this certification and all consents and agreements contained herein.

Authorized signature:

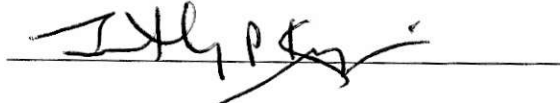

Printed Name:

Timothy P. Kerfien

Company Name:

Haskell Office DBA Haskell Education

Mailing Address:

273 Montgomery Ave. Bala Cynwyd, PA 19004

Job Title:

Customer Support Supervisor/Contract Administrator

PROPOSAL FORM 15: FEMA FUNDING REQUIREMENTS CERTIFICATION FORMS

Please answer the following question. If yes, complete this Proposal Form.

In the event of a contract award, does the Respondent intend to make their products and services available to public agencies utilizing FEMA funds or seeking reimbursement from FEMA?	<input checked="" type="checkbox"/>	Yes
	<input type="checkbox"/>	No

When a participating agency seeks to procure goods and services using funds under a federal grant or contract, specific federal laws, regulations, and requirements may apply in addition to those under state law. This includes, but is not limited to, the procurement standards of the Uniform Administrative Requirements, Cost Principles and Audit Requirements for Federal Awards, 2 CFR 200 (sometimes referred to as the “Uniform Guidance” or “EDGAR” requirements). Additionally, Appendix II to Part 200 authorizes FEMA to require or recommend additional provisions for contracts.

All bidders submitting proposals who desire to work with Members utilizing FEMA funds must complete this FEMA Recommended Contract Provisions Form regarding bidder’s willingness and ability to comply with certain requirements which may be applicable to specific participating agency purchases using FEMA funds. This completed form will be made available to Members for their use while considering their purchasing options when using FEMA grant funds. Members may also require Supplier Partners to enter into ancillary agreements, in addition to the contract’s general terms and conditions, to address the member’s specific contractual needs, including contract requirements for a procurement using federal grants or contracts.

For each of the items below, Bidder should certify bidder’s agreement and ability to comply, where applicable, by having respondents authorized representative complete and initial the applicable lines after each section and sign the acknowledgment at the end of this form. If a Bidder fails to complete any item in this form, CCOG will consider the respondent’s response to be that they are unable or unwilling to comply. A negative response to any of the items may, if applicable, impact the ability of a participating agency to purchase from the Supplier Partner using federal funds.

16. Access to Records

For All Procurements

The Winning Supplier agrees to provide the participating agency, the pass-through entity (if applicable), the FEMA Administrator, the Comptroller General of the United States, or any of their authorized representatives access to any books, documents, papers, and records of the Contractor which are directly pertinent to this contract for the purposes of making audits, examinations, excerpts, and transcriptions.

The Winning Supplier agrees to permit any of the foregoing parties to reproduce by any means whatsoever or to copy excerpts and transcriptions as reasonably needed.

The Winning Supplier agrees to provide the FEMA Administrator or his authorized representatives access to construction or other work sites pertaining to the work being completed under the contract.

Does Respondent agree? TPK

(Initials of Authorized Representative)

For Contracts Entered into After August 1, 2017, Under a Major Disaster or Emergency Declaration

In compliance with section 1225 of the Disaster Recovery Reform Act of 2018, the participating agency, and the Winning Supplier acknowledge and agree that no language in this contract is intended to prohibit audits or internal reviews by the FEMA Administrator or the Comptroller General of the United States.”

Does Respondent agree? TPK
(Initials of Authorized Representative)

17. Changes

FEMA recommends that all contracts include a changes clause that describes how, if at all, changes can be made by either party to alter the method, price, or schedule of the work without breaching the contract. The language of the clause may depend on the nature of the contract and the procured item(s) or service(s). The participating agency should also consult their servicing legal counsel to determine whether and how contract changes are permissible under applicable state, local, or tribal laws or regulations.

Does Respondent agree? TPK
(Initials of Authorized Representative)

18. Use of DHS Seal, Logo, and Flags

The Winning Supplier shall not use the DHS seal(s), logos, crests, or reproductions of flags or likenesses of DHS agency officials without specific FEMA pre-approval. The contractor shall include this provision in any subcontracts.

Does Respondent agree? TPK
(Initials of Authorized Representative)

19. Compliance with Federal Law, Regulations, And Executive Orders and Acknowledgement of Federal Funding

This is an acknowledgement that when FEMA financial assistance is used to fund all or a portion of the participating agency's contract with the Winning Supplier, the Winning Supplier will comply with all applicable federal law, regulations, executive orders, FEMA policies, procedures, and directives.

Does Respondent agree? TPK
(Initials of Authorized Representative)

20. No Obligation by Federal Government

The federal government is not a party to this or any contract resulting from this or future procurements with the participating agencies and is not subject to any obligations or liabilities to the non-federal entity, contractor, or any other party pertaining to any matter resulting from the contract.

Does Respondent agree? TPK
(Initials of Authorized Representative)

21. Program Fraud and False or Fraudulent Statements or Related Acts

The Winning Supplier acknowledges that 31 U.S.C. Chap. 38 (Administrative Remedies for False Claims and Statements) applies to the contractor's actions pertaining to this contract.

Does Respondent agree? TPK
(Initials of Authorized Representative)

22. Affirmative Socioeconomic Steps

If subcontracts are to be let, the Winning Supplier is required to take all necessary steps identified in 2 C.F.R. § 200.321(b)(1)-(5) to ensure that small and minority businesses, women’s business enterprises, and labor surplus area firms are used when possible.

Does Respondent agree? TPK
(Initials of Authorized Representative)

23. License and Delivery of Works Subject to Copyright and Data Rights

The Winning Supplier grants to the participating agency, a paid-up, royalty-free, nonexclusive, irrevocable, worldwide license in data first produced in the performance of this contract to reproduce, publish, or otherwise use, including prepare derivative works, distribute copies to the public, and perform publicly and display publicly such data. For data required by the contract but not first produced in the performance of this contract, the Winning Supplier will identify such data and grant to the participating agency or acquires on its behalf a license of the same scope as for data first produced in the performance of this contract. Data, as used herein, shall include any work subject to copyright under 17 U.S.C. § 102, for example, any written reports or literary works, software and/or source code, music, choreography, pictures or images, graphics, sculptures, videos, motion pictures or other audiovisual works, sound and/or video recordings, and architectural works. Upon or before the completion of this contract, the Winning Supplier will deliver to the participating agency data first produced in the performance of this contract and data required by the contract but not first produced in the performance of this contract in formats acceptable by the (insert name of the non-federal entity).

Does Respondent agree? TPK
(Initials of Authorized Representative)

By signature below, I certify that the information in this form is true, complete, and accurate and that I am authorized by my company to make this certification and all consents and agreements contained herein.

Authorized signature: 

Printed Name: Timothy P. Kerfién
Company Name: Haskell Office DBA Haskell Education
Mailing Address: 273 Montgomery Ave. Bala Cynwyd, PA 19004
Job Title: Customer Support Supervisor/Contract Administrator

PROPOSAL FORM 16: ARIZONA CONTRACTOR REQUIREMENTS

Please answer the following question. If yes, please complete this Proposal Form.

Does the awarded supplier intend to make their products and services available to public agencies in the State of Arizona?	<input checked="" type="checkbox"/> Yes <input type="checkbox"/> No
--	--

In the event the Awarded Supplier desires to pursue public sector opportunities in the State of Arizona, it is important to understand the requirements for working with those public agencies. The documentation and information contained in this proposal form are intended to provide the Respondent with documentation that could be relevant to the providing products & services to public agencies in the State of Arizona. It is the responsibility of the public agency to ensure they are in compliance with local requirements.

AZ Compliance with Federal and State Requirements

Contractor agrees when working on any federally assisted projects with more than \$2,000.00 in labor costs, to comply with all federal and state requirements, as well as Equal Opportunity Employment requirements and all other federal and state laws, statutes, etc. Contractor agrees to post wage rates at the work site and submit a copy of their payroll to the member for their files. Contractor must retain records for three years to allow the federal grantor agency access to these records, upon demand. Contractor also agrees to comply with the Arizona Executive Order 75-5, as amended by Executive Order 99-4.

When working on contracts funded with Federal Grant monies, contractor additionally agrees to comply with the administrative requirements for grants, and cooperative agreements to state, local and federally recognized Indian Tribal Governments.

AZ compliance with workforce requirements

Pursuant to ARS 41-4401, Contractor and subcontractor(s) warrant their compliance with all federal and state immigration laws and regulations that relate to their employees, and compliance with ARS 23-214 subsection A, which states, "... every employer, after hiring an employee, shall verify the employment eligibility of the employee through the E-Verify program"

CCOG reserves the right to cancel or suspend the use of any contract for violations of immigration laws and regulations. CCOG and its members reserve the right to inspect the papers of any contractor or subcontract employee who works under this contract to ensure compliance with the warranty above.

AZ Contractor Employee Work Eligibility

By entering into this contract, contractor agrees and warrants compliance with A.R.S. 41-4401, A.R.S. 23-214, the Federal Immigration and Nationality Act (FINA), and all other Federal immigration laws and regulations. CCOG and/or CCOG members may request verification of compliance from any contractor or sub-contractor performing work under this contract. CCOG and CCOG members reserve the right to confirm compliance. In the event that CCOG or CCOG members suspect or find that any contractor or subcontractor is not in compliance, CCOG may pursue any and all remedies allowed by law, including but not limited to suspension of work, termination of contract, suspension and/or debarment of the contractor. All cost associated with any legal action will be the responsibility of the contractor.

AZ Non-Compliance

All federally assisted contracts to members that exceed \$10,000.00 may be terminated by the federal grantee for noncompliance by contractor. In projects that are not federally funded, Respondent must agree to meet any federal, state or local requirements as necessary. In addition, if compliance with the federal regulations increases the contract costs beyond the agreed upon costs in this solicitation, the additional costs may only apply to the portion of the work paid by the federal grantee.

Registered Sex Offender Restrictions (Arizona)

For work to be performed at an Arizona school, contractor agrees that no employee or employee of a subcontractor who has been adjudicated to be a registered sex offender will perform work at any time when students are present, or reasonably expected to be present. Contractor agrees that a violation of this condition shall be considered a material breach and may result in the cancellation of the purchase order at the CCOG member’s discretion. Contractor must identify any additional costs associated with compliance to this term. If no costs are specified, compliance with this term will be provided at no additional charge.

Offshore Performance of Work Prohibited

Due to security and identity protection concerns, direct services under this contract shall be performed within the borders of the United States.

Terrorism Country Divestments: In accordance with A.R.S. 35-392, CCOG and CCOG members are prohibited from purchasing from a company that is in violation of the Export Administration Act. By entering into the contract, contractor warrants compliance with the Export Administration Act.

The undersigned hereby accepts and agrees to comply with all statutory compliance and notice requirements listed in this document.

Does Respondent agree? TPK
(Initials of Authorized Representative)

Date: 10/30/23

PROPOSAL FORM 17: NEW JERSEY REQUIREMENTS

Please answer the following question. If yes, please complete this Proposal Form.

Does the awarded supplier intend to make their products and services available to public agencies in the State of New Jersey?	<input type="checkbox"/> Yes <input type="checkbox"/> No
---	---

In the event the Awarded Supplier desires to pursue public sector opportunities in the State of New Jersey, it is important to understand the requirements for working with those public agencies. The documentation and information contained in this proposal form are intended to provide the Respondent with documentation that could be relevant to the providing products & services to public agencies in the State of New Jersey. It is the responsibility of the public agency to ensure they are in compliance with local requirements.

New Jersey vendors are also required to comply with the following New Jersey statutes when applicable:

- All anti-discrimination laws, including those contained in N.J.S.A. 10:2-1 through N.J.S.A. 10:2-14, N.J.S.A. 10:5-1, and N.J.S.A. 10:5-31 through 10:5-38.
- Compliance with Prevailing Wage Act, N.J.S.A. 34:11-56.26, for all contracts within the contemplation of the Act.
- Compliance with Public Works Contractor Registration Act, N.J.S.A. 34:11-56.26
- Bid and Performance Security, as required by the applicable municipal or state statutes.

A. Ownership Disclosure Form (N.J.S. 52:25-24.2)

Pursuant to the requirements of P.L. 1999, Chapter 440 effective April 17, 2000 (Local Public Contracts Law), the Respondent shall complete the form attached to these specifications listing the persons owning 10 percent (10%) or more of the firm presenting the proposal.

Company Name: Haskell Office DBA Haskell Education
Street: 273 Montgomery Ave.
City, State, Zip Code: Bala Cynwyd, PA 19004

Complete as appropriate:

I, [Click or tap here to enter text.](#), certify that I am the sole owner of [Click or tap here to enter text.](#), that there are no partners and the business is not incorporated, and the provisions of N.J.S. 52:25-24.2 do not apply.

OR:

I, Alan Robins, a partner in Haskell Office DBA Haskell Education, do hereby certify that the following is a list of all individual partners who own a 10% or greater interest therein. I further certify that if one (1) or more of the partners is itself a corporation or partnership, there is also set forth the names and addresses of the stockholders holding 10% or more of that corporation's stock or the individual partners owning 10% or greater interest in that partnership.

OR:

I, , an authorized representative , a corporation, do hereby certify that the following is a list of the names and addresses of all stockholders in the corporation who own 10% or more of its stock of any class. I further certify that if one (1) or more of such stockholders is itself a corporation or partnership, that there is also set forth the names and addresses of the stockholders holding 10% or more of the corporation's stock or the individual partners owning a 10% or greater interest in that partnership.

(Note: If there are no partners or stockholders owning 10% or more interest, indicate none.)

Name	Address	Interest
Alan Robins	244 Derwen Rd. Merion Station, PA 19066	50%

Type text here

Bruce Robins

2028 Mt. Vernon St. Philadelphia, PA 19130

50%

I further certify that the statements and information contained herein, are complete and correct to the best of my knowledge and belief.

Signature:



Date:

10/27/23

B. Non-Collusion Affidavit

Respondent Name: Timothy P. Kerfien

Street Address: 540 W North St. Apt A

City, State Zip: Geneva NY 14456

State of New York

County of Ontario

I, Timothy P Kerfien of the Geneva in the County of Ontario, State of New York of full age, being duly sworn according to law on my oath depose and say that:

I am the Customer Support Supervisor/Contract Administrator of the firm of Haskell Office DBA Haskell Education the Respondent making the Proposal for the goods, services or public work specified under the Harrison Township Board of Education attached proposal, and that I executed the said proposal with full authority to do so; that said Respondent has not directly or indirectly entered into any agreement, participated in any collusion, or otherwise taken any action in restraint of free, competitive bidding in connection with the above proposal, and that all statements contained in said bid proposal and in this affidavit are true and correct, and made with full knowledge that the Harrison Township Board of Education relies upon the truth of the statements contained in said bid proposal and in the statements contained in this affidavit in awarding the contract for the said goods, services or public work.

I further warrant that no person or selling agency has been employed or retained to solicit or secure such contract upon an agreement or understanding for a commission, percentage, brokerage or contingent fee, except bona fide employees or bona fide established commercial or selling agencies maintained by

Authorized signature:

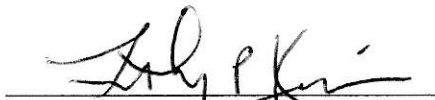

Customer Support Supervisor /

Job Title:

Contract Administrator

Subscribed and sworn before me

this 29th day of October, 2023

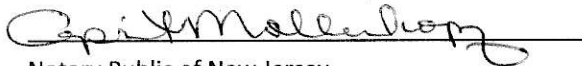

Notary Public of New Jersey

My commission expires Jan 4, 2027

SEAL

APRIL MOLLENKOPF
Notary Public, State of New York
Seneca County No. 01MO 6018166
Commission Expires Jan. 4, 2027

C. Affirmative Action Affidavit (P.L. 1975, C.127)

Company Name: Haskell Office DBA Haskell Education
Street Address: 273 Montgomery Ave.
City, State, Zip Code: Bala Cynwyd, PA 19004

Bid Proposal Certification:

Indicate below your compliance with New Jersey Affirmative Action regulations. Your proposal will be accepted even if you are not in compliance at this time. No contract and/or purchase order may be issued, however, until all Affirmative Action requirements are met.

Required Affirmative Action Evidence:

Procurement, Professional & Service Contracts (Exhibit A)

Suppliers must submit with proposal:

1. A photo copy of their Federal Letter of Affirmative Action Plan Approval
OR
2. A photo copy of their Certificate of Employee Information Report
OR
3. A complete Affirmative Action Employee Information Report (AA302)

Public Work – Over \$50,000 Total Project Cost:

No approved Federal or New Jersey Affirmative Action Plan. We will complete Report Form AA201-A upon receipt from the Harrison Township Board of Education

Approved Federal or New Jersey Plan – certificate enclosed

I further certify that the statements and information contained herein, are complete and correct to the best of my knowledge and belief.

Authorized Signature: 
Title of Signatory: Customer Support Supervisor/Contract Administrator
Date: 10/30/23

P.L. 1995, c. 127 (N.J.A.C. 17:27)

MANDATORY AFFIRMATIVE ACTION LANGUAGE

PROCUREMENT, PROFESSIONAL AND SERVICE CONTRACTS

During the performance of this contract, the contractor agrees as follows:

The contractor or subcontractor, where applicable, will not discriminate against any employee or applicant for employment because of age, race, creed, color, national origin, ancestry, marital status, sex, affectional or sexual orientation. The contractor will take affirmative action to ensure that such applicants are recruited and employed, and that employees are treated during employment, without regard to their age, race, creed, color, national origin, ancestry, marital status, sex, affectional or sexual orientation. Such action shall include, but not be limited to the following: employment, upgrading, demotion, or transfer; recruitment or recruitment

advertising; layoff or termination; rates of pay or other forms of compensation; and selection for training, including apprenticeship. The contractor agrees to post in conspicuous places, available to employees and applicants for employment, notices to be provided by the Public Agency Compliance Officer setting forth provisions of this non-discrimination clause.

The contractor or subcontractor, where applicable will, in all solicitations or advertisement for employees placed by or on behalf of the contractor, state that all qualified applicants will receive consideration for employment without regard to age, race, creed, color, national origin, ancestry, marital status, sex, affectional or sexual orientation.

The contractor or subcontractor, where applicable, will send to each labor union or representative of workers with which it has a collective bargaining agreement or other contract or understanding, a notice, to be provided by the agency contracting officer advising the labor union or workers' representative of the contractor's commitments under this act and shall post copies of the notice in conspicuous places available to employees and applicants for employment.

The contractor or subcontractor, where applicable, agrees to comply with any regulations promulgated by the Treasurer pursuant to P.L. 1975, c. 127, as amended and supplemented from time to time and the Americans with Disabilities Act.

The contractor or subcontractor agrees to attempt in good faith to employ minority and female workers trade consistent with the applicable county employment goal prescribed by N.J.A.C. 17:27-5.2 promulgated by the Treasurer pursuant to P.L. 1975, C.127, as amended and supplemented from time to time or in accordance with a binding determination of the applicable county employment goals determined by the Affirmative

Action Office pursuant to N.J.A.C. 17:27-5.2 promulgated by the Treasurer pursuant to P.L. 1975, C.127, as amended and supplemented from time to time.

The contractor or subcontractor agrees to inform in writing appropriate recruitment agencies in the area, including employment agencies, placement bureaus, colleges, universities, labor unions, that it does not discriminate on the basis of age, creed, color, national origin, ancestry, marital status, sex, affectional or sexual orientation, and that it will discontinue the use of any recruitment agency which engages in direct or indirect discriminatory practices.

The contractor or subcontractor agrees to revise any of its testing procedures, if necessary, to assure that all personnel testing conforms with the principles of job-related testing, as established by the statutes and court decisions of the state of New Jersey and as established by applicable Federal law and applicable Federal court decisions.

The contractor or subcontractor agrees to review all procedures relating to transfer, upgrading, downgrading and lay-off to ensure that all such actions are taken without regard to age, creed, color, national origin, ancestry, marital status, sex, affectional or sexual orientation, and conform with the applicable employment goals, consistent with the statutes and court decisions of the State of New Jersey, and applicable Federal law and applicable Federal court decisions.

The contractor and its subcontractors shall furnish such reports or other documents to the Affirmative Action Office as may be requested by the office from time to time in order to carry out the purposes of these regulations, and public agencies shall furnish such information as may be requested by the Affirmative Action Office for conducting a compliance investigation pursuant to Subchapter 10 of the Administrative Code (NJAC 17:27).

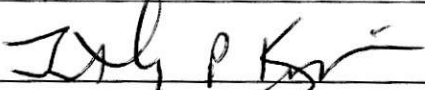

Signature of Procurement Agent

D. C. 271 Political Contribution Disclosure Form

PUBLIC AGENCY INSTRUCTIONS

This page provides guidance to public agencies entering into contracts with business entities that are required to file Political Contribution Disclosure forms with the agency. **It is not intended to be provided to contractors.** What follows are instructions on the use of form local units can provide to contractors that are required to disclose political contributions pursuant to N.J.S.A. 19:44A-20.26 (P.L. 2005, c. 271, s.2). Additional information is available in Local Finance Notice 2006-1 (https://www.nj.gov/dca/divisions/dlgs/resources/lfns_2006.html).

1. The disclosure is required for all contracts in excess of \$17,500 that are **not awarded** pursuant to a “fair and open” process (N.J.S.A. 19:44A-20.7).
2. Due to the potential length of some contractor submissions, the public agency should consider allowing data to be submitted in electronic form (i.e., spreadsheet, pdf file, etc.). Submissions must be kept with the contract documents or in an appropriate computer file and be available for public access. **The form is worded to accept this alternate submission.** The text should be amended if electronic submission will not be allowed.
3. The submission must be **received from the contractor and** on file at least 10 days prior to award of the contract. Resolutions of award should reflect that the disclosure has been received and is on file.
4. The contractor must disclose contributions made to candidate and party committees covering a wide range of public agencies, including all public agencies that have elected officials in the county of the public agency, state legislative positions, and various state entities. The Division of Local Government Services recommends that contractors be provided a list of the affected agencies. This will assist contractors in determining the campaign and political committees of the officials and candidates affected by the disclosure.
 - a) The Division has prepared model disclosure forms for each county. They can be downloaded from the “County PCD Forms” link on the Pay-to-Play web site at https://www.state.nj.us/dca/divisions/dlgs/programs/pay_2_play.html. They will be updated from time-to-time as necessary.
 - b) A public agency using these forms **should edit them to properly reflect the correct legislative district(s)**. As the forms are county-based, **they list all legislative districts** in each county. **Districts that do not represent the public agency should be removed from the lists.**
 - c) Some contractors may find it easier to provide a single list that covers all contributions, regardless of the county. These submissions are appropriate and should be accepted.
 - d) The form may be used “as-is”, subject to edits as described herein.
 - e) The “Contractor Instructions” sheet is intended to be provided with the form. It is recommended that the Instructions and the form be printed on the same piece of paper. The form notes that the Instructions are printed on the back of the form; where that is not the case, the text should be edited accordingly.
 - f) The form is a Word document and can be edited to meet local needs, and posted for download on web sites, used as an e-mail attachment, or provided as a printed document.
5. It is recommended that the contractor also complete a “Stockholder Disclosure Certification.” This will assist the local unit in its obligation to ensure that contractor did not make any prohibited contributions to the committees listed on the Business Entity Disclosure Certification in the 12 months prior to the contract. (See Local Finance Notice 2006-7 for additional information on this obligation) A sample Certification form is part of this package and the instruction to complete it is included in the Contractor Instructions. **NOTE: This section is not applicable to Boards of Education.**

CONTRACTOR INSTRUCTIONS

Business entities (contractors) receiving contracts from a public agency in the state of New Jersey that are NOT awarded pursuant to a “fair and open” process (defined at [N.J.S.A. 19:44A-20.7](#)) are subject to the provisions of P.L. 2005, c. 271, s.2 ([N.J.S.A. 19:44A-20.26](#)). This law provides that 10 days prior to the award of such a contract, the contractor shall disclose contributions to:

- any State, county, or municipal committee of a political party
- any legislative leadership committee*
- any continuing political committee (a.k.a., political action committee)
- any candidate committee of a candidate for, or holder of, an elective office:
 - of the public entity awarding the contract
 - of that county in which that public entity is located
 - of another public entity within that county
 - or of a legislative district in which that public entity is located or, when the public entity is a county, of any legislative district which includes all or part of the county. The disclosure must list reportable contributions to any of the committees that exceed \$300 per election cycle that were made during the 12 months prior to award of the contract. See [N.J.S.A. 19:44A-8](#) and [19:44A-16](#) for more details on reportable contributions.

[N.J.S.A. 19:44A-20.26](#) itemizes the parties from whom contributions must be disclosed when a business entity is not a natural person. This includes the following:

- individuals with an “interest” ownership or control of more than 10% of the profits or assets of a business entity or 10% of the stock in the case of a business entity that is a corporation for profit
- all principals, partners, officers, or directors of the business entity or their spouses
- any subsidiaries directly or indirectly controlled by the business entity
- IRS Code Section 527 New Jersey based organizations, directly or indirectly controlled by the business entity and filing as continuing political committees, (PACs). When the business entity is a natural person, “a contribution by that person’s spouse or child, residing therewith, shall be deemed to be a contribution by the business entity.” [[N.J.S.A. 19:44A-20.26\(b\)](#)] The contributor must be listed on the disclosure. Any business entity that fails to comply with the disclosure provisions shall be subject to a fine imposed by ELEC in an amount to be determined by the Commission which may be based upon the amount that the business entity failed to report. The enclosed list of agencies is provided to assist the contractor in identifying those public agencies whose elected official and/or candidate campaign committees are affected by the disclosure requirement. It is the contractor’s responsibility to identify the specific committees to which contributions may have been made and need to be disclosed. The disclosed information may exceed the minimum requirement. The enclosed form, a content-consistent facsimile, or an electronic data file containing the required details (along with a signed cover sheet) may be used as the contractor’s submission and is disclosable to the public under the Open Public Records Act. The contractor must also complete the attached Stockholder Disclosure Certification. This will assist the agency in meeting its obligations under the law.

NOTE: This section does not apply to Board of Education contracts.

¹ [N.J.S.A. 19:44A-3\(s\)](#): “The term “legislative leadership committee” means a committee established, authorized to be established, or designated by the President of the Senate, the Minority Leader of the Senate, the Speaker of the General Assembly or the Minority Leader of the General Assembly pursuant to section 16 of P.L.1993, c.65 ([C.19:44A-10.1](#)) for the purpose of receiving contributions and making expenditures.”

C. 271 POLITICAL CONTRIBUTION DISCLOSURE FORM

Required Pursuant To [N.J.S.A. 19:44A-20.26](#)

This form or its permitted facsimile must be submitted to the local unit no later than 10 days prior to the award of the contract.

Part I – Vendor Information

Vendor Name:	Haskell Office DBA Haskell Education		
Address:	273 Montgomery Ave.		
City:	Bala Cynwyd	State:PA	Zip:19004

The undersigned being authorized to certify, hereby certifies that the submission provided herein represents compliance with the provisions of N.J.S.A. 19:44A-20.26 and as represented by the Instructions accompanying this form.



Signature of Vendor

Timothy P. Kerfien

Printed Name

Customer Support Supervisor
/Contract Administrator

Title

Part II – Contribution Disclosure

Disclosure requirement: Pursuant to N.J.S.A. 19:44A-20.26 this disclosure must include all reportable political contributions (more than \$300 per election cycle) over the 12 months prior to submission to the committees of the government entities listed on the form provided by the local unit.

Check here if disclosure is provided in electronic form.

Contributor Name	Recipient Name	Date	Dollar Amount
NONE			\$

Check here if the information is continued on subsequent page(s)

Continuation Page

C. 271 POLITICAL CONTRIBUTION DISCLOSURE FORM

Required Pursuant To N.J.S.A. 19:44A-20.26

Page ___ of _____

Vendor Name:

Contributor Name	Recipient Name	Date	Dollar Amount
Contributor Name	Recipient Name	Date	Amount
Contributor Name	Recipient Name	Date	Amount
Contributor Name	Recipient Name	Date	Amount
Contributor Name	Recipient Name	Date	Amount
Contributor Name	Recipient Name	Date	Amount
Contributor Name	Recipient Name	Date	Amount
Contributor Name	Recipient Name	Date	Amount
Contributor Name	Recipient Name	Date	Amount
Contributor Name	Recipient Name	Date	Amount
Contributor Name	Recipient Name	Date	Amount
Contributor Name	Recipient Name	Date	Amount
Contributor Name	Recipient Name	Date	Amount
Contributor Name	Recipient Name	Date	Amount
Contributor Name	Recipient Name	Date	Amount
Contributor Name	Recipient Name	Date	Amount
Contributor Name	Recipient Name	Date	Amount
Contributor Name	Recipient Name	Date	Amount
Contributor Name	Recipient Name	Date	Amount
Contributor Name	Recipient Name	Date	Amount
Contributor Name	Recipient Name	Date	Amount
Contributor Name	Recipient Name	Date	Amount
Contributor Name	Recipient Name	Date	Amount
Contributor Name	Recipient Name	Date	Amount
Contributor Name	Recipient Name	Date	Amount
Contributor Name	Recipient Name	Date	Amount
Contributor Name	Recipient Name	Date	Amount
Contributor Name	Recipient Name	Date	Amount
Contributor Name	Recipient Name	Date	Amount
Contributor Name	Recipient Name	Date	Amount
Contributor Name	Recipient Name	Date	Amount
Contributor Name	Recipient Name	Date	\$Amount
Contributor Name	Recipient Name	Date	\$Amount
Contributor Name	Recipient Name	Date	\$Amount
Contributor Name	Recipient Name	Date	\$Amount
Contributor Name	Recipient Name	Date	\$Amount
Contributor Name	Recipient Name	Date	\$Amount
Contributor Name	Recipient Name	Date	\$Amount

Check here if the information is continued on subsequent page(s)

List of Agencies with Elected Officials Required for Political Contribution Disclosure

N.J.S.A. 19:44A-20.26

County Name:

State: Governor, and Legislative Leadership Committees

Legislative District #s:

State Senator and two members of the General Assembly per district.

County:

Freeholders	County Clerk	Sheriff
{County Executive}	Surrogate	

Municipalities (Mayor and members of governing body, regardless of title):

USERS SHOULD CREATE THEIR OWN FORM, OR DOWNLOAD FROM WWW.NJ.GOV/DCA/LGS/P2P A COUNTY-BASED, CUSTOMIZABLE FORM.

E. Stockholder Disclosure Certification

Name of Business: Haskell Office LLC DBA Haskell Education **We are not publicly held. There are no stockholders.**

I certify that the list below contains the names and home addresses of all stockholders holding 10% or more of the issued and outstanding stock of the undersigned.

OR

I certify that no one stockholder owns 10% or more of the issued and outstanding stock of the undersigned.

Check the box that represents the type of business organization:

- Partnership
- Corporation
- Sole Proprietorship
- Limited Partnership
- Limited Liability Corporation
- Limited Liability Partnership
- Subchapter S Corporation

Sign and notarize the form below, and, if necessary, complete the stockholder list below.

Stockholders:

Name: Stockholder Name	Name: Stockholder Name
Home Address: Home Address	Home Address: Home Address
Name: Stockholder Name	Name: Stockholder Name

Home Address:
Home Address

Home Address:
Home Address

Name: Stockholder Name

Name: Stockholder Name

Home Address:
Home Address

Home Address:
Home Address

Subscribed and sworn before me this ___ day of _____,
_____, 2__.

(Affiant)

(Notary Public)

(Print name & title of affiant)

My Commission expires:

(Corporate Seal)

PROPOSAL FORM 18: GENERAL TERMS AND CONDITIONS ACCEPTANCE FORM

Check one of the following responses to the General Terms and Conditions in this solicitation, including the Master Agreement:

We take no exceptions/deviations to the general terms and conditions.
(Note: If none are listed below, it is understood that no exceptions/deviations are taken.)

We take the following exceptions/deviations to the general terms and conditions. All exceptions/deviations must be clearly explained. Reference the corresponding general terms and conditions that you are taking exceptions/deviations to. Clearly state if you are adding additions terms and conditions to the general terms and conditions. Provide details on your exceptions/deviations below:

[Click or tap here to enter text.](#)

(Note: Unacceptable exceptions shall remove your proposal from consideration for award. CCOG shall be the sole judge on the acceptance of exceptions/deviations and the decision shall be final.)

PROPOSAL FORM 19: EQUALIS GROUP ADMINISTRATION AGREEMENT DECLARATION

Attachment A - Sample Administration Agreement of this solicitation is for reference only. Contracting with Equalis Group and the Winning Supplier will occur after contract award.

Execution of the Administration Agreement is required for the Master Agreement to be administered by Equalis Group. **Attachment A - Sample Administration Agreement** defines i) the roles and responsibilities of both parties relating to marketing and selling the Program to current and prospective Members, and ii) the financial terms between Equalis Group and Winning Supplier.

Redlined copies of this agreement should not be submitted with the response.

Should a Respondent be recommended for award, this agreement will be negotiated and executed between Equalis Group and the Respondent. Respondents must select one of the following options for submitting their response.

- Respondent agrees to all terms and conditions in **Attachment A - Sample Administration Agreement**.
- Respondent wishes to negotiate directly with Equalis Group on terms and conditions in the Sample Administration Agreement. Negotiations will commence after CCOG has completed contract award.

PROPOSAL FORM 20: MASTER AGREEMENT SIGNATURE FORM

RESPONDENTS MUST SUBMIT THIS FORM COMPLETED AND SIGNED WITH THEIR RESPONSE TO BE CONSIDERED FOR AWARD.

The undersigned hereby proposes and agrees to furnish Products & Services in strict compliance with the terms, specifications, and conditions contained within this RFP and the Master Agreement at the prices proposed within the submitted proposal unless noted in writing. The undersigned further certifies that he/she is an officer of the company and has authority to negotiate and bind the company named below and has not prepared this proposal in collusion with any other Respondent and that the contents of this proposal as to prices, terms or conditions of said proposal have not been communicated by the undersigned nor by any employee or agent to any person engaged in this type of business prior to the official opening of this proposal.

Company Name Haskell Office DBA Haskell Education
Address 273 Montgomery Ave.
City/State/Zip Bala Cynwyd, PA 19004
Phone Number 616-278-1010
Email Address tkerfien@haskelloffice.com
Printed Name Timothy P. Kerfien
Job Title Customer Support Supervisor / Contract Administrator

Authorized Signature 

Initial Term of the Master Agreement

Contract Effective Date: January 1, 2024
Contract Expiration Date: December 31, 2027
Contract Number: _____

(Note: Contract Number will be applied prior to CCOG and Equalis Group countersigning.)

The Cooperative Council of Governments, Inc.
6001 Cochran Road, Suite 333
Cleveland, Ohio 44139

Equalis Group, LLC.
5550 Granite Parkway, Suite 298
Plano, Texas 75024

By: _____
Name: Franklyn A. Corlett
As: CCOG Board President
Date: _____

By: _____
Name: Eric Merkle
As: EVP, Procurement & Operations
Date: _____

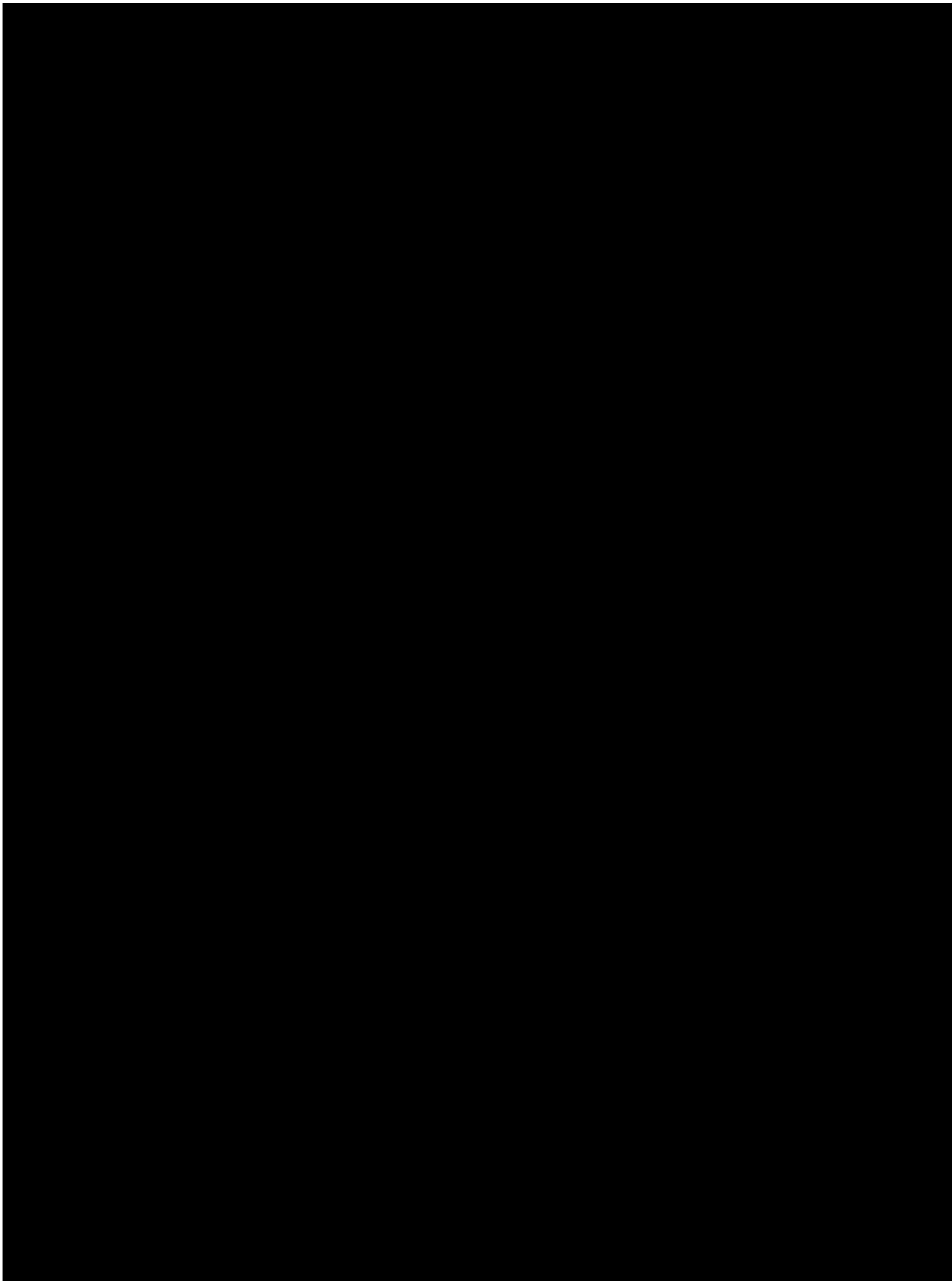

NEW YORK
LONDON
SINGAPORE
PHILADELPHIA
CHICAGO
WASHINGTON, DC
SAN FRANCISCO
SILICON VALLEY
SAN DIEGO
LOS ANGELES
BOSTON
HOUSTON
DALLAS
FORT WORTH
AUSTIN

DuaneMorris®

FIRM and AFFILIATE OFFICES

DAVID J. WOLFSOHN
DIRECT DIAL: +1 215 979 1866
PERSONAL FAX: +1 215 979 1020
E-MAIL: DWolfsohn@duanemorris.com

www.duanemorris.com

HANOI
HO CHI MINH CITY
SHANGHAI
ATLANTA
BALTIMORE
WILMINGTON
MIAMI
BOCA RATON
PITTSBURGH
NEWARK
LAS VEGAS
CHERRY HILL
LAKE TAHOE
MYANMAR

ALLIANCES IN MEXICO

October 13, 2023

VIA E-MAIL

The Cooperative Council of Governments
On Behalf of Equalis Group
6001 Cochran Road, Ste 333
Ref: RFP# COG-2152
Cleveland, OH 44139

Re: Haskell Office LLC

To whom it may concern,

I understand that your office has inquired about certain litigation filed in June 2021 by Haskell Office LLC Education against MooreCo, Inc., No. 2:21-cv-02533-CFK, in the United States District Court for the Eastern District of Pennsylvania. I represented Haskell in the district court litigation. The case was filed by Haskell against MooreCo because of MooreCo's infringement of Haskell's design of its whiteboard. We decided to end the litigation in August 2022. Accordingly, Haskell's claims were dismissed as were Mooreco's counterclaims. We intend to continue to vigorously monitor competitors for infringement of our intellectual property.

Please feel free to contact me if you have any questions.

Very truly yours,

DUANE MORRIS LLP

/s David J. Wolfsohn

David J. Wolfsohn
Partner

DJW:aw

Office of General Services
October 13, 2023
Page 2

cc: Bruce Robins



Attachment 1.3.3 Dealers/Resellers

NAME	ADDRESS1	CITY	STATE	ZIP	TELEPHONE_NO
360 OFFICE OUTFITTERS, INC.	8385 IRIS DRIVE	BROWNSBURG	IN	46112	317-456-4970
A&A MODULAR	100 TAINTER ST	WORCHESTER	MA	1610	508-410-0573
A.J. GRACK BUSINESS INTERIORS	3364 WEST 26TH STREET	ERIE	PA	16506	
ABERDEEN AREA INDIAN HEALTH SRVC	DIV OF FINANCIAL MGT-FED BLDG	ABERDEEN	SD	57401	(605) 867-3065
ABUNDANCE HOUSE FOUNDATION	CO FORWARDING AGENT	GRAND RAPIDS	MI	49523	
ACCOUNTS PAYABLE DEPARTMENT	EAST BLDG RM 1501	NEW YORK	NY	10065	212-650-3812
ACTION BUSINESS INTERIORS	39-B ALPHA PARK	HIGHLAND HTS.	OH	44143	
ADAMS CHRISTIAN SCHOOL	5539 BYRON CENTER AVE	WYOMING	MI	49519	
ADVANCED SPECIAL TOOLS	320 CLARK ROAD	BATTLE CREEK	MI	49037	269-962-9697
Alfred Williams & Co.	1050 Shop Road	Columbia	SC	29201	803-767-4225
ALFRED WILLIAMS & COMPANY	410 S SALISBURY STREET	RALEIGH	NC	27601	(919) 832-9570
ALLIED EQUIPMENT COMPANY, INC.	9 PRINCESS RD #E	LAWRENCEVILLE	NJ	08648	609-512-7236
AMERICAN INTERIORS	302 SOUTH BYRNE ROAD	TOLEDO	OH	43615	248-295-7271
AMERICAN MEDICAL CLINIC	6378 FOURTEEN MILE ROAD	WARREN	MI	48092	248-632-0814
ARRINGTON COMMERCIAL INTERIORS	1724 VIRGINIA BEACH BLVD	VIRGINIA BEACH	VA	23454	(757) 428-7898
ART WERKSMAN ASSOCIATES	6013 MISTY RIDGE LANE	CICERO	NY	13039	315-288-5212
AT EQUIPMENT SALES CORPORATION	130 BROOK STREET	SCARSDALE	NY	10583	(914) 472-7222
ATD AMERICAN	135 GREENWOOD AVENUE	WYNCOTE	PA	19095-1396	215-576-1000

AUTOLIV	1320 PACIFIC	AUBURN HILLS	MI	48326	
A-Z OFFICE RESOURCE	781A AIRWAYS BLVD	JACKSON	MI	38301	
A-Z OFFICE RESOURCE INC	3014 OWEN DRIVE	ANTIOCH	TN	37013	615-471-5746
BALKAN PLUMBING	130-01 JAMACIA AVE	RICHMOND HILL	NY	11418	
BARROWS	1302 ROCKLAND AVE NW	ROANOKE	VA	24012-3838	540-362-5700
Barry X Ball Studio	97 Grand Street	Brooklyn	NY	11249	
BEACH & BEACH ASSESSING	9751	STANWOOD	MI	49346	213-250-2986
BECKS HYBRID	6767 EAST 276TH STREET	ATLANTA	IN	46031	
BELL OFFICE FURNITURE	333 ADAMS STREET	BEDFORD HILLS	NY	10507	914-242-7474
BETHLEHEM AREA SCHOOL DISTRICT	250 E. FAIRVIEW STREET	BETHLEHEM	PA	18018	610-653-7446
B-I-OFFICE FURNITURE	61-65 METROPOLITAN AVENUE	MIDDLE VILLAGE	NY	11379	718-417-0500
BKM	340 WOODMONT RD	MILLFORD	CT	60460	(203) 874-7754
BKM OF TEXAS	9655 CLIFFORD DR	DALLAS	TX	75220	214-902-7200
BRADFORD SYSTEMS	430 COUNTRY CLUB DRIVE	BENSENVILLE	IL	60106	
BRAME SCHOOL PRODUCTS	949 WASHINGTON STREET	DURHAM	NC	27701	919-683-1331
BRIAN KERR	117 NORTH MAIN STREET	ELIZABETHTOWN	KY	42701	
Brighton Gardens of West Orange	220 Pleasant Valley Way	West Orange	NJ	7052	
BRODOVSKY ENTERPRISES	3816 BINZ-ENGLEMAN ROAD	SAN ANTONIO	TX	78219	210-386-6959
BUSINESS ENVIRONMENTS	5611 E MORGAN AVE	EVANSVILLE	IN	47715	(812) 474-4260
BUSINESS EQUIPMENT COMPANY	PO BOX 1385	SPRINGFIELD	OH	45501	
BUSINESS FURNITURE	6102 VICTORY WAY	INDIANAPOLIS	IN	46278	317-216-1606
BUSINESS INTERIORS BY STAPLES	PO BOX 102422	COLUMBIA	SC	29224	
CAMERON PARISH LIBRARY	10200 GULF HIGHWAY	LAKE CHARLES	LA	70607	337-598-5950
CAMERON PARISH LIBRARY	501 MARSHALL ST.	CAMERON	LA	70631	337-775-5421
CARMAX # 7284	2353 GALLATIN PIKE N.	MADISON	TN	37115-2007	615-855-2202
CAROLINA TRAINING ASSOCIATES	3623 LATROBE SUITE 120	CHARLOTTE	NC	28211	(704) 366-6309
CBI CHARLOTTE	4020 YANCEY ROAD	CHARLOTTE	NC	28217	919-991-1077

CG CONCEPTS	2331 FORTUNE DRIVE	LEXINGTON	KY	40509	
Charleston County School District	Charleston County SD Warehouse	North Charleston	SC	29405	

NAME ADDRESS1 CITY STATE ZIP TELEPHONE_NO

CHIEF FINANCE DIVISION	VA REGIONAL OFFICE	PITTSBURGH	PA	15222	412-365-5437
CHRISTIANA ELEMENTARY	4701 SHELBYVILLE PIKE	CHRISTIANA	TN	37037	615-896-0614
CI SELECT	11840 WESTLINE INDUSTRIAL DRIVE	MARYLAND HEIGHTS	MO	63146	314-909-1990
CI SELECT WAREHOUSE	3667 CORPORATE TRAIL DRIVE	EARTH CITY	MO	63045	314-426-5622
CINDY DOWNEY	16388 HELICOPTER DRIVE	BROOKSVILLE	FL	34604	352-797-5813 X 7421
CLAIR DAVID OFFICE FURNITURE & DESIGN	6540 W. CENTRAL AVENUE	TOLEDO	OH	43617	419-843-2300
CLUB NOVA	103 #D WEST MAIN STREET	CARRBORO	NC	27510	919-968-6682
CMF BUSINESS SUPPLIES	3622 KENNEDY ROAD	SOUTH PLAINFIELD	NJ	7080	908-753-0800
CMF BUSINESS SUPPLIES, INC	3622 KENNEDY RD	SO PLAINFIELD	NJ	7080	908-753-0800
COMMERCIAL ENVIRONMENTS	505 CARDEN JENNINGS LANE	KNOXVILLE	TN	37932	865-671-9700
COMMERCIAL ENVIRONMENTS, INC.	505 CARDEN JENNINGS LANE	KNOXVILLE	TN	37932	865-671-9700
COMMONWEALTH OF PA	PO INVOICE	HARRISBURG	PA	17106	(610) 871-4138
COMPLEX MANUFACTURING	3 WHYTE STREET	UNION BRIDGE	MD	21791	410-775-1441
COMPUTER COMFORTS	2224 E RANDOLL MILLS ROAD	ARLINGTON	TX	76011	
CONCEPTS SCHOOL AND OFFICE	27480 COLT COURT	TEMECULA	CA	92590	951-296-5591
CONCORDIA UNIVERSITY CHICAGO	7400 AUGUSTA ST	RIVER FOREST	IL	60305	708-771-8300
CONNEAUT SCHOOL DISTRICT	219 WEST SCHOOL DRIVE	LINESVILLE	PA	16424	814-683-5417
CONSTRUCTION MANAGEMENT	809 QUAIL STREET	LAKWOOD	CO	80215	
CONSUMER OFFICE FURNITURE	PINNACLE DESIGN	SAGINAW	MI	48603	(989) 790-6699
CONTEMPORARY GALLERIES	PO BOX 2829	CHARLESTON	WV	25330	304-344-1231
CONTINENTAL OFFICE ENVIRONMENTS	2601 SILVER DR	COLUMBUS	OH	43211	(614) 262-8088
CONTRACT CONNECTIONS INC	9125-E WHISKEY BOTTOM RD	LAUREL	MD	20723	(301) 937-7900
CONTRACT FURNISHINGS	114 N ST FRANCIS	WICHITA	KS	67202	316-267-5763
CONTRACT SOURCE INC	2 CORPORATION CENTER	BROADVIEW HTS	OH	44147	800-733-0027

COPPERFIELD CHIMNEY	4753 14 MILE RD	ROCKFORD	MI	49341	616-874-9322
CORPORATE CONCEPTS	2412 MAIN STREET	COLUMBIA	SC	29201-1948	
CORPORATE CONCEPTS	1308 COOK STREET	COLUMBIA	SC	29203	803-348-6237
CORPORATE ENVIRONMENTS	605 EAST BROAD ST	BETHLEHEM	PA	18018-6396	610-974-7990
COS BUSINESS PRODUCTS & INTERIORS	1548 RIVERSIDE DR	CHATTANOOGA	TN	37406	(423) 624-0011
COYOTE SCHOOL FURNISHINGS	32903 N MILDRED LANE	SAN TAN VALLEY	AZ	85142	(480) 227-0800
CREATIVE LIBRARY CONCEPTS	525 BOULEVARD	KENILWORTH	NJ	07033-1611	(908) 276-9200
CREATIVE OFFICE DESIGNS, INC	25600 WOODWARD AVE	ROYAL OAK	MI	48067	248-399-8107
CREATIVE STUDIO PROMOTIONS	25 JEFFERSON SE SUITE 102	GRAND RAPIDS	MI	49503	616-485-0065
CRETE-MONEE CMTY SCHOOL DISTRICT 201U	1400 S. SANGAMOND	CRETE	IL	60417	
CULVER-NEWLIN	520 E RINCON STREET	CORONA	CA	92879	
CWC	I-85 AT SPECIAL MONEY ROAD	ATLANTA	GA	30340	
CWC OFFICE FURNISHINGS	4343 NE EXPRESSWAY	ATLANTA	GA	30340	800-292-8220
CYNTHIA MARIE KEENAN	3004 WOODSBORO DR	GRAND RAPIDS	MI	49525	
DAVID LANTING	6935 EDGEVIEW AVE SW	BYRON CENTER	MI	49315	616-231-3086
DAVID PRINCE	80 WOODLAKE RD	KINCHELOE	MI	49788	
DCSD INNOVATION & DESIGN CENTER	985 S PLUM CREEK BLVD	CASTLE ROCK	CO	80104	303-387-0608
DELANEY & ASSOCIATES, INC.	20120 ROUTE 19	CRANBERRY TOWNSHIP	PA	16066	
DELVE INTERIORS	050 WILLOWSPRINGS LANE	BURLINGTON	NC	27215	704-817-1109
DEMCO					
DENSO MANUFACTURING	ONE DENSO ROAD	BATTLE CREEK	MI	49037-7356	
DEVELOPMENT OFFICE	10 GRAND ARMY PLAZA	BROOKLYN	NY	11238	718-230-2100
DEW-EL L.L.C.	10841 PAW PAW DRIVE	HOLLAND	MI	49424	(616) 396-6554
Dimation Inc.	505 West Travelers Trail	Burnsville	MN	55337	952-374-5624
DIVISION OF GAMING ENFORCEMENT	1300 ATLANTIC AVE	ATLANTIC CITY	NJ	8401	609-441-7557
DIVISION OF GAMING ENFORCEMENT	140 EAST FRONT STREET	TRENTON	NJ	8625	609-441-7551
DNI VENTURES, INC.	4208 E RIVER RD	DAYTON	OH	45439	937-294-1613

NATIONAL DEALER

DOUGLAS COUNTY SCHOOL DISTRICT	985 S PLUM CREEK BLVD	CASTLE ROCK	CO	80104	303-387-0608
DOUGLAS WAYNE RUCKER	6569 JASONVILLE FARMS BLVD	CALEDONIA	MI	49316	269-832-0349
DR CONSULTANTS	21 CHESTNUT STREET	WESTFIELD	MA	1085	413-348-3622
DREAM TEAM INSTALATIONS	2 EATON ST	HAMPTON	VA	23661	757-565-6060

NAME ADDRESS1 CITY STATE ZIP TELEPHONE_NO

DURHAM ELEMENTARY	654 HALLOWELL ROAD	DURHAM	ME	4222	
EDI / ERGOSPACE DESIGN INC	OFFICE FURNITURE GROUP	HILLSBOROUGH	NJ	08844-1909	(908) 874-4074
EDMARKET SHOW	WILL ADVISE		IL		
EDUCATORS DEPOT	7903 LOOP 540	BEASLEY	TX	77417	
ELB GLOBAL			CA		
ELEMENTS IV INTERIORS	3680 WYSE RD	DAYTON	OH	45414	937-918-1000
ELLIOTT INTERIORS	13 DUGGAN LANE	GOSHEN	NY	19024	845-321-0219
ENCORE CONSULTING LLC	1209 EL RADO STREET	CORAL GABLES	FL	33134	954-559-3117
ENVIRON CONTRACT	ATTN: PAUL LUCAS AND MIKE CEBULAK	PITTSBURGH	PA	15218	412-253-6549
ERNIE MORRIS			FL		
EVERITT MIDDLE SCHOOL	3900 KIPLING STREET	WHEAT RIDGE	CO	80033	
EXEPTIONAL INSTALLATIONS	C/O SPRINGFIELD JR - SR HIGH	SULLIVAN	OH	44880	
EXPERT OFFICE LLC (EMERSON)	2222 ROBERTSON DRIVE	RICHLAND	WA	99354	
FAISON OFFICE PRODUCTS	3206 REHOBETH CHURCH ROAD	GREENSBORO	NC	27406	336-856-0100
FEDERAL BUREAU OF PRISONS	UNITED STATES PENITENTIARY	ATLANTA	GA	30315	(404) 635-5628
FEIGUS OFFICE FURNITURE	2604 ATLANTIC AVENUE	WALL	NJ	7719	732-780-6665 X 12
FENS ASSOCIATES, LLC	PO BOX 186	GROVELAND	MA	1834	
FLINT ENERGY	3051 CITY VIEW DRIVE	MORGANTOWN	WV	26501	304-292-0041
FORECAST			MI		
FOREST ROAD SCHOOL	16 FOREST AVENUE	VALLEY STREAM	NY	11581-6134	
FORMS AND SUPPLY	1314 E FIFTH ST	LUMBERTON	NC	28358	800-286-3458 X3505
FORSYTH COUNTY BOARD OF EDUCATION	1120 DAHLONEGA HWY	CUMMING	GA	30040	

NATIONAL DEALER

FRANK COONEY COMPANY	1226 N MICHAEL DR	WOOD DALE	IL	60191	(630) 694-8800
G & G BUILDERS INC	500 CORPORATE CENTRE DRIVE	SCOTT DEPOT	WV	25560	(304) 757-9196
G & M BUSINESS INTERIORS	1099 W. LA CADENA	RIVERSIDE	CA	92501	800-686-6583
GBI	320 SEVEN SPRINGS WAY	BRENTWOOD	TN	37027	615-425-5257
GDY INSTALLATIONS	302 ARCO DR.	TOLEDO	OH	43607	
GEFE	6050 SHADOW HILLS ROAD	LAS CRUCES	NM	88012-9539	
GIBRALTAR	421 CEMENTENNIAL ST	ZEELAND	MI	49464	616-748-4857
GOSHEN COLLEGE	1700 SOUTH MAIN STREET	GOSHEN	IN	46526	(574) 535-7316
GOVERNMENT & EDUCATIONAL FURNISHINGS ENT	5784 IRISH PAT MURPHY DRIVE	PARKER	CO	80134	575-312-2177
GREAT LAKES FURNITURE SUPPLY, INC.	687 COMMERCE COURT	HOLLAND	MI	49424	
GREATER SOUTHERN TIER BOCES	9579 VOCATIONAL DRIVE	PAINTED POST	NY	14870	607-739-3581
GREGORY CLARIN	6556 GRAN VIA DR	ROCKFORD	MI	49341	616-915-2106
GTK COMPANY	257 CARROLL STREET	BROOKLY	NY	11231-4901	718-237-0033
GUERNSEY, INC.	45070 OLD OX ROAD	DULLES	VA	20166	703-501-4043
GULFCOAST FURNITURE INSTALLATION	4731 TRANSPORT DR	TAMPA	FL	33605	239-940-3440
HAPPY'S OF MADISONVILLE INC.	62 SOUTH MAIN STREET	MADISONVILLE	KY	42431	270-821-6300
HARDWARE DISTIRBUTORS, INC.	PO BOX 16847	GREENSBORO	NC	27406	336-379-0112
HARDWARE DISTRIBUTERS INC	216 INDUSTRIAL AVENUE	GREENSBORO	NC	27406	336-379-0112
HARRIS OFFICE FURNITURE CO.	520 KIMBALL AVE, NE	ROANOKE	VA	24016	
HEART OF AMERICA FOUNDATION	2270 BEAVER ROAD	LANDOVER	MD	20785	202-347-6278
HENRICKSEN	1101 WEST THORNDALE AVE	ITASCA	IL	60143	630-250-9090
HENRY B. GONZALES CONVENTION CENTER	200 EAST MARKET STREET	SAN ANTONIO	TX	78205	
HERALD OFFICE SOLUTIONS	3250 TILE DRIVE	CHARLESTON	SC	29405	843-556-1007
HERCULES & HERCULES	19055 W. DAVISON	DETROIT	MI	48223	855-933-6669
HERTZ FURNITURE	95 MCKEE DRIVE	MAHWAH	NJ	7430	800-526-4677 X 1109
HILLYARD ENTERPRISES	571 GORDON INDUSTRIAL CT	BYRON CENTER	MI	49315	616-206-4784
HN-C0021	CENTRAL RECEIVING	NEW YORK	NY	10065	

HOLLAND PATENT CENTRAL SCHOOL	9601 MAIN STREET	HOLLAND PATENT	NY	13354	
HOUSTON COMMUNITY COLLEGE	5601 WEST LOOP SOUTH	HOUSTON	TX	77081	713-718-7735
HUDSON BAY ENVIRONMENTS	4707 32ND PL	LONG ISLAND CITY	NY	11101-2409	
HUDSON OFFICE SOLUTIONS	900 WEST NATIONAL HWY	WASHINGTON	IN	47501	812-254-0495
HUNTER COLLEGE	126 EAST 69TH STREET	NEW YORK	NY	10065	212-650-3812
HUNTER COLLEGE	695 PARK AVENUE	NEW YORK	NY	10065	
INDECO SALES, INC.	805 E 4TH AVE	BELTON	TX	76513	1-800-692-4256

NAME

ADDRESS1

CITY

STATE

ZIP

TELEPHONE_NO

INDEPENDENCE BUSINESS SUPPLY	4550 HINCKLEY PKWY	CLEVELAND	OH	44109	216-398-8880
INDOFF INC	PO BOX 46900	ST LOUIS	MO	63146-4206	
INDOFF, INCORPORATED	P.O. BOX 46900	ST. LOUIS	MO	63146-4206	620-724-4670
INFINITY MATH, SCIENCE, & TECHNOLOGY HS	3120 SOUTH KOSTNER AVE	CHICAGO	IL	60623	773-525-4228
INGHAM ASSOCIATES INC,	3680 BUFFALO ROAD	ROCHESTER	NY	14624	585-303-4684
INNOVATIVE OFFICE SOLUTIONS, INC.	8016 INDUSTRIAL DR	MARIA STEIN	OH	45860	419-925-5433
INTEGRITY OFFICE PRODUCTS	D/B/A LOY'S OFFICE SUPPLIES	LAGRANGE	GA	30240	706-884-1723
INTER OFFICE WORKSPACE FURNITURE	505 NORTH BROADWAY	FARGO	ND	58102	
INTERGRATED	125 STATE STREET	MOONACHIE	NJ	7074	201-994-8718
INTERIOR POSSIBILITIES OFFICE FURNITURE	55 VERMEER DRIVE	LANGHORNE	PA	19053	215-741-1727
INTERIOR WORKPLACE SOLLUTIONS LLC	6765 AMBASSADOR DRIVE	ALLENTOWN	PA	18106-9510	610-391-0733
INTEROFFICE WORKSPACE FURN	505 NORTH BROADWAY	FARGO	ND	58102	701-232-3013
ISPACE FURNITURE	811 GLENWOOD AVENUE	MINNEAPOLIS	MN	55405	612-278-9217
J & S EQUIPMENT CO.	1222 E ARAPAHO ROAD	RICHARDSON	TX	75081	972-235-8828
J K L DESIGN GROUP INC	1839 61ST STREET	SARASOTA	FL	34236-4144	(941) 358-4994
JKL DESIGN GROUP, INC.	1839 61ST STREET	SARASOTA	FL	34243	941-358-4994
JM DISTRIBUTORS	8257 LITTLE RIVER DAM ROAD	RADFORD	VA	24141	540-731-6903
JOHN P PICONE INC	PO BOX 9013	LAWRENCE	NY	11559	(516) 239-1600
JOHNSON CO LIBRARY	49 EAST	FRANKLIN	IN	46131	

JOHNSON MATTHEY TESTING	12600 UNIVERSAL DR	TAYLOR	MI	48180	734-946-4321
KAREN LANDWERLEN	5784 IRISH PAT MURPHY DRIVE	PARKER	CO	80134	575-312-2177
KAY-TWELVE.COM	5625 N. HIGH STREET	WORTHINGTON	OH	43085	888-624-5451
KDI DESIGN, INC.	427 NORTH KIRK ROAD	GENEVA	IL	6134	
KEN KEE SERVICES	7150 COUNTY ROAD 50	CARVER	MN	55315	612-750-7446
KEYLINE DISTRIBUTORS	2537 SULPHUR SPRINGS ROAD	SAUQUOIT	NY	13456	315-736-2880
KINGSBURY G.I.D	255 KINGSBURY GRADE	STATELINE	NV	89449	775-588-3548
KINGSCOTT	229 EAST MICHIGAN	KALAMAZOO	MI	49007	269-381-4880 X 294
KIRBY SCHOOL DISTRICT 140	16931 GRISSOM DR	TINLEY PARK	IL	60477	
KPC ARCHITECTURAL PRODUCTS	2464 FORTUNE DRIVE	LEXINGTON	KY	40509	859-269-3646
KRYSTAL COMPANY	1455 LINCOLN PARKWAY	DUNWOODY	GA	30346	770-351-4682
LAFAYETTE MATERIALS MANAGEMENT CO. INC	PO BOX 6187	LAFAYETTE	IN	47903-6187	(765) 447-7400
LAFAYETTE OFFICE SUPPLY	1400 TEAL ROAD	LAFAYETTE	IN	47905	
LANSING BUILDING PRODUCTS	4537 TRANSPORT DRIVE	TAMPA	FL	33605	813-44-6280
LARSON COMPANY	403 SOUTH VERMONT	PALATINE	IL	60067	847-875-7105
LAFAYETTE OFFICE SUPPLY	17 N. 10TH STREET	LAFAYETTE	IN	47901	765-742-2177
LB's Furniture Solutions, LLC	8 Clearview Drive	Spencerport	NY	14559	585-349-0336
LCHIC	1100 GRAMPLAN BLVD	WILLIAMSPORT	PA	17701	
LEE COMPANY INC	27 SOUTH 12TH STREET	TERRE HAUTE	IN	47807	(812) 235-8155
LEE DISTRIBUTORS INC.	PO BOX 447	VERNON	NJ	7462	
LEEWAY FURNITURE COMPANY	528 APPIAN WAY	MATTESON	IL	60443	(312) 730-0842
Leonard Bus Sales	7150 Apple Tree Avenue	Bergen	NY	14416	585-49-0140
LONESTAR FURNISHINGS	4301 REEDER DR	CARROLLTON	TX	75010	972-862-9900
LOUISE K WADE DESIGN	2604 SOLANA WAY	LAGUNA BEACH	CA	92651	949-494-8264
LOWERY MCDONNELL COMPANY	208 OAK RIDGE CIRCLE	WAVERLY	IA	50677	319-596-5120
LOWERY MCDONNELL COMPANY	255 MITTEL DRIVE	WOOD DALE	IL	60191	630-227-1000
LOY'S OFFICE SUPPLIES, INC.	PO BOX 1546	LAGRANGE	GA	30241-1546	

OFFICE ENVIRONMENTS	5805 BARRY ROAD	TAMPA	FL	33634	
OFFICE INSTALLATION COMPANY	804 E 8TH	WICHITA	KS	67214	316-265-2700
OFFICE PRODUCTS PROFESSIONALS	888 S CR 300 E	KNOX	IN	46534	
OFFICE SCAPES	8390 WOLF LAKE DRIVE	BARTLETT	TN	38133	(901) 385-8000
OFFICE TECHNICIANS	C/O SAN-MAN WHSE	ASSONET	MA	2702	
PARTNERS IN PLANNING	5252 CHEROKEE AVE	ALEXANDRIA	VA	22312	(703) 642-0670
PBI, INC.	123 SWEETEN CREEK ROAD	ASHEVILLE	NC	28803	828-277-7001
PEPPER HAMILTON LLP	2900 TWO LOGAN SQUARE	PHILADELPHIA	PA	19103	215-981-4000
PETTER BUSINESS SYSTEMS	PO BOX 1120	PADUCAH	KY	42002	270-443-8461
PMC COMMERCIAL INTERIORS INC.	3000 PERIMETER PARK DRIVE	MORRISVILLE	NC	27560	
PROFESSIONAL OFFICE INSTALLERS	159 WELBORN STREET	GREENVILLE	SC	29601	
R.G. MOELLER	3151 DIXIE AVE	GRANDVILLE	MI	49418	6165349661
R.M. HUFFMAN COMPANY	401 FOURTH AVE	CHARLESTON	WV	25303	800-766-0367
R.V. LEONARD COMPANY, INC.	1362 WASHINGTON ST	WEYMOUTH	MA	2189	781-331-4440
RAY-BLOCK STATIONERY CO.	3 PLAINFIELD AVENUE	FLORAL PARK	NY	11001	516-437-2222
RCF GROUP	6454 CENTRE PARK DRIVE	WEST CHESTER	OH	45069	513-612-7303
RIGHTSIZE FACILITY PERFORMANCE	5000 W ROOSEVELT ROAD	CHICAGO	IL	60644	800-815-8592
RIVER CITY BUSINESS EQUIPMENT	300 44TH ST SW	WYOMING	MI	49548	616-534-6550
RJE BUSINESS INTERIORS	621 EAST OHIO STREET	INDIANAPOLIS	IN	46202	317-293-4051
ROBERTS OFFICE INTERIORS	144 HANGAR ROAD	ROME	NY	13441	315-334-1388
RSFi	401 East Wilson Bridge Rd	Worthington	OH	43085	614-880-9110
SCHOOL FURNISHINGS	33 MAIN STREET	NASHUA	NH	03064-2776	(603) 882-9418
SCHOOL SPECIALTY	P.O. BOX 1017	APPLETON	WI	54912-1017	(920) 734-2756
Sharp School Services, Inc.	6400 Lincolnway	Hobart	IN	46342	219-942-6903
SIGNATURE GRAPHICS	608 S. 9TH ST.	NOBLESVILLE	IN	46060	317-776-8652
SOUTH TEXAS SCHOOL FURNITURE	LAVACA COUNTY OFFICE SUPPLY	HALLETTSVILLE	TX	77964	(361) 798-4364
SPRUCED INTERIORS	3605 CONFLANS ROAD	IRVING	TX	75061	817-925-5851

NATIONAL DEALER

STAPLES - VIRGINIA BEACH	5770 THURSTON AVE	VIRGINIA BEACH	VA	23455	252-436-3157
STAPLES, INC.	4170 HIGHLANDER PARKWAY	RICHFIELD	OH	44286	
STATE UNIVERSITY COLLEGE	350 NEW CAMPUS DRIVE	BROCKPORT	NY	14420	585-395-5141
STATE UNIVERSITY OF NEW YORK	BUSINESS OFFICE-S-116	ALBANY	NY	12246	518-443-5349
STEVENS OFFICE INTERIORS	6804 MANLIUS CENTER RD	E. SYRACUSE	NY	13057	315-362-4144
STUART WALSTON INC	417 WEST NASH STREET	WILSON	NC	27893-3742	(252) 243-4940
SULLIVAN WEST CSD	33 SCHOOLHOUSE RD	JEFFERSON	NY	12748	845-295-4066
SULLIVAN WEST HIGH SCHOOL	6604 STATE ROUTE 52	LAKE HUNTINGTON	NY	12752	

NATIONAL DEALER

NAME	ADDRESS1	CITY	STATE	ZIP	TELEPHONE_NO
SULLIVANS OFFICE SUPPLY	219 CENTER ST.	MASSENA	NY	13662	315-764-0295
SUPPLYSOURCE OFFICE INTERIORS	415 WEST THIRD STREET	WILLIAMSPORT	PA	17701	(570) 327-1550
SYDNYE PETTENGILL ASID	INTERIOR DESIGN INC	ALEXANDRIA	VA	22301	(703) 838-8480
SYNERGY BUSINESS ENVIRONMMENTS	111 10TH AVENUE SOUTH	NASHVILLE	TN	37203	(615) 383-6799
SYSTEMS FURNITURE INSTALLATIONS	1701 NW 5TH STREET	OKLAHOMA CITY	OK	73106	
TACTICAL OFFICE SOLLUTIONS	2 EATON ST	HAMPTON	VA	23669	757-565-6060
TANNER OF PA INC	7813 DERRY STREET	HARRISBURG	PA	17111	800-251-8437
TERRELL ENTERPRISES INC.	PO BOX 461	GREENVILLE	AL	36037	(616) 262-0044
TERRELL'S OFFICE MACHINES	PO BOX 1870	BOZEMAN	MT	59771-1870	(406) 587-4455
THE CHARLES RITTER COMPANY	35 W SIXTH ST / PO BOX 215	MANSFIELD	OH	44901	419-522-1911
THOMPSON HINE	335 MADISON AVE	NEW YORK	NY	10017	212-908-3979
THRIFTY OFFICE FURNITURE	1023 S MIAMI BLVD	DURHAM	NC	27703	919-598-8454
TOTAL OFFICE INTERIORS	527 PLYMOUTH ROAD	PLYMOUTH MEETING	PA	19462	(610) 828-8308
TURN KEY INSTALLATION	PO BOX 251	GRANDVILLE	MI	49468	
ULTIMATE OFFICE	317 FAIRFIELD ROAD	FREEHOLD	NJ	7728	732-410-4978
ULTIMATE OFFICE INC	PO BOX 688	FARMINGDALE	NJ	7707	732-780-6911
UNION OFFICE	226 ANDOVER STREET	WILMINGTON	MA	1887	617-308-7005
UNITED OFFICE PRODUCTS	601 W. DENNIS	OLATHE	KS	66061	913-782-4441

VERHALEN, INC	500 PILGRAM WAY	GREEN BAY	WI	54304	920-431-8900
VETERANS OFFICE INTERIORS	2700 BELLEVUE AVENUE	SYRACUSE	NY	13219	
W B MASON	59 CENTRE STREET	BROCKTON	MA	2303	(508) 586-3434
WASHINGTON WORKPLACE	2300 SOUTH 9TH STREET	ARLINGTON	VA	22204	703-979-7835
WB MASON	647 SUMMER STREET	BOSTON	MA	2210	508-586-3434
WB MASON	29 MILL STREET	ALBANY	NY	12204	
WILLIAMS OFFICE ENVIRONMENTS	407 RAY AVENUE	FAYETTEVILLE	NC	28301	910-483-0354
WORKPLACE INTERIORS	7910 WEST BROAD STREET	RICHMOND	VA	37115	804-270-7333
WORKSCAPES	1395 SW 22ND ST	MIAMI	FL	33145	877-967-5722
WORKSCAPES	9302 FLORIDA PALM DRIVE	TAMPA	FL	33619	
WORKSCAPES INC- ORLANDO	1173 NORTH ORANGE AVE	ORLANDO	FL	32804	813-620-0048
Worthington Contract Furniture, L.P.	3006 Longhorb Blvd.	Austin	TX	78758	512-331-1628
WORTHINGTON CONTRACT FURNITURE, L.P.	3006 LONGHORN BLVD	AUSTIN	TX	78758	
WULBERN-KOVAL COMPANY INC	1111 MORRISON DRIVE	CHARLESTON	SC	29403	843-577-7666
ZIMMERMAN SCHOOL EQUIPMENT	7335 HAVENS CORNERS ROAD	BLACKLICK	OH	43004	

NATIONAL DEALER

NATIONAL DEALER

Attachment 1.4.1 Public Sector Cooperative Contracts

CONTRACT AGENCY	AGENCY LOCATION	LEAD AGENCY	EFFECTIVE DATES	BASE DISCOUNT	SALES
NCPA	HOUSTON, TX	REGION 14 ESC	10/1/15 - 10/31/23	44%	111K
CONNECTICUT, STATE OF	HARTFORD, CT	STATE OF CT, DAS	7/1/15 - 6/30/23	45%	52K
MISSISSIPPI, STATE OF	JACKSON, MS	STATE OF MS, DFA	7/1/21 - 6/30/23	40%	
NEW JERSEY, ED-DATA	SADDLE BROOK, NJ	EDS	12/1/21 - 12/1/22	32%	
NEW JERSEY, ESCNJ	PISCATAWAY, NJ	ESCNJ	7/2/21 - 6/30/24	38%	52K
NEW JERSEY, STATE OF	TRENTON, NJ	STATE OF NJ, DOT	7/30/12 - 7/31/22	46%	5.4K
NEW YORK, ED-DATA	SADDLEBROOK, NJ	CLARKSTOWN CSD	4/1/22 - 3/31/23	32%	
PENNSYLVANIA, STATE OF	HARRISBURG, PA	STATE OF PA, DGS	5/1/17 - 4/30/23	43%	
PENNSYLVANIA, PEPPM PA	MILTON, PA	CSIU	1/120 - 12/31/22	38%	35.6K
TEXAS, TIPS	PITTSBURG, TX	REG 8 ESC	6/22/20 - 5/31/23	46%	

Attachment 1.4.4 References

Customer References	Products/Services Provided	Project Starting and End Dates
<p>Austin Community College Highland Campus -Make It Center 6101 Highland Campus Dr ~Bldg 2000 Austin TX 78752</p> <p>Janelle Green, Director 512-223-1472 Janelle.Green@austincc.edu</p> <p>McKinsey Siebold, Project Manager 512-630-5369 Mckinsey.siebold@austincc.edu</p>	<p>Explorer Series Rover Table Height Adjustable Voyager Table Ethos</p>	<p>June 2022 -May 2023</p>
<p>Hallsville ISD 300 Willow St Hallsville TX 75650</p> <p>Diane Hicks, Secretary to Director of Special Programs 903-668-5990 x5019 dhicks@hisd.com</p>	<p>Voyager Cubby Storage (125+ units)</p>	<p>March 2023 -July 2023</p>
<p>Passaic Community College Engineering Rooms and Classrooms</p> <p>Ned Sheehy, Engineering Teacher 973-300-2100 Lsheehy@sussex.edu</p>	<p>Explorer Series Maker Tables Explorer Series Cargo Carts</p> <p>Fuzion Sit to Stand Tall Storage Units Assemble Series Flip Top Tables</p>	<p>April 2021 -Present</p>
<p>Pennsbury School District Steve Waterson, Purchasing Manager 215-428-4156 swaterson@pennsburyisd.org</p>	<p>Ethos Chairs Echo Tables Fuzion Sit to Stands Think Nooks Explorer Series Maker Tables Assemble Series Tables</p>	<p>January 2019 -Present</p>
<p>Sierra School Equipment Company Philip McDermott, Account Representative 661-865-1003 philipmcdermott@ssecinc.com</p>	<p>Ethos Echo 360 Seating Fuzion Explorer Assemble Voyager</p>	



With our depth and breadth of distributors across the country (see Distributor Partner Document), through them, they each have and facilitate extend service and warranty needs in both a timely and professional manner. Many have their own warehouses to receive replacement products. Many also use these warehouses to pick up products and service them within said warehouse if needed. Further, they can service “on site” needs with their certified professional installers. Most of our distributors/service providers attend certification classes to ensure they have the skills in order to perform the industry services required.

Haskell also facilitates an annual review of all our distributor/partners across the country to insure required performance level expectations are being achieved.

One of the biggest advantages is that we honor our warranties and include labor reimbursement to our distributor partners, which removes any hesitation on their part to facilitate the approved warranty claim. Manufacturers who do NOT re-imburse for labor create a disincentive for their distributors to perform the warranty work and delay resolution.

Haskell Education has made it is easy for our distributors to submit a warranty/service claim by making a simple call to our customer service team which reduces the amount of time for any warranty replacements to be replaced and shipped which in turn allows for servicing arm to deploy and address any need. Any products under warranty therefore likely needing service are expedited under our “Warranty Expedite Program”.

Haskell Office LLC. dba Haskell Education has a Lifetime Warranty which means we have engineered products to last decreasing the likelihood of a service/warranty need.

Haskell has consistently preformed at the highest level of service for our distributor/partners and end users/customers without hesitancy. They believe in making certain the customer is taken care of and they are happy.



Multiple Distributors: Independent, Contract, Larger Nationals, Wholesalers and those in-between providing your members “choice” of whom they would like to work with. Our experience tells us that not all Public Sector customers like to work with the same dealer. It also provides a Public Sector customer another distributor option when a single distributor fails to perform therefore having no impact on the possible rebate dollars realized. To date, between all these distributors across the country, we have over 1500 “feet on the street” selling our products across the country. Higher number of distributors equates to an improved number of sales opportunities which in turn, increases the rebate dollars.

Leadership Team has over 70 years combined experience working with the Public Sector customers to include K12, Higher Education, State, Local and Federal Government

We manufacture unique STEAM Products i.e.: ROVER – Maker Table where the top flips up and allows the table to move through a door threshold for a “pop up” maker experience. This solution, because it can be a shared resource, results in a reduction of acquisition costs. It also is a reduction in custodian man-hours when there is a need to move the Maker Table out of a room as the top needs to be removed first and then be reattached. THIS SOLUTION ONLY EXISTS AT HASKELL EDUCATION

<https://www.haskelledge.com/videos/the-rover-table-and-cargo-cart/>

We are steel benders! When we think about the need for Mobility and Flexibility we like to state: Steel and Mobility = Longevity providing your member with the greatest long-term return on their Investment

Interactive and easy to navigate web site with relevant content targeted directly to our education audience “Distribution Breath” of geography across the country

Due to the breadth of our distributor partners, we have experts in every Public Sector Market
Long distribution relationship

Distribution Annual Performance Reviews

Professional Development at “no charge” to your member. This service is critical as part of the early programming of deciding on product solutions as well as post purchase so stakeholders (generally educators) understand how to utilize them

EQUALIS GROUP dedicated customer service support person

Design and Space Planning Services: both with our distributor partners and direct with Haskell Education

Rendering Services: both with our distributor partners and direct with Haskell Education

Virtual Reality and “Walk Through” Services with both our distributors and Haskell Education

CEU’s offered to A & D Community. Critical component to getting products specified on a project is to have strong relationships with the A & D Community

Support at the corporate office as well as the distributor locations across the country through our distributor partners and our Independent Rep Firms

Showrooms across the county to support your members with seeing product before they purchase

Community Engagement Workshops and Research Exercises

Personalized “Look Books”. We build Look Books which is a series of digital environments for member to use with their boards and any of their stakeholders to tell the story they need in order to assist with better understanding the direction of a project

Engagement Research Partner Program

“Select your color feature” on our website. Member can see what their product color will look like online

Member Education Seminars i.e.: Trends in Higher Education or How to create deeper student Engagement

“Road Show” across the county – Product Samples come to you

Test Fit Programs – “Try before you buy”. We have programs that allow your members to try our products prior to the purchasing of said product

Student Engagement = Improved Performance – Process for “how to”



Lifetime Guarantee

The following limited Lifetime Guarantee applies to all Haskell products:

Haskell guarantees, to the Original Purchaser of this Haskell furniture, all parts to be free from defects in material and workmanship; and as long as the Original Purchaser owns this furniture, we will replace any metal part or parts thereof which our examination discloses to be defective, provided no unauthorized corrective action has been taken prior to such examination. Please note, this guarantee does not apply to product misuse, abuse, or alteration. We do not cover damage caused by accident, fire, flood or act of God.

Exceptions to the Haskell Lifetime Guarantee

Ethos Series – 12 years on casters, glides, pneumatic cylinders, tablets and tablet support arms.

360 Series – 12 years on casters, glides.

Echo™ Series – marker board laminates are subject to manufacturer's published warranty.

Explorer Series® – 12 years on casters and pneumatic cylinders.

Fuzion™ Sit Stand Series – 12 years on casters, glides, and adjust mechanism. 20 years on hydraulic cylinder.

Attachment 3.1.1 Showroom Locations / Distribution Centers

SHOWROOM LOCATIONS

Dealer	City	State
School Source	Mesa	AZ
Arizona Furnishings	Phoenix	AZ
Sierra School Equipment	Bakersfield	CA
Sierra School Equipment	Bakersfield	CA
Campbell Keller	Sacramento	CA
Cal Bennetts	Visalia	CA
W.B.Mason	Hamden	CT
Robert Lord's	Manchester	CT
Ernie Morris	Bushnell	FL
W.B.Mason	South Dayton	FL
Ernie Morris	Cumming	GA
Haskell Showroom	Dennisport	MA
W.B.Mason	Woburn	MA
W.B.Mason	Worcester	MA
Workplace Resources	Worcester	MA
American Design	Towson	MD
Haskell Education Factory Showroom	Wyoming	MI
JLM Innovators	Hampton Falls	NH
School Furnishings	Hudson	NH
Webb Contract Group Showroom	Columbus	OH
W.B.Mason	Warwick	RI
Alfred Williams	Austin	TX
Hertz Furniture	Houston	TX
Office Depot	Houston	TX

Distribution Centers

3770 Hagen Dr. Wyoming MI 49548

459 36th St., Wyoming MI 49548

350 28th St. Grand Rapids, MI



Describe your company's Customer Service Department (hours of operation, number of service centers, etc.)

EQUALIS GROUP members will reach out to our distributor/dealer partners first should there be a customer service question(s). Each of our dealer partners have a resolute customer support staff to complete all resolutions to include installation, warranties, service, concealed damage, shipping, and deliveries.

Haskell Office dba Haskell Education, LLC. customer support department and their distributor partners are open in their time respective time zones from 8 am – 6 pm.

Haskell Education has a dedicated customer support team that participates in daily operations and production meetings every morning. This protocol ensures that there are clear and quick communications between sales and operations which in turn allows us to provide our distributors with expedient information for their customers.

Lean kit is just one of our order entry and production management tools that our customer support team has access to and utilizes alongside our operations and production teams. This tool allows the customer support team to quickly view all operations and production data again assisting with what might be needed in supporting our dealer partners.

We also have a company culture that calls for taking care of the end user in an expedient, efficient, fair and thoughtful manner. For example, the customer support team support an initiative that replies to quote requests the same day or at the outset no more than 24 hours. They seek "win/win" solutions always seeking the best and most efficient solution for the end user (customer). The leadership team nurtures this culture throughout the organization.



Our products are independent green certified

Haskell's primary material is steel. Steel is the most recycled post-consumer material used in North America. More steel is recycled than all other metals, paper, glass and plastic combined. The use of recycled steel does not degrade any performance characteristics of steel. Powder Coating Haskell's products are designed around the newest steel coating technology. All steel parts and products are coated with powder that is cured in an oven. This offers superior durability and performance while eliminating waste and pollutants. Powder coating is in the enviable position of eliminating ozone layer eroding VOC (Volatile Organic Compounds). Adhesives In keeping with our powder coating that helps eliminate harmful VOC's. Haskell's Marathon seating incorporates the use of virtually VOC free adhesives when producing our seating product. We follow the stringent Ansi/Bifma M7.1 guideline set for VOC adhesives. Every step in our process we are evaluating and using methods that eliminate our carbon footprint. Packaging Delivery of an undamaged unit on-site is a positive alternative to manufacturing a replacement in terms of energy and materials. For the last three years Haskell has consistently reduced the cardboard content of it's packaging by more than half while decreasing shipping damage. Corrugated cardboard used by Haskell contain at least 25% recycled materials. And More Haskell's manufacturing process and facility is a 99% solvent-free environment, and the company is as dedicated to the conservation of our natural resources as it is to the elimination of pollutants. All forklifts have been converted from gasoline to either natural gas or electric power or have been replaced by electric scissor lifts and gravity fed roller tables.

HASKELL ENVIRONMENTAL STATEMENT

Haskell has provided federal agencies, schools and the contract furniture markets, with furniture that is known for its extra- long-life cycle. Our furniture is constructed from steel, the most widely recycled material in North America. These products are a key value for Haskell in serving the community, including acting responsibly. In this vein, Haskell has demonstrated an exceptional commitment to Environmental improvement.

Haskell has always taken the commonsense approach in designing both quality and durability into its products. This equates to an item of furniture that does not have to be replaced for a long, long time. Our furniture will commonly exceed the life cycle of wood furniture by two to three times. The life cycle assessment of Haskell's products must include the many clients using our furniture that have been in service for over twenty-five years, and plan to continue to use the furniture for years to come. Simply put, if a client does not have to replace furniture every 7-10 years, no energy is expended, and no disposal issues need to be considered. This is, by definition, "waste prevention."

STEEL

Haskell's primary material is steel. Steel is the most recycled post consumer material used in North America. More steel is recycled than all other metals, paper, glass and plastic combined. Industry wide, in 1998, 70 million tons of steel scrap was recycled, for a 63.8% overall recycling rate. Steel that is recycled when compared to virgin ore requires 74% of the energy, generates 86% less air pollution, and 76% less water pollution. Recycled steel accounts for well over half of the steel produced in the U.S.

Haskell specifies steel to meet certain performance characteristics that will yield quality furniture. The advantage of steel versus other materials, such as plastics and woods, is that the content of recycled steel does not degrade these performance characteristics. The steel recycled from a thirty-year-old Haskell file can be reprocessed into a new Haskell file. Haskell's manufacturing process sends 100% of all off-fall, slugs and scrap to recycling centers as a method of waste reduction. Typical post-consumer recycling rates for major steel products include 72% of appliances and 92% of automobiles. While there is no industry data on recycling of steel-based furniture, the institutional nature of Haskell's market should place the recycling rate between that of consumer appliances and the more traditional reclamation of automobiles. This is, by definition "waste reduction."

POWDER COATING

Haskell's new facility was designed around the newest steel coating technology, products are coated with powder that is cured in an oven. This offers superior durability and performance while eliminating waste and pollutants. Powder coating is in the enviable position of eliminating ozone layer eroding VOC (Volatile Organic Compounds); while water-based paints for industrial usage (one of the best of the liquid coatings) is still likely to release 1 to 2 pounds of VOC per gallon. Traditional solvent-based liquid paint contains approximately 7.25 pounds of reducing solvents per gallon of paint. Powder has none.

When compared to wood finishing systems, to cover 1000-sq. ft., a lacquer 3-coat system will release approximately 196 pounds VOC, a good solvent-based liquid paint onto steel will release approximately 7 pounds VOC, and powder will release 0 pounds VOC. Because powder coatings do not contain solvents, exhausting or venting to the outdoors of the curing ovens are not required to remove solvent fumes.

In the powder coating process, waste is greatly reduced by overspray recovery units that recycle and reuse 95-99% of the powder, compared to the material utilization of 40-70% for a liquid paint system. With powder coatings there is no overspray sludge to accumulate and dispose. Powder coatings require no solvents, no mixing rooms and no flash-off zones. Clean up is accomplished without solvents.

Superior performance of powder coatings when compared to liquid paint will extend the useful life of the product. Haskell's powder coating is harder, more scratch resistant, less likely to peel if dented, and more chemical and corrosion resistant, than past Haskell products which themselves are performing beyond normal life cycles. As an example, salt spray resistance test results (an indication of the corrosion resistance and the adhesion of a coating) have increased from 100 hours to 700 hours with Haskell's powder coating. To add longevity to the products, the hybrid powder coatings that have been formulated for Haskell product can be repaired, touched-up and even re-painted.

Powder coatings do not interfere with the recyclability of the steel substrate and are in fact classified as a "non-hazardous" waste when disposed.

Dimensional lumber utilizes only 63% of a tree. Engineered substrates from trees, on the other hand, convert all but about 5% of the balance of the tree, processing material that was once either burnt or disposed of as solid waste into usable products. Haskell has introduced an annually renewable wheat straw-based substrate to our market that has superior moisture and mechanical properties than other typical panels, that is formaldehyde free, and that qualifies for various LEEDS categories.

PACKAGING

Delivery of an undamaged unit on-site is a positive alternative to manufacturing a replacement in terms of energy and materials. For the last three years Haskell has consistently reduced the cardboard content of its packaging by more than half while decreasing shipping damage. Recently, the company brought a "packing on demand" system online that custom tailors packaging to the size and quantity run. This has already reduced cardboard consumption and shipping damage. Corrugated cardboard used by Haskell contains at least 50% recycled materials, while the kraft papers used in packaging are from 100% recycled materials. Packaging is normally sent to a recycling center after installation by the user agency.

...AND MORE

Haskell's manufacturing process and facility is a 99% solvent-free environment, and the company is as dedicated to the conservation of our natural resources as it is to the elimination of pollutants. All forklifts have been converted from gasoline to either natural gas or electric power or have been replaced by electric scissor lifts and gravity fed roller tables. Cooling water for spot-welding previously sent to the sewer is now recycled, saving several million gallons of water per year as well as the energy used downstream in reclamation or treatment.

Haskell Education Organizational Chart



Alan Robins
President

Bruce Robins
Vice President

Cristel Hutchinson
Vice President Sales

Adam Johnson
Operations Director

Administrative Director

John Myers
Marketing & Training
Director

Tim Kerfien
Customer Support
Manager/Contract Manager

Kathryn Pagano
Julie Griffin
Flora McClung
Regional Managers

6 Rep Firms
Multiple
Locations

Plant Floor Staff

Plant Administrative
Staff

Karen Drapela
Senior Customer
Support Specialist

Mindy Gilbert
Customer Support
Specialist

5.2.1. Contract Expectation

Haskell Educations expectations for the CCOG contract is that we expand our National Public Sector Sales. In addition to the regions where we have already realized strong public sector sales, we want to target those states where we believe there is significant opportunities with the CCOG Contract.

While we have developed a proven strategy for Public Sector sales growth, we are expecting to work directly with the CCOG Team to build joint eMarketing, Regional and National opportunities to support the growth of the contract.

We would expect to partner with the CCOG Team on building new members and growing existing members.

Haskell Education will be expecting a partnership with the CCOG Team with consistent and clear communication. As part of this partnership, we look forward to having a presence on your website with as much content as you will allow.

Finally, we would look to the CCOG Team to provide us with their guidance on what has and has not been effective with the growth of the contract and how best they feel we should interface with their members.

5.2.2. Five (5) Year Sales and Vision Strategy

Marketing and Sales Support:

Haskell Education has been in business for over 70 years. We have been extremely successful within the Public Sector communities by operating with a high degree of integrity, professionalism, innovation, reliability and always seeking solutions for our customers that solve for the “why”.

Below is a map of the steps Haskell Education will be taking to support and grow the CCOG Contract for the Five (5) Years as well as more immediate steps.

Haskell Education will use the full resources of our sales, marketing and public relations teams to fully promote our partnership with CCOG members.

We will exploit all our channel media outlets with a coordinated program of advertising and press releases around this award. In addition, we will produce and distribute full announcements targeted at our existing public sector customers, target public sector customers and any database provided by CCOG. Lastly, we will market the CCOG Contract immediately to all our distribution partners / dealers combined with full training of dealer and Haskell sales teams on use and benefits of the CCOG Contract.

1. Haskell will create a full press release program utilizing our inside and outside PR teams to effectively reach the appropriate trade publications and media outlets including but not limited to the following:
 - School and Planning Management
 - College and Planning Management
 - Interiors and Sources
 - Learning By Design
 - Issues in Education
 - Educational Dealer
 - American School & University
 - The Business of Furniture
 - The Monday Morning Quarterback
 - School Construction News
 - Workplaces Magazine
 - Christian School Products
 - A4LE
 - Contract Magazine
2. Within the First 30 days of contract award, Haskell Education will post an announcement, the Master Agreement details and specific contact information on our website, www.haskelleducation.com of the CCOG Contract award.
3. The Haskell Education marketing team will, in the first 30 days, create a co-branded marketing set of materials including the following:
 - Full color, 2 page 8 ½” x 11” announcement and guide document to be included with sales proposals and presentation materials.
 - Easy to read post card for quick leave behind on all Haskell Sales appointments with potential and existing CCOG members.
 - Trade Show Tent cards promoting the CCOG Contract
 - PDF versions of above on our web site for electronic mailing by our sales and dealership networks.

4. The Haskell Education Sales and Marketing team will support all CCOG national and regional conferences including all supplier-specific trade show, Regional Cooperative Summits and meetings throughout the term of the contract. We will support these meetings and conferences with appropriate product and marketing materials as needed. We have a proven trade show and meeting program support team that will be ready to participate in the above.

5. Within 60 Days of award of the CCOG contract, Haskell Education will develop a fully articulated, ongoing advertising campaign for both regional and national publications promoting the CCOG contract. In addition, we will create a set of tools for our regional sales teams and distributors for use at any local / regional trade show, furniture fairs etc. where public sector customers might meet the Haskell Education brand.

6. Within 90 days of award of the CCOG contract, Haskell Education will create templates for case studies, collateral pieces (2-page, 4-page and postcards) and presentations that can be utilized during the term of the contract by all of Haskell Education sales *and* distribution partners. We see it as essential to not only create these templates for Haskell sales but provide them to our national distribution network for use in their ongoing marketing efforts where co-branding of CCOG partners and Haskell Education can be included in their extensive marketing efforts.

7. Within 30 days, Haskell Education will conduct a Webinar training experience which will be required by our sales team members across the country with encouraged attendance by our national distribution team. These training sessions will review the CCOG Contract, pricing and product inclusions, and review our 90-day marketing plan.

Outside of the 90-day marketing program we will develop an ongoing marketing plan through the life of the 5-year contract. I believe it is important to understand how we utilize trade shows as a marketing tool. Please see below.

Trade Shows whether attending and/or showing are and will continue to be an important component to Haskell Education's sales strategy success in that they provide expansive visibility to multiple stakeholders. Our data base consists of thousands of Public Sector contacts that are continually scrubbed by our IT team. We use the data base gained from trade shows to introduce new contracts, eMarket, build a new customer base, support our distributor partners, gather market feedback for product and process development, case studies, market development programs when we are trying to build a new market, press releases, new product announcements, contests, and education surveys.

With all usages state above, we will be introducing the CCOG contract whether with a logo, conversation and/or printed marketing material. This number equates to many thousands of stakeholders.

SOME KEY HASKELL EDUCATION TRADE SHOWS:



Ed Spaces Trade Show. Largest K12 trade show in the United States



A4LE Shows Regional Shows: Midwest, Great Lakes, Northeast, Pacific Northwest, Southeast, Southern & Southwest.



California Coalition for Adequate School Housing (CASH) Show



California Steam Symposium



National Association of Educational Procurement



International Facility Management Association



Association of School Business Officials International. We attend regional conferences across the country

NeoCon

During the five (5) year term of the CCOG Contract, Haskell Education will provide marketing, sales, partnership development and administrative support for both our distributors, A & D communities, and our current public sector contacts as well as our newly acquired public sector contacts that directly promotes the CCOG Contract. We will be promoting the contract on a national basis.

Haskell Education will assign a dedicated customer support contact who will serve as the main point of contact for Haskell Education and will be responsible for managing the overall relationship with CCOG. The Director of Partner Development will work with the CCOG to develop a comprehensive strategy to promote the contract with appropriate stakeholders within CCOG including, Sales, Marketing, Contracting, Training, and Operations & Support.

Haskell Education's marketing team will work to promote the CCOG Contract to both existing Participating Public Agencies and prospective Public Agencies through channels that will include:

- A. Marketing collateral (print, electronic, email, presentations)
- B. Website
- C. Trade shows/conferences/meetings
- D. Advertising
- E. Social Media
- F. Regionally Hosted Events
- G. Virtual Experiences

Haskell Education sales teams will work in conjunction with our distributors and A & D communities across the country to promote the CCOG Contract to both existing Participating Public Agencies and prospective Public Agencies

through initiatives that may include:

- A. Individual sales calls
- B. Joint sales calls
- C. Webinars
- D. Joint Hosted Events

Contract Deployment:

Upon receiving the CCOG Award, Haskell Education will schedule webinars with all our stakeholders to include our Executive Management, Regional Managers, Marketing Department, Entire National Distribution base, A & D Community and Public Sector Contract List.

Upon contract award, we will immediately add the contract to our website.

On a quarterly basis, we will review sales and marketing steps with our distributors. Haskell Education will also include the CCOG Contract on every training facilitated both in person and via webinars with all our stakeholders (distributors, A & D Firms and Public Sector Contacts). We facilitate trainings at least 10+ times per week.

Haskell Education will be completing a Press Release upon the CCOG Award which will be sent out on the wire as well as emailed to our entire database of Public Sector folks as well as our distributors.

A consistent cadence of contacting our Public Sector customers will be implemented with person visits, invitations to our hosted regional events, eMarketing, participation in public sector regional events, working with CCOG staff to participate in whatever marketing opportunities they will support us with and creative offering of services (*See Value Added Services below*).

Value Added Services:

Multiple Distributors: Independent, Contract, Larger Nationals, Wholesalers, and those in-between providing your members “choice” of whom they would like to work with. Our experience tells us that not all Public Sector customers like to work with the same dealer. It also provides a Public Sector customer with another distributor option when a single distributor fails to perform, therefore having no impact on the possible rebate dollars realized. To date, among all these distributors across the country, we have over 1500 “feet on the street” selling our products across the country. A higher number of distributors equates to an improved number of sales opportunities which in turn increases the rebate dollars.

Leadership Team has over 70 years combined experience working with the Public Sector customers to include K12, Higher Education, State, Local and Federal Government

We manufacture unique STEAM Products i.e.: ROVER – Maker Table where the top flips up

and allows the table to move through a door threshold for a “pop up” maker experience. This solution, because it can be a shared resource, results in a reduction of acquisition costs. It also is a reduction in custodian man-hours when there is a need to move the Maker Table out of a room as the top needs to be removed first and then be reattached. THIS SOLUTION ONLY EXISTS AT HASKELL EDUCATION

<https://www.haskelleducation.com/videos/the-rover-table-and-cargo-cart/>

We are steel benders! When we think about the need for Mobility and Flexibility we like to state: Steel and Mobility = Longevity providing your member with the greatest long-term return on their investment

Interactive and easy to navigate web site with relevant content targeted directly to our education/public sector audience “Distribution Breath” of geography across the country.

Due to the breadth of our distributor partners, we have experts in every Public Sector Market Long distribution relationship.

Distribution Annual Performance Reviews

Professional Development at “no charge” to your members. This service is critical as part of the early programming of deciding on product solutions as well as post purchase, so stakeholders understand how to utilize them.

CCOG, Public Sector dedicated customer service support person.

Design and Space Planning Services: both offered by our distributor partners and Haskell Education

Rendering Services: both with our distributor partners and direct with Haskell Virtual

Reality and “Walk Through” Services with both our distributors and Haskell Education

CEU’s offered to A & D Community. Critical component to getting products specified on a project is to have strong relationships with the A & D Community

Support at the corporate office as well as the distributor locations across the country through our distributor partners and our Independent Rep Firms

Showrooms across the county to support your members seeing product

Community Engagement Workshops and Research Exercises

Personalized “Look Books”. We build Look Books which are a series of digital environments for members to use with their boards and any of their stakeholders to tell the story they need to assist with better understanding the direction of a project.

Engagement Research Partner Program

“Select your color feature” on our website. Members can see what their product color will look like on- line.

Member Education Seminars i.e.: Trends in Higher Education or How to create deeper student engagement.

“Road Show” across the county – Product Samples come to you.

Test Fit Programs – “Try before you buy”. We have programs that allow your members to try our products prior to the purchasing of said product.

Student Engagement = Improved Performance – Process for “how to”

5.2.3. Sales Objectives. What are your top line sales objectives in each of the five (5) years if awarded this contract?

Year one (1)

Introduce the contract features and benefits Nationally to both our stakeholders (distributors, A & D, Haskell Education Team, and Public Sector CCOF members and our public sector database).

Convert a percentage of cooperative memberships to CCOG Contract based on feedback from CCOG Team.

Add percentage of members to the CCOG Contract based on CCOG Consult

First Year Annual Sales Goal of \$500K

Year two (2)

The Haskell Education Team continues regular relationship cadence with CCOG members and distributors with a contact matrix for measurable results.

Convert a percentage of cooperative memberships to CCOG Contract based on feedback from CCOG Team.

Add percentage of members to the CCOG Contract based on CCOG Consult

Assess what was successful and what was not. Where can we improve?

Reassess Sales Growth Percentage

Year three (3)

The Haskell Education Team continues regular relationship cadence with CCOG members and distributors with a contact matrix for measurable results.

Convert a percentage of cooperative memberships to CCOG Contract based on feedback from CCOG Team.

Add percentage of members to the CCOG Contract based on CCOG Consult

Assess what was successful and what was not. Where can we improve?

Reassess Sales Growth Percentage

Year four (4)

The Haskell Education Team continues regular relationship cadence with CCOG members and distributors with a contact matrix for measurable results.

Convert a percentage of cooperative memberships to CCOG Contract based on feedback from CCOG Team.

Add percentage of members to the CCOG Contract based on CCOG Consult

Assess what was successful and what was not. Where can we improve?

Reassess Sales Growth Percentage

Year five (5)

The Haskell Education Team continues regular relationship cadence with CCOG members and distributors with a contact matrix for measurable results.

Convert a percentage of cooperative memberships to CCOG Contract based on feedback from CCOG Team.

Add percentage of members to the CCOG Contract based on CCOG Consult

Assess what was successful and what was not. Where can we improve?

Reassess Sales Growth Percentage



haskell
EDUCATION
Learn. Think. Do.™

Price List

August 2023

8.21.23



<https://www.haskelleducation.com>

Haskell Education's Price List reflects pre-discount pricing. Please contact Haskell Education or your local approved Haskell Education Dealer for final delivered and/or installed pricing.

Lifetime Guarantee

The following limited Lifetime Guarantee applies to all Haskell products:

Haskell guarantees, to the Original Purchaser of this Haskell furniture, all parts to be free from defects in material and workmanship; and as long as the Original Purchaser owns this furniture, we will replace any metal part or parts thereof which our examination discloses to be defective, provided no unauthorized corrective action has been taken prior to such examination. Please note, this guarantee does not apply to product misuse, abuse, or alteration. We do not cover damage caused by accident, fire, flood or act of God.

Exceptions to the Haskell Lifetime Guarantee

Ethos Series – 12 years on casters, glides, pneumatic cylinders, tablets and tablet support arms.

Echo™ Series – marker board laminates are subject to manufacturer's published warranty.

Explorer Series® – 12 years on casters and pneumatic cylinders.

Fuzion™ Sit Stand Series – 12 years on casters, glides, and adjust mechanism. 20 years on hydraulic cylinder.

Contents

alphabetical

General Information	6	Explorer Series®	
Finish Guide	8	Rover® Table	69
360 Series		Explorer Series® Maker Table	75
360 Series Chair	12	Explorer Series® Cargo Cart	87
360 Series Stool	15	Explorer Series® Storage Carts	97
Assemble Series		Explorer Series® Think Nook™	101
Assemble Series Conferencing & Multi-Purpose	20	Fuzion™ Series	
Assemble Series Training Tables	21	Fuzion™ Series Sit to Stand Desk	103
Captiva™ Series		Fuzion™ Series Teacher's Lectern with Storage ...	105
Captiva™ Series Pedestals	24	Fuzion™ Series Teacher's Desk	106
Captiva™ Series Lateral Files	28	Marathon Series	
Captiva™ Series Wardrobe & Storage Cabinets	29	Marathon Series Desking & Storage	111
Captiva™ Series Vertical Files	35	Marathon Series Seating	119
Captiva™ Series Bookcases	38	Market Series	
Disco Series		Market Series Pedestals	123
Disco Series Stool	41	Market Series Lateral Files	126
Echo™ Series		Market Series Wardrobe & Storage Cabinets	128
Echo™ Series Instruction Zone	44	Market Series Vertical Files	136
Echo™ Series Individual Student Desk	45	Market Series Bookcases	139
Echo™ Series Training & Teaming Tables	48	Market Series Desking	142
Echo™ Half Round Training Table	51	Market Series Instruction Zone	152
Echo™ Series Meeting Tables	55	Smart Series	
Echo™ Series Easel, Marker Boards and Rails	57	Smart Series Desking	155
Ethos Series		Smart Series Instruction Zone	165
Ethos Series Storage Base	62	Voyager Series	
Ethos Series Five Star Base	64	Voyager Series Tables	169
Ethos Series Stool Height	65	Voyager Series Storage Carts	171

Contents

by type

General Information	6
Finish Guide	8
Filing & Storage	
Market Series Pedestals	123
Market Series Lateral Files	126
Market Series Wardrobe & Storage Cabinets	128
Market Series Vertical Files	136
Market Series Bookcases	139
Captiva™ Series Pedestals	24
Captiva™ Series Lateral Files	28
Captiva™ Series Wardrobe & Storage Cabinets	29
Captiva™ Series Vertical Files	35
Captiva™ Series Bookcases	38
Desking	
Market Series	142
Marathon Series	111
Smart Series	155
Carts, Lecterns & Instruction Zone	
Market Series Instruction Zone	152
Smart Series Instruction Zone	165
Echo™ Series Instruction Zone	44
Echo™ Series Easel, Marker Boards and Rails	57
Explorer Series® Cargo Cart	87
Explorer Series® Storage Carts	97
Voyager Series Storage Carts	171
Explorer Series® Think Nook™	101
Makerspace	
Rover® Table	69
Explorer Series® Maker Table	75
Explorer Series® Cargo Cart	87
Explorer Series® Storage Carts	97
Explorer Series® Think Nook™	101
Tables	
Assemble Series Conferencing & Multi-Purpose	20
Assemble Series Training Tables	21
Echo™ Series Instruction Zone	44
Echo™ Series Individual Student Desk	45
Echo™ Series Training & Teaming Tables	48
Echo™ Half Round Training Table	51
Rover® Table	69
Explorer Series® Maker Table	75
Voyager Series Tables	169
Seating	
Ethos Series Storage Base	62
Ethos Series Five Star Base	64
Ethos Series Stool Height	65
Marathon Series Seating	119
Rover® Table Stool	70
Explorer Series® Think Nook™	101
Sit to Stand	
Fuzion™ Series Sit to Stand Desk	103
Fuzion™ Series Teacher's Lectern with Storage	105
Fuzion™ Series Teacher's Desk	106

General Information

Prices

All prices are subject to change without notice.

All orders will be accepted for delivery within prevailing lead time at prices in effect at the time that the order is received by us.

Please call Customer Support for current lead times.

Lifetime Guarantee

All Haskell products are covered by the following limited Lifetime Guarantee:

Haskell guarantees, to the Original Purchaser of this Haskell furniture, all parts to be free from defects in material and workmanship; and as long as the Original Purchaser owns this furniture we will replace any metal part or parts thereof which our examination discloses to be defective, provided no unauthorized corrective action has been taken prior to such examination. Please note this guarantee does not apply to product misuse, abuse, or alteration. We do not cover damage caused by accident, fire, flood or act of God.

Exceptions to the Haskell Lifetime Guarantee

Ethos Series – 12 years on casters, glides, pneumatic cylinders, tablets and tablet support arms.

Echo™ Series – marker board laminates are subject to manufacturer's published warranty.

Custom Finish Program

Custom Paint Finish – All Haskell standard paint colors consist of a two coat electrostatic enamel process, providing a high impact and fade resistant finish. At Haskell we offer you any paint color through our paint matching program and all custom paint colors are offered in the same two coat electrostatic enamel process as our standard offering. There will be an upcharge for custom paint colors as follows:

- 1) For orders of 20 pieces or more, excluding accessories, add \$250 net charge per color, per order.
- 2) For orders of less than 20 pieces, excluding accessories, add \$500 net charge per color, per order.

Bright whites, bright colors and micas are available but are quoted on a per job basis and charges may differ from those listed above. If in question, please submit a sample to Haskell Customer Support.

Custom Plastic Finish – At Haskell we offer you any plastic color through our plastic matching program, allowing clients to customize the Ethos Series for your specific project needs. There will be quantity requirements of 300 piece and an upcharge for the plastic matching program, please contact your local sales representative for more information and pricing.

Custom Approval Process – Submit two samples for Haskell to match, we will return the matched sample for your signed approval. Please add 15-20 working days to normal lead times to allow for custom finishes. Samples should be sent to address listed below and tagged with the project name.

Engineering Specials (non-catalog products)

Prices for non-catalog products (any variation in size,color or other standards from our catalogued items) will be supplied upon request. Orders for non-catalog products will be accepted only with a valid quotation number appearing on the customer's order. Non-catalog products are not subject to standard lead times.

Contact Customer Support for quotation and lead time information.

Freight Damage and Claims

We carefully inspect and pack our products before we release them to the carrier. Everything is packaged to prevent damage in transit. We select the best carriers available who transport furniture on a regular basis. Once we provide it to the carrier, we cannot be responsible for damage in shipment as the transportation company assumes complete responsibility for delivering the product to you in good condition. So, when you take delivery of the product, protect yourself by noting on the bill of lading the extent of any damage or shortage before signing it. Concealed damage and/or any manufacturer defects must be reported to Haskell Education Customer Support at sales@haskelleducation.com as soon as discovered but not later than 15 days from receipt of shipment. Our Customer Support staff will assist in helping you to file the claims should you desire.

Freight

The cost of freight to the contiguous 48 states is included in the cost of the product on orders with a list price of \$22,250 or more provided that the order ships to a single address. Multiple orders shipping to one location on one day will be combined to reach the \$22,250 list price. Customers should specifically request that orders ship together if they want to combine orders for freight savings. Such a request may result in a delay until all orders are ready for shipping.

Ethos Series – free freight with 25 chairs or more.

Changes and Cancellations

Given our short lead times, cancellations or changes to product models, colors, sizes or quantities can only be accepted within the week of order entry. Please contact Customer Support to find out what options are available.

NOTE: PUT IT IN WRITING!

All changes and cancellations must be sent via fax or e-mail to ensure accurate recording of your change request. Non-catalog items or "Engineering Specials" (any product variation in size, color, or other standard from our regularly catalogued items) require 50% deposit with the order, which will be forfeited in the event of cancellation after the first week of order entry.

General Information

How to Place an Order

Provide the following information:

1. P.O. Number
2. "Bill to" and "ship to" name and address
3. Quantity
4. Complete model number
5. Brief description
6. Options (where applicable)
 - a. Special keying instructions
 - b. Paint finish (specify by name and number)
 - c. Top finish (specify by name and number)
 - d. Trim options (where applicable)
 - e. Accessories

Order Entry and Communications

All communications and orders should be directed to our offices at:

Haskell, LLC.	Telephone: 800.334.8888
273 Montgomery Avenue	Facsimile: 724.265.1223
Bala Cynwyd, PA 19004	sales@haskelloffice.com

Order Acknowledgements

All customer orders are acknowledged in writing by fax or e-mail. You can expect to receive an acknowledgment within 48 hours after entering your order. We would ask you to confirm that the acknowledgement is correct within two days. If we do not hear from you, we will advise you that production is commencing on your order as shown on your acknowledgement.

Returns

All returns must be approved and authorized in writing by Haskell Customer Support before any return can take place. In those instances where a return has been authorized, shipments will not be accepted unless accompanied by a written authorization from Haskell Customer Support Department. Merchandise must be returned in original shipping materials. A restocking fee will apply.

Storage

If you are not able to accept delivery within a week of the acknowledged ship date, we can store the product, at your expense. If Customer Support is notified in time to delay production, storage charges can be avoided. Please notify Customer Support in writing of any schedule changes immediately and they will try to accommodate your request.

GSA - U.S. General Services Administration

Contract Number: GS-27F-029DA

Contract Period: Contact your sales representative

Approved Product: Complete Line from Haskell

Federal Supply Schedule: FSC Group 71, Part 1 / Office Furniture / FSC Class 7110

Special Item Numbers (SIN): 711-1, 711-2, 711-3, 711-7, 711-8

Business Classification: Small Business

Discount: Contact your sales representative

End-User Prompt Payment Terms: 1% 20 days, net 30 days

Accepted Credit Cards: MasterCard, Visa, American Express, Discover















Maximum Order Limitation: \$500,000

Freight Program: 1-20 Units, Origin. 21+ Units, Destination

Lead Times: 4-6 weeks

Finish Guide

worksurface options: Assemble, Echo™, Fuzion™, Smart, Marathon, Market

WOOD GRAIN LAMINATE	HASKELL CODE	PATTERNED LAMINATE	HASKELL CODE
 Asian Night 7949-38	NI	 Casual Linen 4943-38	LC
 Fusion Maple 7909-60 (HA)	H	 Classic Linen 4943-38	LN
 Grey Elm 8201-38	GE	 Grey Nebula 4622-60	GN
 Harvest Maple 7953-38	MH	 Pressed Linen 4991-38	PN
 Montana Walnut 7110-60 (MT)	K	 Shadow Zephyr 4857-60	ZS
 Natural Rift 7954-38	NA	 White Tigris 4783-60	TG
 Neo Walnut 7991-38	NW	SOLID LAMINATE HASKELL CODE	
 Wild Cherry 7054-60 (CH)	WR	 Fog 961-58 (Formica)	FF
		WRITABLE LAMINATE HASKELL CODE	
		Frosty White 949-90 (Formica) (available on Echo™ series only) consult price list for upcharge for writable surface	F9









wood grain 3mm edge options: Assemble, Echo™, Fuzion™, Smart, Marathon, Market Desking

COLOR	HASKELL CODE
 Asian Night W7949	AN
 Fusion Maple W7909-2009	I
 Grey Elm W8201	GE
 Harvest Maple W7953	MH
 Montana Walnut W7110	OW
 Natural Rift W7954	RT
 Neo Walnut W7991	NW
 Summer Flame (matches wild cherry) TL420-2009	SM

solid 3mm edge options: Assemble, Echo™, Fuzion™, Smart, Marathon, Market Desking

COLOR	HASKELL CODE
 Black W1595	A
 Fog F961	FG
 Grey W1500	B
 Orange Grove WD501	OG
 Pepperdust WD327	G
 Primary Yellow PTSY914	PY
 Slate Grey WD91	F
 Spectrum Blue F8515	SB
 Spectrum Red F845	SR

paint color options: Captiva™, Smart, Marathon, Market Desking & Storage

PAINT COLOR	HASKELL CODE	PAINT COLOR	HASKELL CODE
 Arctic Gray 5019	AG	 Smoke 5066	SM
 Black 5002	BK		
 Brownstone 5064	BR		
 Graphite 5925	28		
 Pacifica 5083	PF		
 Platinum	P2		
 Platinum* 5055	PL		
 Powder Beige 5025	BG		
*PL is smooth the rest are textured			

paint color options: Explorer frame color options

PAINT COLOR	HASKELL CODE
 Green Apple	GA
 Navy	EN
 Platinum	P2

Finish Guide









paint color options: Explorer storage module color options

PAINT COLOR	HASKELL CODE
Platinum *PL is smooth the rest are textured	P2

paint color options: Echo™ & Fuzion™

PAINT COLOR	HASKELL CODE
Platinum *PL is smooth the rest are textured	PL







Ethos shell color options

PLASTIC COLOR	HASKELL CODE	PLASTIC COLOR	HASKELL CODE	PLASTIC COLOR	HASKELL CODE
 Navy	8J	 Sky	8D	 Green Apple	8E
 Orange	8F	 Storm	8L	 Black	8A
 Purple	8I	 Red	8B		

Ethos base color options

PLASTIC COLOR	HASKELL CODE
 Storm	8L
 Black	8A

tackboard fabric options: Smart & Market Desking

ANCHORAGE	2335
 Asteroid (2053)	AS
 Cobalt Blue (2045)	
 Geranium ((2084)	AN
 Green Olive (2048)	97
 Quarry Blue (2026)	96
 Waterfall (2691)	95

BROADCAST	2758
 Graphite (2375)	GR

1. If you require physical paint, edge or plastic samples, please contact Haskell customer support at 800-344-8888 or sales@haskelloffice.com.
2. If you require physical laminate samples please contact our laminate partner directly: Wilsonart at 800-433-3222.
3. If you require physical fabric samples please contact our textile partner directly: Guilford of Maine at 800-544-0200.
4. Please note: If you select a finish that is not listed above, there will be a custom finish upcharge and additional LEAD TIME* may apply.
5. A textured finish is standard for Haskell paint; the only exception is Platinum that comes in a smooth finish.*

Notes & Planning

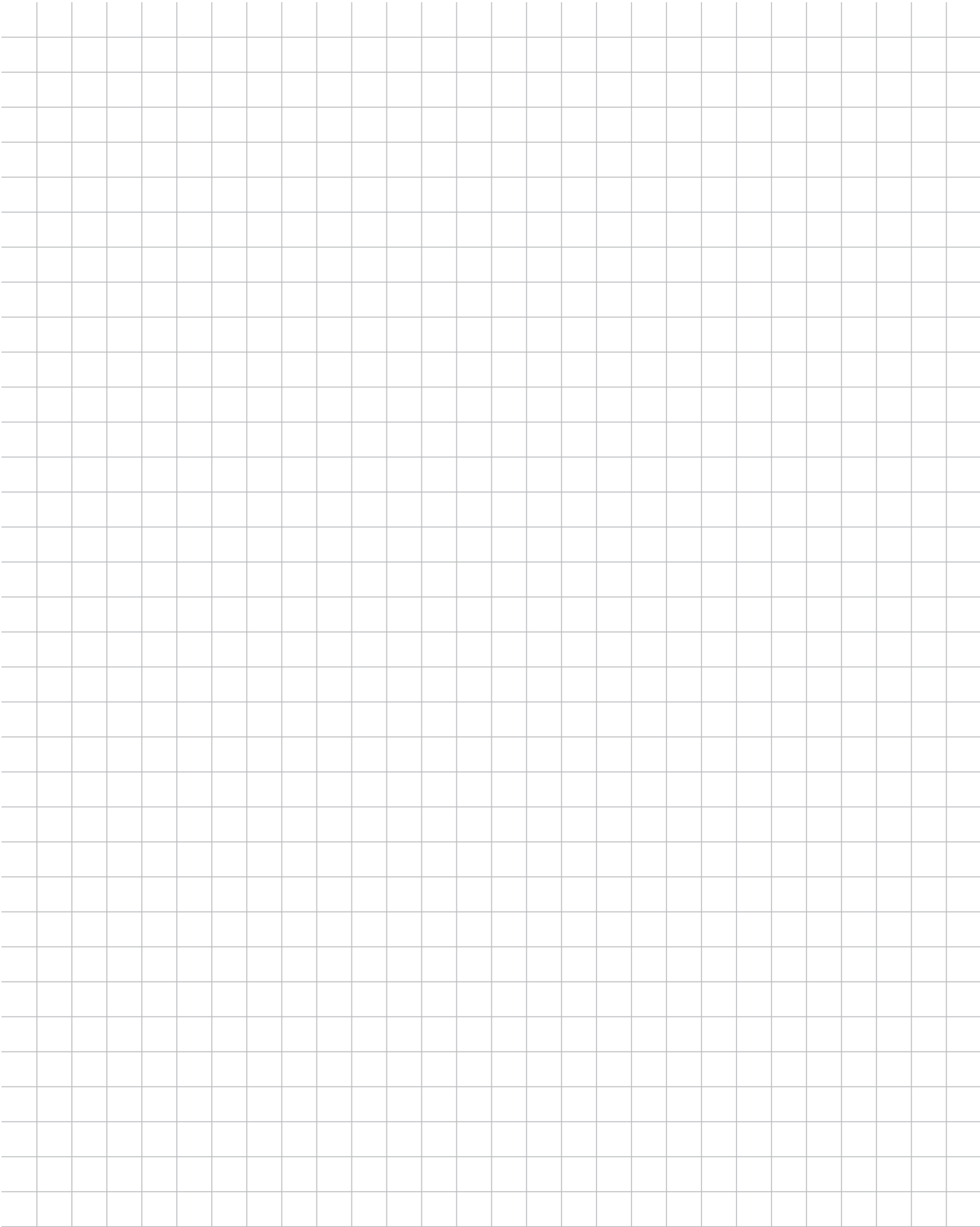
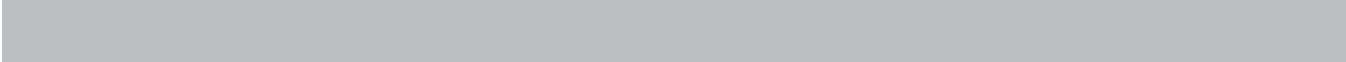

360 series

introduction



General

Designed with simplicity in mind, the 360 Chair is anything but simple. Packed into the sleek frame are a multitude of features all designed to enhance the total experience of students, teachers, and facilities staff alike. With its breadth of line, the 360 Chair meets the rigorous needs of today's learning environments while enhancing student engagement and supporting great design.

Base Options

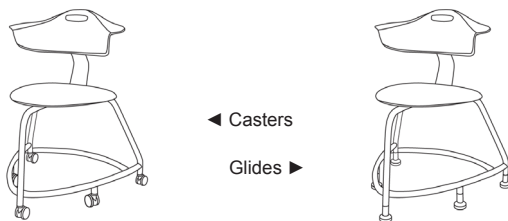

Bookbag Rack

Optional bookbag rack allows easy access for storage of backpacks and personal items.

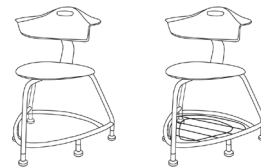

Heights





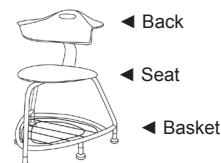

Color Notation

Choose colors for the chair, seat, back and optional bookbag rack.

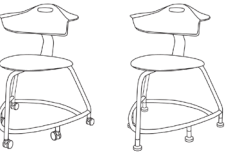
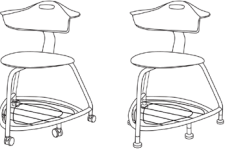
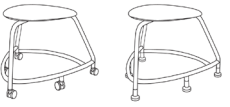

360 Series

Chair

DESCRIPTION	ITEM #	NOTES	D	W	H	PRICE	SHIP WT.	LEAD TIME*
360 3 legged chair with back, 18"h Platinum frame. Available Glides Only		TS0G0.18PL glides only	23.5	26	31.25	\$372	18	S
360 3 legged chair without back, 18"h Platinum frame. Available Glides only		TS3G0.18PL glides only	23.5	26	18	\$294	13	S
360 chair with back without bookbag rack, 18"h. Platinum frame.		TS1G0.18PL glides	23.5	26	31.25	\$384	23	S
		TS1CHW0.18PL hard wheel casters for carpeted surfaces				\$384	23	S
		TS1CSW0.18PL soft wheel casters for hard surfaces				\$406	23	S
360 chair with back with bookbag rack, 18"h. Platinum frame.		TS1G1.18PL glides	23.5	26	31.25	\$424	26	S
		TS1CHW1.18PL hard wheel casters for carpeted surfaces				\$424	26	S
		TS1CSW1.18PL soft wheel casters for hard surfaces				\$446	26	S
360 chair without back without bookbag rack, 18"h. Platinum frame.		TS2G0.18PL glides	23.5	26	18	\$306	18	S
		TS2CHW0.18PL hard wheel casters for carpeted surfaces				\$306	18	S
		TS2CSW0.18PL soft wheel casters for hard surfaces				\$328	18	S
360 chair without back with bookbag rack, 18"h. Platinum frame.		TS2G1.18PL glides	23.5	26	18	\$338	20	S
		TS2CHW1.18PL hard wheel casters for carpeted surfaces				\$338	20	S
		TS2CSW1.18PL soft wheel casters for hard surfaces				\$360	20	S

to order

1. Item Number
2. Size/Frame Color
3. Bookbag Rack
4. Seat Finish
5. Back Finish

example

TS1CHW1 - 18PL - TR - 8B - 8B

ITEM NUMBER SIZE/FRAME COLOR BOOKBAG RACK SEAT FINISH BACK FINISH

please separate each item with a dot

seat/back finish options

CODE	DESCRIPTION
8A	Black
8B	Red
8D	Sky
8E	Green Apple
8F	Orange
8I	Purple
8J	Navy
8L	Storm

bookbag rack finish options

CODE	DESCRIPTION
TS	Storm
TR	Red
TN	Navy
TG	Green Apple

frame paint finish

CODE	DESCRIPTION
8A	Platinum (only option)

360 Series

360 Series - fabric planner

For Purchase Order Number:

Project Name:

Headboard: 1 Linear Yard

Fabric Manufacturer:

Fabric Pattern:

Fabric Color:

Seat: 2 Linear Yards

Fabric Manufacturer:

Fabric Pattern:

Fabric Color:

Seat: 1 Linear Yard

Fabric Manufacturer:

Fabric Pattern:

Fabric Color:

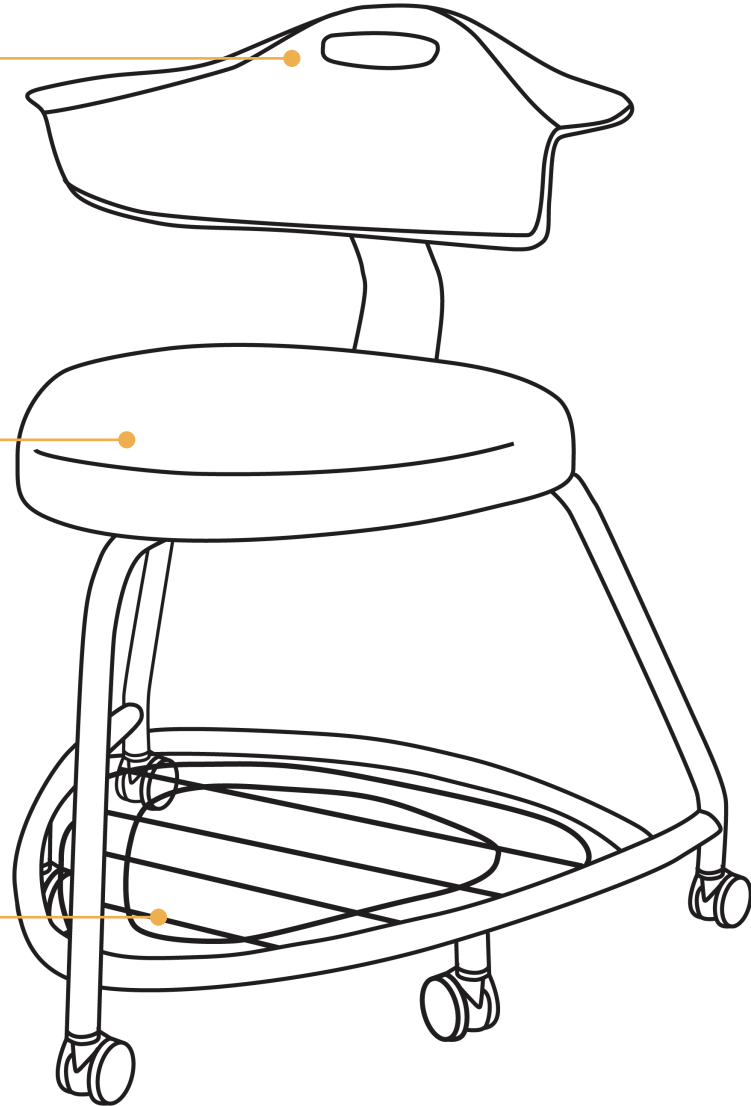

Yardage requirements are for non-railroaded upholstery. Please contact customer service for railroading requirements or repeats over 2 inches.

This form must accompany your order. Send completed form to sales@haskelloffice.com

The lead-time of your order is directly related to when the COM fabric is received.

Please ship COM to: Haskell, 3770 Hagen Dr., Wyoming, MI 49548

Clearly label all materials with the dealer name, project name, and purchase order number.

[Download the COM Fabric Planner for 360 Series](#)

360 Series

Upholstered Chair

DESCRIPTION	ITEM #	NOTES	D	W	H	COM PRICE	SHIP WT.	LEAD TIME*
360 3 legged chair with back, 18"h Platinum frame. Available Glides Only	UTS0G0.18PL	glides only	23.5	26	31.25	\$472	18	S
360 3 legged chair without back, 18"h Platinum frame. Available Glides only	UTS3G0.18PL	glides only	23.5	26	18	\$394	13	S
360 chair with back without bookbag rack, 18"h. Platinum frame.	UTS1G0.18PL	glides	23.5	26	31.25	\$484	23	S
	UTS1CHW0.18PL	hard wheel casters for carpeted surfaces				\$484	23	S
	UTS1CSW0.18PL	soft wheel casters for hard surfaces				\$506	23	S
360 chair with back with bookbag rack, 18"h. Platinum frame.	UTS1G1.18PL	glides	23.5	26	31.25	\$524	26	S
	UTS1CHW1.18PL	hard wheel casters for carpeted surfaces				\$524	26	S
	UTS1CSW1.18PL	soft wheel casters for hard surfaces				\$546	26	S
360 chair without back without bookbag rack, 18"h. Platinum frame.	UTS2G0.18PL	glides	23.5	26	18	\$406	18	S
	UTS2CHW0.18PL	hard wheel casters for carpeted surfaces				\$406	18	S
	UTS2CSW0.18PL	soft wheel casters for hard surfaces				\$428	18	S
360 chair without back with bookbag rack, 18"h. Platinum frame.	UTS2G1.18PL	glides	23.5	26	18	\$438	20	S
	UTS2CHW1.18PL	hard wheel casters for carpeted surfaces				\$438	20	S
	UTS2CSW1.18PL	soft wheel casters for hard surfaces				\$460	20	S

to order

1. Item Number
2. Size/Frame Color
3. Bookbag Rack
4. Seat Finish
5. Back Finish

example

TS1CHW1 - 18PL - TR - 8B - 8B

ITEM NUMBER SIZE/FRAME COLOR BOOKBAG RACK SEAT FINISH BACK FINISH

please separate each item with a dot

back finish options

CODE	DESCRIPTION
8A	Black
8B	Red
8D	Sky
8E	Green Apple
8F	Orange
8I	Purple
8J	Navy
8L	Storm

bookbag rack finish options









CODE	DESCRIPTION
TS	Storm
TR	Red
TN	Navy
TG	Green Apple

frame paint finish

CODE	DESCRIPTION
PL	Platinum (only option)

360 Series

Stool

DESCRIPTION	ITEM #	NOTES	D	W	H	PRICE	SHIP WT.	LEAD TIME*
360 stool with back, without bookbag rack, 24"h. Platinum frame.	 TS4G0.24PL	glides	23.5	26	37.25	\$448	25	S
	 TS4CHW0.24PL	hard wheel casters for carpeted surfaces				\$448	25	S
	TS4CSW0.24PL	soft wheel casters for hard surfaces				\$470	25	S
360 stool with back, with bookbag rack, 24"h. Platinum frame.	 TS4G1.24PL	glides	23.5	26	37.25	\$480	27	S
	 TS4CHW1.24PL	hard wheel casters for carpeted surfaces				\$480	27	S
	TS4CSW1.24PL	soft wheel casters for hard surfaces				\$502	27	S
360 stool without back or bookbag rack, 24"h. Platinum frame.	 TS5G0.24PL	glides	23.5	26	24	\$364	22	S
	 TS5CHW0.24PL	hard wheel casters for carpeted surfaces				\$364	22	S
	TS5CSW0.24PL	soft wheel casters for hard surfaces				\$386	22	S
360 stool without back, with bookbag rack, 24"h. Platinum frame.	 TS5G1.24PL	glides	23.5	26	24	\$388	22	S
	 TS5CHW1.24PL	hard wheel casters for carpeted surfaces				\$388	22	S
	TS5CSW1.24PL	soft wheel casters for hard surfaces				\$410	22	S

to order	<ol style="list-style-type: none"> 1. Item Number 2. Size/Frame Color 3. Bookbag Rack 4. Seat Finish 5. Back Finish 	example	<p>TS1CHW1 - 18PL - TR - 8B - 8B</p> <p>ITEM NUMBER SIZE/FRAME COLOR BOOKBAG RACK SEAT FINISH BACK FINISH</p> <p><i>please separate each item with a dot</i></p>
----------	--	---------	---

seat/back finish options

CODE	DESCRIPTION
8A	Black
8B	Red
8D	Sky
8E	Green Apple
8F	Orange
8I	Purple
8J	Navy
8L	Storm

bookbag rack finish options

CODE	DESCRIPTION
TS	Storm
TR	Red
TN	Navy
TG	Green Apple

frame paint finish

CODE	DESCRIPTION
PL	Platinum (only option)

360 Series

Stool

DESCRIPTION	ITEM #	NOTES	D	W	H	PRICE	SHIP WT.	LEAD TIME*
360 stool with back, without bookbag rack, 30"h. Platinum frame.	TS4G0.30PL	glides	23.5	26	43.25	\$464	28	S
	TS4CC0.30PL	compression casters				\$644	28	S
360 stool with back, with bookbag rack, 30"h. Platinum frame.	TS4G1.30PL	glides	23.5	26	43.25	\$494	30	S
	TS4CC1.30PL	compression casters				\$674	30	S
360 stool without back or bookbag rack, 30"h. Platinum frame.	TS5G0.30PL	glides	23.5	26	30	\$382	23	S
	TS5CC0.30PL	compression caster				\$562	23	S
360 stool without back, with bookbag rack, 30"h. Platinum frame.	TS5G1.30PL	glides	23.5	26	30	\$402	25	S
	TS5CC1.30PL	compression caster				\$582	25	S

to order

1. Item Number
2. Size/Frame Color
3. Bookbag Rack
4. Seat Finish
5. Back Finish

example

TS1CHW1 - 18PL - TR - 8B - 8B

ITEM NUMBER SIZE/FRAME COLOR BOOKBAG RACK SEAT FINISH BACK FINISH

please separate each item with a dot

seat/back finish options

CODE	DESCRIPTION
8A	Black
8B	Red
8D	Sky
8E	Green Apple
8F	Orange
8I	Purple
8J	Navy
8L	Storm

bookbag rack finish options



CODE	DESCRIPTION
TS	Storm
TR	Red
TN	Navy
TG	Green Apple

frame paint finish

CODE	DESCRIPTION
PL	Platinum (only option)

360 Series

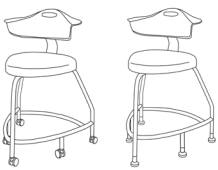
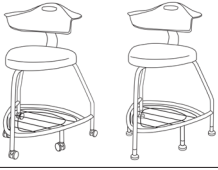
Upholstered Stool

DESCRIPTION	ITEM #	NOTES	D	W	H	COM PRICE	SHIP WT.	LEAD TIME*
360 stool with back, without bookbag rack, 24"h. Platinum frame. 	UTS4G0.24PL	glides	23.5	26	37.25	\$548	25	S
	UTS4CHW0.24PL	hard wheel casters for carpeted surfaces				\$548	25	S
	UTS4CSW0.24PL	soft wheel casters for hard surfaces				\$570	25	S
360 stool with back, with bookbag rack, 24"h. Platinum frame. 	UTS4G1.24PL	glides	23.5	26	37.25	\$580	27	S
	UTS4CHW1.24PL	hard wheel casters for carpeted surfaces				\$580	27	S
	UTS4CSW1.24PL	soft wheel casters for hard surfaces				\$602	27	S
360 stool without back or bookbag rack, 24"h. Platinum frame. 	UTS5G0.24PL	glides	23.5	26	24	\$464	22	S
	UTS5CHW0.24PL	hard wheel casters for carpeted surfaces				\$464	22	S
	UTS5CSW0.24PL	soft wheel casters for hard surfaces				\$486	22	S
360 stool without back, with bookbag rack, 24"h. Platinum frame. 	UTS5G1.24PL	glides	23.5	26	24	\$488	22	S
	UTS5CHW1.24PL	hard wheel casters for carpeted surfaces				\$488	22	S
	UTS5CSW1.24PL	soft wheel casters for hard surfaces				\$510	22	S

to order	<ol style="list-style-type: none"> 1. Item Number 2. Size/Frame Color 3. Bookbag Rack 4. Seat Finish 5. Back Finish 	example	TS1CHW1 - 18PL - TR - 8B - 8B <small>ITEM NUMBER SIZE/FRAME COLOR BOOKBAG RACK SEAT FINISH BACK FINISH</small> <small>please separate each item with a dot</small>
----------	--	---------	---

back finish options

CODE	DESCRIPTION
8A	Black
8B	Red
8D	Sky
8E	Green Apple
8F	Orange
8I	Purple
8J	Navy
8L	Storm

bookbag rack finish options

CODE	DESCRIPTION
TS	Storm
TR	Red
TN	Navy
TG	Green Apple

frame paint finish

CODE	DESCRIPTION
PL	Platinum (only option)

360 Series

Upholstered Stool

DESCRIPTION	ITEM #	NOTES	D	W	H	COM PRICE	SHIP WT.	LEAD TIME*
360 stool with back, without bookbag rack, 30"h. Platinum frame.	UTS4G0.30PL	glides	23.5	26	43.25	\$564	28	S
	UTS4CC0.30PL	compression casters				\$744	28	S
360 stool with back, with bookbag rack, 30"h. Platinum frame.	UTS4G1.30PL	glides	23.5	26	43.25	\$594	30	S
	UTS4CC1.30PL	compression casters				\$774	30	S
360 stool without back or bookbag rack, 30"h. Platinum frame.	UTS5G0.30PL	glides	23.5	26	30	\$482	23	S
	UTS5CC0.30PL	compression caster				\$662	23	S
360 stool without back, with bookbag rack, 30"h. Platinum frame.	UTS5G1.30PL	glides	23.5	26	30	\$502	25	S
	UTS5CC1.30PL	compression caster				\$682	25	S

to order

1. Item Number
2. Size/Frame Color
3. Bookbag Rack
4. Seat Finish
5. Back Finish

example

TS1CHW1 - 18PL - TR - 8B - 8B

ITEM NUMBER SIZE/FRAME COLOR BOOKBAG RACK SEAT FINISH BACK FINISH

please separate each item with a dot

back finish options

CODE	DESCRIPTION
8A	Black
8B	Red
8D	Sky
8E	Green Apple
8F	Orange
8I	Purple
8J	Navy
8L	Storm

bookbag rack finish options

CODE	DESCRIPTION
TS	Storm
TR	Red
TN	Navy
TG	Green Apple

frame paint finish

CODE	DESCRIPTION
PL	Platinum (only option)

Assemble Series

introduction



General





All Assemble Series Tables are 29" H. Worksurfaces are laminate wood core tops at 1 3/16" thick and are available with 3mm and wood edges on select models. Assemble Series Tables offers a variety of legs styles including tubular, C-tubular, arc, path and disk base. Caster, modesty panels, folding legs, and nesting options are available on select models.

Electrical Options

Assemble Series Tables offer an extensive collection of electrical options including power/data modules, grommets, and vertical/horizontal wire management. Contact customer service for a detailed quotation.

Assemble Series

conferencing & multi-purpose tables

DESCRIPTION	ITEM #	NOTES	D	W	H	(T) TUBULAR	(A) ARC	(D) DISC	(P) PATH	LEAD TIME*
						BASE	BASE	BASE	BASE	
						3MM	3MM	3MM	3MM	
 Round table w/ glides	ASH(x)-30RD	X-BASE for (T) & (A)	30"		29"	\$914	N/A	\$1198	N/A	S
	ASH(x)-36RD	X-BASE for (T) & (A)	36"		29"	\$978	\$1038	\$1258	N/A	S
	ASH(x)-42RD	X-BASE for (T) & (A)	42"		29"	\$1120	\$1160	\$1478	N/A	S
	ASH(x)-48RD	X-BASE for (T) & (A)	48"		29"	\$1314	\$1368	\$1628	N/A	S
	ASH(x)-60RD	X-BASE for (T) & (A)	60"		29"	\$1738	N/A	N/A	N/A	S
 Square table w/ glides	ASH(x)-3030SQ	X-BASE for (T) & (A)	30"	30"	29"	\$958	\$1058	\$1198	N/A	S
	ASH(x)-3636SQ	X-BASE for (T) & (A)	36"	36"	29"	\$1038	\$1120	\$1258	N/A	S
	ASH(x)-4242SQ	X-BASE for (T) & (A)	42"	42"	29"	\$1,68	\$11268	\$1478	N/A	S
	ASH(x)-4848SQ	X-BASE for (T) & (A)	48"	48"	29"	\$1658	N/A	\$1628		S
	ASH(x)-6060SQ	X-BASE for (T) & (A)	60"	60"	29"	\$1738	N/A	N/A	N/A	
 Racetrack Table w/ tubular base & glides	ASH(x)-3660RT		36"	60"	29"	\$1264	\$1264	\$2298	\$1398	S
	ASH(x)-3672RT		36"	72"	29"	\$1328	\$1324	\$2408	\$1448	S
	ASH(x)-3684RT		36"	84"	29"	\$1368	\$1398	\$2434	\$1478	S
 Bowed (boat) table w/ glides	ASH(x)-3696BT		36" Ends 42" Middle	96"	29"	\$1498	\$1428	\$2848	\$1628	S

to order

1. Item Number - replace the (?) with the base code
2. Paint Finish - (MS) metallic silver or (BK) Black
3. Laminate
4. Edge Finish
5. Options

example

ASHT-30RD	MS	FF	FG	WO1G
ITEM NUMBER	PAINT	LAMINATE	EDGE	OPTIONS

please separate each item with a dot

wire management options



MODEL	DESCRIPTION	PRICE
WO1G	(1) Grommet, centered on table worksurface	\$58
WO36	36" Wire Manager, Field Trimmable	\$132
WO48	48" Wire Manager, Field Trimmable	\$144
WO60	60" Wire Manager, Field Trimmable	\$162
WO72	72" Wire Manager, Field Trimmable	\$172
WOC5	Cable Spine	\$430

power & data options

MODEL	DESCRIPTION	PRICE
POPM	Plastic power module (2) power (2) data jacks, centered on worksurface	\$390
POAM	Aluminum power module (2) power (2) data jacks, centered on worksurface	\$625

Assemble Series

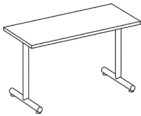
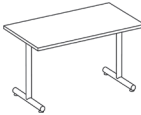
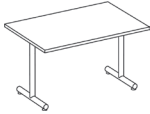
training tables

DESCRIPTION	ITEM #	NOTES	D	W	H	(T) TUBULAR	(TC) C-TUBULAR	(A) ARC	(P) PATH	LEAD TIME*
						BASE	BASE	BASE	BASE	
						3mm	3mm	3mm	3mm	
24" Deep Training table w/ glides 	ASH(x)-2430		24"	30"	29"	\$834	\$834	\$838	N/A	S
	ASH(x)-2436		24"	36"	29"	\$854	\$854	\$858	N/A	S
	ASH(x)-2442		24"	42"	29"	\$878	\$878	\$882	N/A	S
	ASH(x)-2448		24"	48"	29"	\$918	\$918	\$938	N/A	S
	ASH(x)-2454		24"	54"	29"	\$994	\$994	\$1024	N/A	S
	ASH(x)-2460		24"	60"	29"	\$1048	\$1048	\$1078	N/A	S
	ASH(x)-2466		24"	66"	29"	\$1078	\$1078	\$1108	N/A	S
ASH(x)-2472		24"	72"	29"	\$1110	\$1110	\$1140	N/A	S	
30" Deep Training table w/ glides 	ASH(x)-3030		30"	30"	29"	\$1030	\$1030	\$1060	N/A	S
	ASH(x)-3036		30"	36"	29"	\$1038	\$1038	\$1068	N/A	S
	ASH(x)-3042		30"	42"	29"	\$1046	\$1046	\$1076	N/A	S
	ASH(x)-3048		30"	48"	29"	\$1052	\$1052	\$1082	N/A	S
	ASH(x)-3054		30"	54"	29"	\$1074	\$1074	\$1104	N/A	S
	ASH(x)-3060		30"	60"	29"	\$1128	\$1128	\$1158	\$1170	S
	ASH(x)-3066		30"	66"	29"	\$1143	\$1143	\$1178	\$1200	S
ASH(x)-3072		30"	72"	29"	\$1158	\$1158	\$1198	\$1248	S	
36" Deep Training table w/ glides 	ASH(x)-3636		36"	36"	29"	\$978	\$978	\$998	N/A	S
	ASH(x)-3642		36"	42"	29"	\$998	\$998	\$1,008	N/A	S
	ASH(x)-3648		36"	48"	29"	\$1038	\$1038	\$1058	N/A	S
	ASH(x)-3660		36"	60"	29"	\$1162	\$1162	\$1182	\$1358	S
	ASH(x)-3666		36"	66"	29"	\$1204	\$1204	\$1224	\$1398	S
ASH(x)-3672		36"	72"	29"	\$1256	\$1256	\$1276	\$1410	S	
24" Deep Transitional Training Worksurface 	ASH(x)Q-2424		24"	24"		\$325	\$325	\$325	N/A	S
Trapezoid Training Table w/ glides 	ASHT(?) -2448		24"	48"	29"	\$948	\$948	\$948	N/A	S
	ASHT(?) -3060		30"	60"	29"	\$1208	\$1208	\$1208	N/A	S

to order

1. Item Number - replace the (?) with the base code
2. Paint Finish - (MS) metallic silver or (BK) Black
3. Laminate
4. Edge Finish
5. Options

example

ASHT-2448	MS	FF	FG	WO1G
ITEM NUMBER	PAINT	LAMINATE	EDGE	OPTIONS
<i>please separate each item with a dot</i>				

wire management options

MODEL	DESCRIPTION	PRICE
WO1G	(1) Grommet, centered on table worksurface	\$58
WO2G	(2) Grommets, (1) in each worksurface corner, approach side	\$126
WO36	36" Wire Manager, Field Trimmable	\$132
WO48	48" Wire Manager, Field Trimmable	\$144
WO60	60" Wire Manager, Field Trimmable	\$162
WO72	72" Wire Manager, Field Trimmable	\$172
WOCS	Cable Spine	\$430

power & data options

MODEL	DESCRIPTION	PRICE
POPM	Plastic power module (2) power (2) data jacks, centered on worksurface	\$390
POAM	Aluminum power module (2) power (2) data jacks, centered on worksurface	\$625





base options

MODEL	DESCRIPTION	PRICE
BOCS	Casters, table heights remain the same	\$230
BOGC	Ganging clips	\$114
BO36	36" Modesty Panel	\$150
BO48	48" Modesty Panel	\$162
BO60	60" Modesty Panel	\$168
BO72	72" Modesty Panel	\$178

[Return to Table of Contents](#)

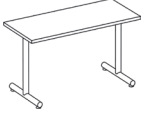
Assemble Series

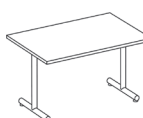
training tables

DESCRIPTION	ITEM #	NOTES	D	W	H	(BONL) FLIP/NESTING BASE WITH CASTERS	LEAD TIME*
						3MM	
 24" Deep Training table	ASHBONL-2448		24"	48"	29"	\$1,398	S
	ASHBONL-2454		24"	54"	29"	\$1,474	S
	ASHBONL-2460		24"	60"	29"	\$1,528	S
	ASHBONL-2466		24"	66"	29"	\$1,558	S
	ASHBONL-2472		24"	72"	29"	\$1,590	S
 30" Deep Training table	ASHBONL-3048		30"	48"	29"	\$1,532	S
	ASHBONL-3054		30"	54"	29"	\$1,554	S
	ASHBONL-3060		30"	60"	29"	\$1,608	S
	ASHBONL-3066		30"	66"	29"	\$1,623	S
	ASHBONL-3072		30"	72"	29"	\$1,638	S
 36" Deep Training table	ASHBONL-3648		36"	48"	29"	\$1,518	S
	ASHBONL-3654		36"	54"	29"	\$1,580	S
	ASHBONL-3660		36"	60"	29"	\$1,642	S
	ASHBONL-3666		36"	66"	29"	\$1,684	S
	ASHBONL-3672		36"	72"	29"	\$1,736	S
 Trapezoid Training Table	ASHTBONL-2448		24"	48"	29"	\$1,428	S
	ASHTBONL-3060		30"	60"	29"	\$1,688	S

to order

1. Item Number - replace the (?) with the base code
2. Paint Finish - (MS) metallic silver or (BK) Black
3. Laminate
4. Edge Finish
5. Options

example

ASHBONL-2448 MS FF WO1G
 ITEM NUMBER PAINT LAMINATE OPTIONS
 please separate each item with a dot

wire management options

MODEL	DESCRIPTION	PRICE
WO1G	(1) Grommet, centered on table worksurface	\$58
WO2G	(2) Grommets, (1) in each worksurface corner, approach side	\$126
WO36	36" Wire Manager, Field Trimmable	\$132
WO48	48" Wire Manager, Field Trimmable	\$144
WO60	60" Wire Manager, Field Trimmable	\$162
WO72	72" Wire Manager, Field Trimmable	\$172
WOCS	Cable Spine	\$430

power & data options

MODEL	DESCRIPTION	PRICE
POPM	Plastic power module (2) power (2) data jacks, centered on worksurface	\$390
POAM	Aluminum power module (2) power (2) data jacks, centered on worksurface	\$625

Captiva™ Series

introduction - pedestals



Pedestals shown with full, recessed and loop pulls. Full pulls only are available.

General

All Captiva™ Pedestals are 14 7/8" in width. All file drawers are designed to accommodate hanging folders. Mobile units are standard with counterweights to reduce the likelihood of tipping. However, it is recommended that not more than one heavily loaded drawer be opened at one time. Caution should be exercised when pedestals are used as freestanding units.

Assembly

All units ship fully assembled.

Locks

Captiva™ Pedestals come standard with a removable core lock for easy reconfiguration on site. Units can be keyed alike to other Haskell Products upon request.

Unit Construction

The Captiva™ Series Pedestal drawer fronts are external to the case and are referred to as Proud.

Wood Core Tops

Laminate tops are available as a separate component. Tops are available with a 3mm edge. All wood core tops are 1 1/8" thick.

Casters/Glides

Captiva™ Pedestals are available with either adjustable glides or casters. Casters and glides are easily interchangeable in the field.

COM

All COM yardage is based on a 54" wide fabric.

Keying Information and Locking Options

All locks feature a removable core which is easily removed on site. All lock cores are interchangeable through all products as cores are universal.

Locks throughout an order or locks within a particular workstation can be keyed alike at no additional charge if specified when ordering. Keyed Alike means that all locks are identical. To order, specify which products are to be keyed alike and order a "Removable Core Lock Kit" for each group of products to be keyed alike. The specified products will be shipped without lock cores. The cores for each workstation will be packaged separately. All Removable Core Lock Kits are shipped with a control key for removing or inserting lock cores. Note that a control key works only when a lock is in the unlocked position.



Master keys, which operate any removable core lock, are available for \$35 net each.

One control key is provided for each "key alike" order. If additional keys are needed, cost is \$35 net each.

Additional keys can be purchased for \$15 net per key.

Captiva™ Series

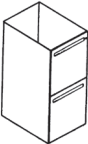
workspace supporting and fixed pedestals w/ proud drawers

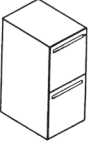
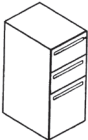
DESCRIPTION	ITEM #	D	W	H	PRICE	SHIP WT.	LEAD TIME*
Worksurface Supporting Pedestals file/file, open top 	WP18FF	17 1/4"	14 7/8"	27 5/8"	\$734	85	E
	WP24FF	22 7/8"	14 7/8"	27 5/8"	\$744	85	E
	WP28FF	28 7/8"	14 7/8"	27 5/8"	\$830	85	E
Worksurface Supporting Pedestals box/box/file, open top 	WP18BBF	17 1/4"	14 7/8"	27 5/8"	\$754	88	E
	WP24BBF	22 7/8"	14 7/8"	27 5/8"	\$764	88	E
	WP28BBF	28 7/8"	14 7/8"	27 5/8"	\$850	88	E
Fixed Pedestal file/file 	FP18FF	17 1/4"	14 7/8"	27 5/8"	\$760	87	E
	FP24FF	22 7/8"	14 7/8"	27 5/8"	\$770	87	E
	FP28FF	28 7/8"	14 7/8"	27 5/8"	\$856	87	E
Fixed Pedestal box/box/file 	FP18BBF	17 1/4"	14 7/8"	27 5/8"	\$780	83	E
	FP24BBF	22 7/8"	14 7/8"	27 5/8"	\$790	83	E
	FP28BBF	28 7/8"	14 7/8"	27 5/8"	\$876	83	E

to order

1. Item Number
2. Pull Style
3. Paint Finish

example

WP18FF - FL - 5503
ITEM NUMBER PULL STYLE PAINT FINISH
please separate each item with a dash

drawer pull options

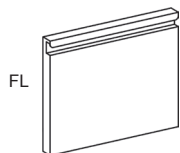

MODEL DESCRIPTION

FL Full

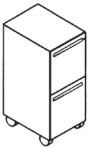
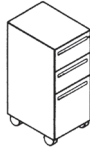

Captiva™ Series

mobile pedestals w/ proud drawers

DESCRIPTION	ITEM #	COM	D	W	H	PRICE	SHIP WT.	LEAD TIME*
Mobile Pedestal w/ casters file/file 	MP18FF		17 ¼"	14 ⅞"	27 ½"	\$868	83	E
	MP24FF		22 ⅞"	14 ⅞"	27 ½"	\$928	83	E
	MP28FF		28 ⅞"	14 ⅞"	27 ½"	\$988	83	E
Mobile Pedestal w/ casters box/box/file 	MP18BBF		17 ¼"	14 ⅞"	27 ½"	\$878	87	E
	MP24BBF		22 ⅞"	14 ⅞"	27 ½"	\$938	87	E
	MP28BBF		28 ⅞"	14 ⅞"	27 ½"	\$1004	87	E
Mobile Pedestal cushion top & zeal casters box/file 	ZMPF24BF	1 YD	22 ⅞"	14 ⅞"	24 ½"	\$1168	80	E
Mobile Pedestal metal top & zeal casters box/file 	ZMP24BF	1 YD	22 ⅞"	14 ⅞"	23 ⅞"	\$868	80	E

to order 1. Item Number 2. Pull Style 3. Paint Finish 4. Fabric (for cushion top pedestal only)	example MP18FF - FL - 5503 - <small>ITEM NUMBER PULL STYLE PAINT FINISH FABRIC</small> <i>please separate each item with a dash</i>
--	---

drawer pull options

MODEL	DESCRIPTION
FL	Full

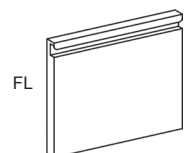

notes

- Pedestals come with the following:
- 2 keys
 - Pencil Tray
 - Side-Side / Front-Back Filing

Captiva™ Series

pedestals accessories

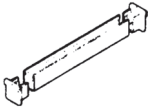
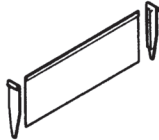
DESCRIPTION	ITEM #	SIZE/DESCRIPTION	PRICE	SHIP WT.	LEAD TIME*
 Pedestal Side to Side Bar	OHASFB	Allows users to file letter or legal width files side to side	\$40		
 Pedestal Drawer Divider	OHABDD	For box drawers	\$78		
File Compressor	OHCOMP	File drawer compressor	\$58		

to order

1. Item Number

example

OHASFB
ITEM NUMBER

Captiva™ Series

introduction - lateral files & storage cabinets



General

All Captiva™ Lateral Files are constructed using Haskell's unique "Double O" frame construction for outstanding strength and durability. Captiva™ Lateral Files and Overfile units are 18" deep. Adjustable glides are standard at the front and rear of all cases. Files are designed with dual lock bars and safety interlock mechanisms integrated into the suspensions. All standard lateral files with fixed front drawers come with a set of hanging folder frames for side-to-side filing. Two dividers can be substituted for side-to-side rails at no charge if specified when ordering. Front-to-back filing bars may be ordered separately for field installation. All drawer fronts are field replaceable.

Suspensions

All Captiva™ Lateral Files have heavy duty, fully progressive steel ball bearing suspensions with integrated slide lock system. The integrated slide lock system has the interlock built into the drawer slide to enable a more positive interlock system.

Assembly

All units ship fully assembled. Interior drawer accessories are field-installed only.

Locks

Captiva™ Laterals come standard with a removable core lock for easy reconfiguration on site. Units can be keyed alike to other Haskell Products upon request.

Wood Core Tops

Laminate tops are available as a separate component to span multiple files. Tops are available with a 3mm edge. All wood core tops are 1 1/8" thick.

Unit Construction

The Captiva™ Series Laterals are offered with flush style drawer fronts.

Keying Information and Locking Options

All locks feature a removable core which is easily removed on site. All lock cores are interchangeable through all products as cores are universal.

Locks throughout an order or locks within a particular workstation can be keyed alike at no additional charge if specified when ordering. "Keyed Alike" means that all locks are identical. To order, specify which products are to be keyed alike and order a "Removable Core Lock Kit" for each group of products to be keyed alike. The specified products will be shipped without lock cores. The cores for each workstation will be packaged separately. All Removable Core Lock Kits are shipped with a control key for removing or inserting lock cores. Note that a control key works only when a lock is in the unlocked position.

Master keys, which operate any removable core lock, are available for \$35 net each.

One control key is provided for each "key alike" order. If additional keys are needed, cost is \$35 net each.

Additional keys can be purchased for \$15 net per key.

Captiva™ Series

lateral files w/ 12" flush drawers

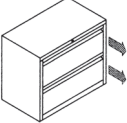
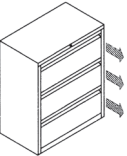
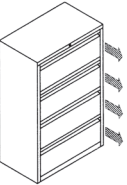
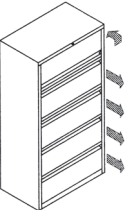
DESCRIPTION	ITEM #	D	W	H	PRICE	SHIP WT.	LEAD TIME*
Two High (2) 12" flush drawers 	LA12F-3024-2D	18"	30"	28"	\$1408	103	E
	LA12F-3624-2D	18"	36"	28"	\$1570	119	E
	LA12F-4224-2D	18"	42"	28"	\$1774	134	E
Three High (3) 12" flush drawers 	LA12F-3036-3D	18"	30"	40"	\$1880	143	E
	LA12F-3636-3D	18"	36"	40"	\$2020	162	E
	LA12F-4236-3D	18"	42"	40"	\$2134	181	E
Four High (4) 12" flush drawers 	LA12F-3048-4D	18"	30"	52"	\$2494	182	E
	LA12F-3648-4D	18"	36"	52"	\$2978	205	E
	LA12F-4248-4D	18"	42"	52"	\$2964	227	E
Five High (4) 12" flush drawers & (1) 12" receding door w/ roll out shelf 	LA12F-3060-4D1R	18"	30"	64"	\$2764	221	E
	LA12F-3660-4D1R	18"	36"	64"	\$3194	248	E
	LA12F-4260-4D1R	18"	42"	64"	\$3294	274	E

to order

1. Item Number
2. Pull Style
3. Paint Finish

example

LA12F-3024-2D - FL - 5503

ITEM NUMBER PULL STYLE PAINT FINISH

please separate each item with a dash

drawer pull options

MODEL DESCRIPTION



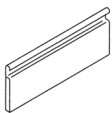

FL Full

FL



Captiva™ Series

storage lockers

DESCRIPTION	ITEM #	D	W	H	PRICE	SHIP WT.	LEAD TIME*
2 Tier Locker with Legs (INDV DIM: 12W x 18D x 30H)	LK2121866L	18"	12"	66"	\$3240	180	E
							
2 Tier Locker with Legs (INDV DIM: 12W x 18D x 36H)	LK2121878L	18"	12"	78"	\$3348	182	E
							
4 Tier Locker with Legs (INDV DIM: 15W x 18D x 18H)	LK415181878	18"	15"	78"	\$2302	190	E
							
2 Tier 3 Lockers Per Horizontal Row (Total 6 Indv Lockers) with Legs (INDV DIM: 15W x 18D x 36H)	LK615183678	18"	45"	78"	\$2302	385	E
							

to order	1. Item Number	LK2121866L	-	5503
	2. Paint Finish	ITEM NUMBER		PAINT FINISH
		<i>please separate each item with a dash</i>		

drawer pull

MODEL DESCRIPTION

FL Full

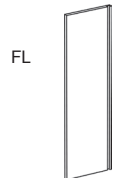

Captiva™ Series

storage lockers

DESCRIPTION	ITEM #	D	W	H	PRICE	SHIP WT.	LEAD TIME*
Individual Locker with Legs, 4 Coat Hooks, Coat Rod and Shelf 	LK4121266L	12"	12"	66"	\$3020	177	E
	LK4121278L	12"	12"	78"	\$3104	191	E
	LK4121866L	18"	12"	66"	\$3430	188	E
	LK4121566L	15"	12"	66"	\$2896	182	E
	LK4121578L	15"	12"	78"	\$3430	196	E
	LK4182178P	18"	12"	78"	\$2368	202	E

15-Door Cell Phone Locker with Individual Label Holder and Lock	CPL243115	9"	24"	31"	\$2808	85	E
---	-----------	----	-----	-----	--------	----	---

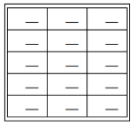

25-Door Cell Phone Locker with Individual Label Holder and Lock	CPL243125	9"	36"	31"	\$3078	121	E
---	-----------	----	-----	-----	--------	-----	---

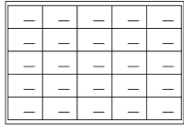

36-Door Cell Phone Locker with Individual Label Holder and Lock	CPL243136	9"	28"	78"	\$3298	304	E
---	-----------	----	-----	-----	--------	-----	---



to order
1. Item Number
2. Paint Finish

example **LK4121266L - 5503**
ITEM NUMBER PAINT FINISH
please separate each item with a dash

drawer pull

MODEL DESCRIPTION

FL Full

FL



Captiva™ Series

heavy duty storage

DESCRIPTION	ITEM #	D	W	H	PRICE	SHIP WT.	LEAD TIME*
Industrial Shelving w/ adjustable Shelves	SU362475-6 (6) Adjustable Shelves	24"	48"	75"	\$2646	121	E
	SU361887-8 (8) Adjustable Shelves	18"	36"	87"	\$2742	133	E



Industrial Cabinet w/ adjustable Shelves	SU362487-8 Closed Storage No Doors (8) Adjustable Shelves	24"	36"	87"	\$2940	243	E
	SU361878-6 (6) Adjustable Shelves	18"	36"	78"	\$3062	261	E

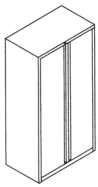

to order

1. Item Number
2. Paint Finish

See paint finish options below

example SU362475-6 - 26

ITEM NUMBER PAINT FINISH

please separate each item with a dash

drawer pull

MODEL	DESCRIPTION
FL	Full

FL



paint finish options

MODEL	DESCRIPTION
26	Soft Gray

Captiva™ Series

lateral files laminate tops

DESCRIPTION	ITEM NUMBER	NOTE	D	W	3MM EDGE	SHIP WT.	LEAD TIME*
Laminate Tops	HKLFT1830	For (1) 30" W lateral file	18"	30"	\$312	18	E
	HKLFT1836	For (1) 36" W lateral file	18"	36"	\$348	20	E
	HKLFT1842	For (1) 42" W lateral file	18"	42"	\$358	25	E
	HKLFT1860	For (2) 30" W lateral files	18"	60"	\$414	35	E
	HKLFT1872	For (2) 36" W lateral files	18"	72"	\$498	42	E
	HKLFT1884	For (2) 42" W lateral files	18"	84"	\$568	49	E

to order

1. Item Number
2. Laminate
3. Edge Finish

example

HKLFT1830 - HS - 4072
ITEM NUMBER LAMINATE EDGE FINISH
please separate each item with a dash

Captiva™ Series

lateral files accessories

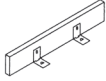
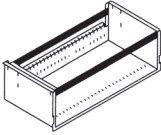
DESCRIPTION	ITEM #	NOTE	PRICE	SHIP WT.	LEAD TIME*
Metal Counter Weight 	CWF	For use with any size lateral or vertical file	\$248	20	E
Flush Hanging Bars front-to-back	FBS/18-2-F	Sold as set, one set required per drawer. For use in any size lateral file	\$88	1	E
Flush Hanging Bars side-to-side 	SSS-30-F	For 30" W drawers	\$88	1	E
	SSS-36-F	For 36" W drawers	\$88	1	E
	SSS-42-F	For 42" W drawers	\$88	1	E
Proud Hanging Bars front-to-back	FBS/18-2-P	Sold as set, one set required per drawer. For use in any size lateral file	\$88	1	E
Proud Hanging Bars side-to-side	SSS-30-P	For 30" W drawers	\$88	1	E
	SSS-36-P	For 36" W drawers	\$88	1	E
	SSS-42-P	For 42" W drawers	\$88	1	E

to order

1. Item Number

example

CWF
ITEM NUMBER

Captiva™ Series

introduction - vertical files



General

All Captiva™ Vertical Files are constructed using Haskell's unique "Double O" frame construction for outstanding strength and durability. Captiva™ Vertical Files are 28" in exterior depth with an interior filing capacity of 25 ½" and each unit ships with a spring loaded mechanical compressor in each drawer. Captiva™ Vertical Files come standard with the Haskell S.I.S.™ safety interlock system integrated within each slide, allowing only one drawer to open at a time. All vertical files are available in 14 ¾" (letter) or 17 ¾" (legal) widths. Adjustable glides are standard at the front and rear of all cases and all files drawers have been designed to accommodate hanging folders.

Suspensions:

All Captiva™ Vertical Files have heavy duty, fully progressive steel ball bearing suspensions with integrated slide lock system.

Assembly

All units ship fully assembled. Interior drawer accessories are field-installed only.

Locks

Captiva™ Vertical Files come standard with a removable core lock for easy reconfiguration on site. Units can be keyed alike to other Haskell Products upon request.

Unit Construction

The Captiva™ Series Vertical drawer fronts are external to the case and are referred to as Proud.

Wood Core Tops

Laminate tops are available as a separate component to span one to four files. Tops are available with a 3mm edge. All wood core tops are 1 ⅞" thick.

Keying Information and Locking Options

All locks feature a removable core which is easily removed on site. All lock cores are interchangeable through all products as cores are universal.

Locks throughout an order or locks within a particular workstation can be keyed alike at no additional charge if specified when ordering. Keyed Alike means that all locks are identical. To order, specify which products are to be keyed alike and order a "Removable Core Lock Kit" for each group of products to be keyed alike. The specified products will be shipped without lock cores. The cores for each workstation will be packaged separately. All Removable Core Lock Kits are shipped with a control key for removing or inserting lock cores. Note that a control key works only when a lock is in the unlocked position.



Master keys, which operate any removable core lock, are available for \$35 net each.

One control key is provided for each "key alike" order. If additional keys are needed, cost is \$35 net each.

Additional keys can be purchased for \$15 net per key.

Captiva™ Series

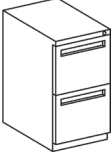
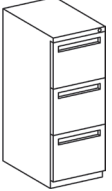
letter width vertical file w/ proud drawers

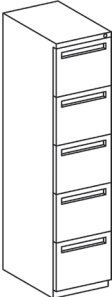
DESCRIPTION	ITEM #	D	W	H	PRICE	SHIP WT.	LEAD TIME*
Letter Two High 	HVFR2	28"	14 3/4"	28"	\$998	72	E
Letter Three High 	HVFR3	28"	14 3/4"	40"	\$1468	98	E
Letter Four High 	HVFR4	28"	14 3/4"	52"	\$1828	125	E
Letter Five High 	HVFR5	28"	14 3/4"	64"	\$2048	148	E

to order

1. Item Number
2. Pull Style
3. Paint Finish

example HVFR2 - FL - 5503

ITEM NUMBER PULL STYLE PAINT FINISH

please separate each item with a dash

drawer pull options

MODEL	DESCRIPTION
FL	Full

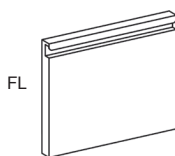

Captiva™ Series

vertical files laminate tops

DESCRIPTION	ITEM NUMBER	NOTE	D	W	3MM EDGE	SHIP WT.	LEAD TIME*
Laminate Tops for letter width files	HKVF1428	For (1) letter width file	28 ¾"	14 1/16"	\$218	12	E
	HKVF2928	For (2) letter width files	28 ¾"	30"	\$304	22	E
	HKVF4328	For (3) letter width files	28 ¾"	45 7/8"	\$378	32	E
	HKVF5828	For (4) letter width files	28 ¾"	60"	\$448	42	E

to order

1. Item Number
2. Laminate
3. Edge Finish

example

HKVF1428 - HS - 4072

ITEM NUMBER LAMINATE EDGE FINISH

please separate each item with a dash

Captiva™ Series

introduction - bookcases



General

All Captiva™ Bookcases are 14" in exterior depth and are available in three standard widths 30", 36" and 42". Captiva™ Bookcases have 2 height options 27 5/8", 42". Adjustable glides are standard at the front and rear of all cases.

Shelf Configuration

All Captiva™ Bookcases have (1) fixed bottom shelf.

- 27 5/8" high bookcases have (1) adjustable shelf.
- 42" high bookcases have (2) adjustable shelves.

Each Adjustable shelf includes 4 clips to position the shelf at customer's preference. Additional shelves are available.

Assembly

All units ship fully assembled.

Installation

Correct installation should include proper leveling and ganging of multiple units.

Wood Core Tops

Laminate tops are available as a separate component. Tops are available with a 3mm edge. All wood core tops are 1 1/8" thick.

Captiva™ Series

bookcases

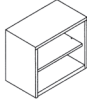
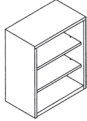
DESCRIPTION	ITEM #	NOTE	D	W	H	PRICE	SHIP WT.	LEAD TIME*
Bookcase, 27 5/8"H (1) adjustable shelf 	BC215-30		14"	30"	27 5/8"	\$798	40	E
	BC215-36		14"	36"	27 5/8"	\$878	46	E
	BC215-42		14"	42"	27 5/8"	\$928	52	E
Bookcase, 42"H (2) adjustable shelves 	BC315T-36		14"	36"	42"	\$1038	68	E
Adjustable Shelves (4) clips	HFBC3015SH	For 30" W bookcase	14"	30"		\$162	5	E
	HFBC3615SH	For 36" W bookcase	14"	36"		\$168	5	E
	HFBC4215SH	For 42" W bookcase	14"	42"		\$182	5	E
Shelf Divider	SD9-2PACK			8"	7 1/2"	\$148	12	E

to order

1. Item Number
2. Paint Finish

example

BC215-30 - 5503

ITEM NUMBER PAINT FINISH

please separate each item with a dash

Captiva™ Series

bookcases laminate tops

DESCRIPTION	ITEM NUMBER	NOTE	D	W	3MM EDGE	SHIP WT.	LEAD TIME*
Laminate Tops for bookcases	HKBCT1430	For 30" W bookcase	14"	30"	\$276	20	E
	HKBCT1436	For 36" W bookcase	14"	36"	\$304	24	E
	HKBCT1442	For 42" W bookcase	14"	42"	\$338	28	E

to order

1. Item Number
2. Laminate
3. Edge Finish

example

HKBCT1430 - HS - 4072

ITEM NUMBER LAMINATE EDGE FINISH

please separate each item with a dash

Disco series

introduction



General

A sophisticated active learning stool that supports multiple body types and sizes allowing students to pivot, spin and rock in a 360-degree motion. When you hear the word disco, it conjures thoughts of movement, energy and having fun. At the same time, the Latin meaning for the word disco is “I Learn.” It’s the perfect pairing of meanings. Learning at its core should be energized and fun. And we know that simply being able to move during class time is a big part of that equation.

Disco Series

Stool

DESCRIPTION	ITEM #	NOTES	D	W	H	PRICE	SHIP WT.	LEAD TIME*
Disco active learning stool. Platinum frame, Storm base	DS1.18		18	18	18	\$334	19	S

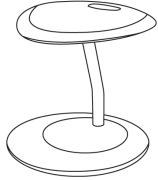

to order

1. Item Number (replace xx with caster option where applicable)
 2. Size (18" only)
 3. Paint (Platinum only)
 4. Seat Finish

example

DS1 - 18 - PL - 8B

ITEM NUMBER Size Paint Seat Finish

please separate each item with a dash

shell finish options

CODE	DESCRIPTION
8A	Black
8B	Red
8D	Sky
8E	Green Apple
8F	Orange
8I	Purple
8J	Navy
8L	Storm

Frame Finish Option

CODE	DESCRIPTION
P2	Platinum

Disco Series

Stool - fabric planner

For Purchase Order Number:

Project Name:

Seat: 2 Linear Yards

Fabric Manufacturer:

Fabric Pattern:

Fabric Color:

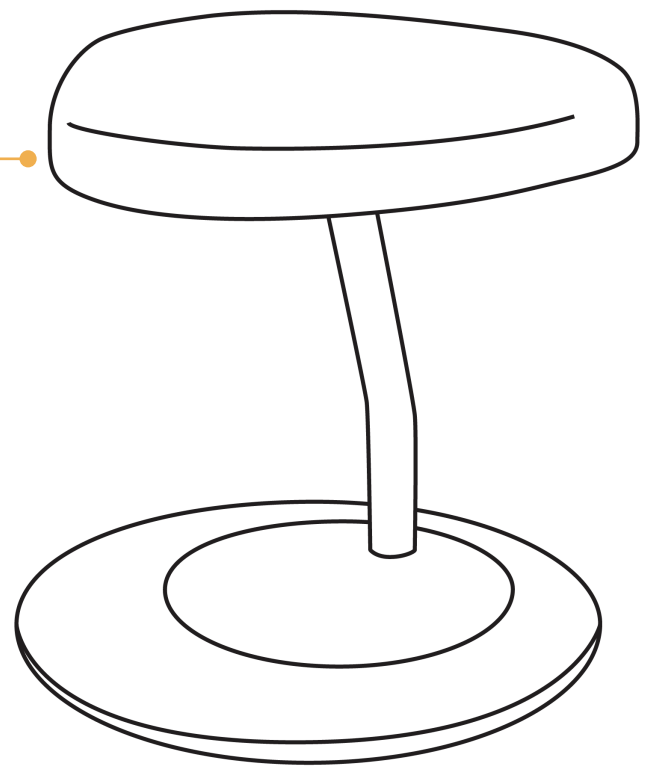

to order

example

Yardage requirements are for non-railroaded upholstery. Please contact customer service for railroading requirements or repeats over 2 inches.

This form must accompany your order. Send completed form to sales@haskelloffice.com

The lead-time of your order is directly related to when the COM fabric is received.

Please ship COM to: Haskell, 3770 Hagen Dr., Wyoming, MI 49548

Clearly label all materials with the dealer name, project name, and purchase order number.

[Download the COM Fabric Planner for Disco Stool](#)

Disco Series

Upholstered Stool

DESCRIPTION	ITEM #	NOTES	D	W	H	PRICE	SHIP WT.	LEAD TIME*
Disco active learning stool. Platinum frame, Storm base	UDS1.18		18	18	18	\$434	19	S

to order

example

1. Item Number (replace xx with caster option where applicable)
 2. Size (18" only)
 3. Paint (Platinum only)
 4. Seat Finish

DS1 - 18 - PL - COM

ITEM NUMBER Size Paint Seat Finish

please separate each item with a dash

Seat option

CODE	DESCRIPTION
COM	Upholstered

Frame Finish Option

CODE	DESCRIPTION
P2	Platinum

Echo™ Series

introduction





General

The Echo™ Series educator desks are 29" H, worksurfaces are laminate wood core tops at 1 3/8" thick and are available with a 3mm edge. Echo™ Series legs are offered in a standard Platinum paint finish.

Echo™ Series

individual student desk

DESCRIPTION	ITEM #	D	W	H	Standard Laminate	F9 (WRITEABLE)	SHIP WT.	LEAD TIME*
					3MM EDGE	3MM EDGE		
Echo™ 22" Deep Rectangular Individual Student Desk w/ Echo™ base & caster 	3ECH01.2226.PL	22"	26"	29"	\$684	\$754	60	S
Echo™ 24" Deep Rectangular Individual Student Desk w/ Echo™ base & casters 	3ECH01.2434.PL	24"	34"	29"	\$730	\$838	60	S
Echo™ 24" Deep Keystone Individual Student Desk w/ Echo™ base & casters 	3ECH09.2434.PL	22"	34"	29"	\$730	\$838	60	S

to order	1. Item Number	example	3ECH01.2226.PL - GL - FG
	2. Laminate		ITEM NUMBER LAMINATE EDGE FINISH
	3. Edge Finish		<i>please separate each item with a dot</i>

top options (list as separate lines on your order)

MODEL	DESCRIPTION	PRICE
3BOMC	Magnetic Clips (not to be used with side hooks)	\$82
3BOTDH2	Side Hooks (2) and Side Docks (2) (Offered in (PL) Platinum)	\$104
BTMP22	22" Modesty panel (to be used on a 34"w or 39"w table)	\$104
BOF1	(1) Grommet with device and cupholder **Not available on 3ECH01.2226 PL	\$58

paint finish options



MODEL	DESCRIPTION	LEAD TIME
PL	Platinum	Standard 4-6 weeks

pin height adjustable leg options

MODEL	DESCRIPTION	PRICE
ADA Compliant 24" to 35" (Add A in front of item #)	\$230	
Standing Height 28" to 41" (Add SH in front of item #)	\$230	

Echo™ Series

individual student desk

DESCRIPTION	ITEM #	D	W	H	Standard Laminate	F9 (WRITEABLE)	SHIP WT.	LEAD TIME*
					3MM EDGE	3MM EDGE		
Echo 22" Deep Rectangular Individual Student Desk w/ Echo base, glides (1 side) & locking casters (1 side)	3ECH02.2226.PL	22"	26"	29"	\$670	\$772	60	S
								
Echo 24" Deep Rectangular Individual Student Desk w/ Echo base, glides (1 side) & locking casters (1 side)	3ECH02.2434.PL	24"	34"	29"	\$716	\$838	60	S
								
Echo 24" Deep Keystone Individual Student Desk w/ Echo base, glides (1 side) & locking casters (1 side)	3ECH09W.2434.	24"	34"	29"	\$716	\$838	60	S
								

to order

1. Item Number
2. Laminate
3. Edge Finish

example

3ECH01.2226.PL - GL - FG

ITEM NUMBER LAMINATE EDGE FINISH

please separate each item with a dot

top options (list as separate lines on your order)

MODEL	DESCRIPTION	PRICE
3BOMC	Magnetic Clips (not to be used with side hooks)	\$82
3BOTDH2	Side Hooks (2) and Side Docks (2) (Offered in (PL) Platinum)	\$104
BTMP22	22" Modesty panel (to be used on a 34"w or 39"w table)	\$104
BOF1	(1) Grommet with device and cupholder **Not available on 3ECH01.2226 PL	\$58

paint finish options

MODEL	DESCRIPTION	LEAD TIME
PL	Platinum	Standard 4-6 weeks

pin height adjustable leg options

MODEL	DESCRIPTION	PRICE
ADA Compliant 24" to 35" (Add A in front of item #)	\$230	
Standing Height 28" to 41" (Add SH in front of item #)	\$230	

Echo™ Series

individual student desk

DESCRIPTION	ITEM #	D	W	H	Standard Laminate	F9 (WRITEABLE)	SHIP WT.	LEAD TIME*
					3MM EDGE	3MM EDGE		
Echo 22" Deep Rectangular Individual Student Desk w/ Echo base & glides	3ECH03.2226.PL	22"	26"	29"	\$664	\$766	60	S



Echo 24" Deep Rectangular Individual Student Desk w/ Echo base & glides	3ECH03.2434.PL	24"	34"	29"	\$710	\$832	60	S
---	----------------	-----	-----	-----	-------	-------	----	---



Echo 24" Deep Keystone Individual Student Desk w/ Echo base & glides	3ECH09G.2434.	24"	34"	29"	\$710	\$832	60	S
--	---------------	-----	-----	-----	-------	-------	----	---



DESCRIPTION	ITEM #		D	W	H	PRICE	SHIP WT.	LEAD TIME*
Personal Marker Board (item sold separately)	MB2318H	Marker board trim offered in Gray (8M) Magnets can be used with marker boards	1"	23"	18"	\$224	6	S

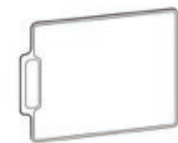

to order

- Item Number
- Laminate
- Edge Finish

example 3ECH01.2226.PL - GL - FG
ITEM NUMBER LAMINATE EDGE FINISH
please separate each item with a dot

top options (list as separate lines on your order)

MODEL	DESCRIPTION	PRICE
3BOMC	Magnetic Clips (not to be used with side hooks)	\$82
3BOTDH2	Side Hooks (2) and Side Docks (2) (Offered in (PL) Platinum)	\$104
BTMP22	22" Modesty panel (to be used on a 34"w or 39"w table)	\$104
BOF1	(1) Grommet with device and cupholder **Not available on 3ECH01.2226 PL	\$58

paint finish options





MODEL	DESCRIPTION	LEAD TIME
PL	Platinum	Standard 4-6 weeks

pin height adjustable leg options

MODEL	DESCRIPTION	PRICE
ADA Compliant 24" to 35" (Add A in front of item #)	\$230	
Standing Height 28" to 41" (Add SH in front of item #)	\$230	

Echo™ Series

19" deep rectangular training and teaming tables

DESCRIPTION	ITEM #	NOTES	D	W	H	Standard Laminate	F9 (WRITEABLE)	SHIP WT.	LEAD TIME*
						3MM EDGE	3MM EDGE		
Echo™ 19" Deep Rectangular Training Table w/ Echo™ base & locking casters 	3ECH01.1939.PL		19"	39"	29"	\$698	\$768	56	S
	3ECH01.1948.PL		19"	48"	29"	\$728	\$802	63	S
	3ECH01.1960.PL		19"	60"	29"	\$820	\$912	75	S
	3ECH01.1966.PL		19"	66"	29"	\$940	\$1036	78	S
	3ECH01.1972.PL		19"	72"	29"	\$984	\$1094	82	S
	3ECH01.1984.PL		19"	84"	29"	\$1064	\$1194	94	S
Echo™ 19" Deep Rectangular Training Table w/ Echo™ base, glides (1 side) and locking casters (1 side) 	3ECH02.1939.PL		19"	39"	29"	\$686	\$756	56	S
	3ECH02.1948.PL		19"	48"	29"	\$716	\$790	63	S
	3ECH02.1960.PL		19"	60"	29"	\$808	\$900	75	S
	3ECH02.1966.PL		19"	66"	29"	\$928	\$1024	78	S
	3ECH02.1972.PL		19"	72"	29"	\$972	\$1082	82	S
	3ECH02.1984.PL		19"	84"	29"	\$1052	\$1182	94	S
Echo™ 19" Deep Rectangular Training Table w/ Echo™ base & glides 	3ECH03.1939.PL		19"	39"	29"	\$674	\$744	56	S
	3ECH03.1948.PL		19"	48"	29"	\$704	\$778	63	S
	3ECH03.1960.PL		19"	60"	29"	\$896	\$988	75	S
	3ECH03.1966.PL		19"	66"	29"	\$916	\$1012	78	S
	3ECH03.1972.PL		19"	72"	29"	\$960	\$1070	82	S
	3ECH03.1984.PL		19"	84"	29"	\$1040	\$1170	94	S
DESCRIPTION	ITEM #	NOTES	D	W	H	PRICE		SHIP WT.	LEAD TIME*
Personal Marker Board (item sold separately) 	MB2318H	Marker board trim offered in Gray (8M) Magnets can be used with marker boards	1"	23"	18"	\$224		6	S

to order
1. Item Number
2. Laminate
3. Edge Finish

example **3ECH01.1939.PL - GL - FG**
ITEM NUMBER LAMINATE EDGE FINISH
 please separate each item with a dot

top options (list as separate lines on your order)

MODEL	DESCRIPTION	PRICE
3BOMC	Magnetic Clips (not to be used with side hooks)	\$82
3BOTDH2	Side Hooks (2) and Side Docks (2) (Offered in (PL) Platinum)	\$104
3BOTDH	Side Hooks (2), Center Dock (1) and Side Docks(2) (Offered in (PL) Platinum * for use on 60"w and up	\$104
3BODH	Back pack hooks (2)	\$82
BTMP22	22" Modesty panel (to be used on a 34"w or 39"w table)	\$104
BTMP32	32" Modesty Panel (to be used on a 48"w table)	\$122
BTMP43	43" Modesty Panel (to be used on a 60"w or 66"w table)	\$140
BTMP55	55" Modesty Panel (to be used on a 72"w or 84"w table)	\$164

paint finish options





MODEL	DESCRIPTION	LEAD TIME
PL	Platinum	Standard 4-6 weeks

pin height adjustable leg options

DESCRIPTION	PRICE
ADA Compliant 24" to 35" (Add A in front of item #)	\$230
Standing Height 28" to 41" (Add SH in front of item #)	\$230

Echo™ Series

24" deep rectangular training and teaming tables

DESCRIPTION	ITEM #	NOTES	D	W	H	Standard Laminate	F9 (WRITEABLE)	SHIP WT.	LEAD TIME*
						3MM EDGE	3MM EDGE		
Echo™ 24" Deep Rectangular Training Table w/ Echo™ base & locking casters 	3ECH01.2439.PL		24"	39"	29"	\$768	\$848	68	S
	3ECH01.2448.PL		24"	48"	29"	\$844	\$930	70	S
	3ECH01.2460.PL		24"	60"	29"	\$920	\$1024	84	S
	3ECH01.2466.PL		24"	66"	29"	\$960	\$1068	90	S
	3ECH01.2472.PL		24"	72"	29"	\$980	\$1102	94	S
	3ECH01.2484.PL		24"	84"	29"	\$1108	\$1268	108	S
Echo™ 24" Deep Rectangular Training Table w/ Echo™ base, glides (1 side) & locking casters (1 side) 	3ECH02.2439.PL		24"	39"	29"	\$754	\$834	68	S
	3ECH02.2448.PL		24"	48"	29"	\$830	\$916	70	S
	3ECH02.2460.PL		24"	60"	29"	\$906	\$1010	84	S
	3ECH02.2466.PL		24"	66"	29"	\$946	\$1054	90	S
	3ECH02.2472.PL		24"	72"	29"	\$966	\$1088	94	S
	3ECH02.2484.PL		24"	84"	29"	\$1094	\$1254	108	S
Echo™ 24" Deep Rectangular Training Table w/ Echo™ base & glides 	3ECH03.2439.PL		24"	39"	29"	\$748	\$828	68	S
	3ECH03.2448.PL		24"	48"	29"	\$824	\$910	70	S
	3ECH03.2460.PL		24"	60"	29"	\$898	\$1002	84	S
	3ECH03.2466.PL		24"	66"	29"	\$940	\$1048	90	S
	3ECH03.2472.PL		24"	72"	29"	\$960	\$1082	94	S
	3ECH03.2484.PL		24"	84"	29"	\$1088	\$1248	108	S
DESCRIPTION	ITEM #	NOTES	D	W	H			SHIP WT.	LEAD TIME*
Personal Marker Board (item sold separately) 	MB2318H	Marker board trim offered in Gray (8M) Magnets can be used with marker boards	1"	23"	18"	\$224		6	S

to order

- Item Number
- Laminate
- Edge Finish

example

3ECH01.2439.PL - GL - FG
ITEM NUMBER LAMINATE EDGE FINISH

please separate each item with a dot

top options (list as separate lines on your order)

MODEL	DESCRIPTION	PRICE
3BOMC	Magnetic Clips (not to be used with side hooks)	\$82
3BOTDH2	Side Hooks (2) and Side Docks (2) (Offered in (PL) Platinum)	\$104
3BOTDH	Side Hooks (2), Center Dock (1) and Side Docks(2) (Offered in (PL) Platinum * for use on 60"w and up)	\$104
3BODH	Back pack hooks (2)	\$82
BTMP22	22" Modesty panel (to be used on a 34"w or 39"w table)	\$104
BTMP32	32" Modesty Panel (to be used on a 48"w table)	\$122
BTMP43	43" Modesty Panel (to be used on a 60"w or 66"w table)	\$140
BTMP55	55" Modesty Panel (to be used on a 72"w or 84"w table)	\$164
BOF1	(1) Grommet with device holder and cupholder.	\$58
BOF2	(2) Grommet with device holder and cupholder. (2 will fit on 24x60 or wider)	\$116

paint finish options



MODEL	DESCRIPTION	LEAD TIME
PL	Platinum	Standard 4-6 weeks

pin height adjustable leg options

MODEL	PRICE
ADA Compliant 24" to 35" (Add A in front of item #)	\$230
Standing Height 28" to 41" (Add SH in front of item #)	\$230

Echo™ Series

30" deep rectangular training and teaming tables

DESCRIPTION	ITEM #	NOTES	D	W	H	Standard Laminate	F9 (WRITEABLE)	SHIP WT.	LEAD TIME*
						3MM EDGE	3MM EDGE		
Echo™ 30" Deep Rectangular Training Table w/ Echo™ base & locking casters 	3ECH01.3048.PL		30"	48"	29"	\$880	\$984	80	S
	3ECH01.3060.PL		30"	60"	29"	\$960	\$1084	95	S
	3ECH01.3066.PL		30"	66"	29"	\$1008	\$1150	102	S
	3ECH01.3072.PL		30"	72"	29"	\$1056	\$1200	106	S
	3ECH01.3084.PL		30"	84"	29"	\$1164	\$1328	122	S
Echo™ 30" Deep Rectangular Training Table w/ Echo™ base, glides (1 side) & locking casters (1 side) 	3ECH02.3048.PL		30"	48"	29"	\$876	\$980	80	S
	3ECH02.3060.PL		30"	60"	29"	\$946	\$1070	95	S
	3ECH02.3066.PL		30"	66"	29"	\$994	\$1136	102	S
	3ECH02.3072.PL		30"	72"	29"	\$1042	\$1186	106	S
	3ECH02.3084.PL		30"	84"	29"	\$1150	\$1314	122	S
Echo™ 30" Deep Rectangular Training Table w/ Echo™ base & glides 	3ECH03.3048.PL		30"	48"	29"	\$866	\$970	80	S
	3ECH03.3060.PL		30"	60"	29"	\$932	\$1056	95	S
	3ECH03.3066.PL		30"	66"	29"	\$982	\$1124	102	S
	3ECH03.3072.PL		30"	72"	29"	\$1030	\$1174	106	S
	3ECH03.3084.PL		30"	84"	29"	\$1138	\$1302	122	S

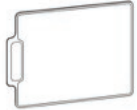
DESCRIPTION	ITEM #	NOTES	D	W	H	PRICE	SHIP WT.	LEAD TIME*
Personal Marker Board (item sold separately) 	MB2318H	Marker board trim offered in Gray (8M) Magnets can be used with marker boards	1"	23"	18"	\$224	6	S

to order

- Item Number
- Laminate
- Edge Finish

example

3ECH01.3048.PL - GL - FG
ITEM NUMBER LAMINATE EDGE FINISH

please separate each item with a dot

top options (list as separate lines on your order)

MODEL	DESCRIPTION	PRICE
3BOMC	Magnetic Clips (not to be used with side hooks)	\$82
3BOTDH2	Side Hooks (2) and Side Docks (2) (Offered in (PL) Platinum)	\$104
3BOTDH	Side Hooks (2), Center Dock (1) and Side Docks(2) (Offered in (PL) Platinum * for use on 60"w and up	\$104
3BODH	Back pack hooks (2)	\$82
BTMP22	22" Modesty panel (to be used on a 34"w or 39"w table)	\$104
BTMP32	32" Modesty Panel (to be used on a 48"w table)	\$104
BTMP43	43" Modesty Panel (to be used on a 60"w or 66"w table)	\$140
BTMP55	55" Modesty Panel (to be used on a 72"w or 84"w table)	\$164
BOF1	(1) Grommet with device holder and cupholder.	\$58
BOF2	(2) Grommet with device holder and cupholder. (2 will fit on 30x60 or wider)	\$116

paint finish options



MODEL	DESCRIPTION	LEAD TIME
PL	Platinum	Standard 4-6 weeks

pin height adjustable leg options

MODEL	PRICE
ADA Compliant 24" to 35" (Add A in front of item #)	\$230
Standing Height 28" to 41" (Add S in front of item #)	\$230

Echo™ Series

Shape training and teaming tables

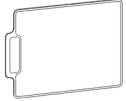
DESCRIPTION	ITEM #	NOTE	D	W	H	Standard Laminate	F9 (WRITEABLE)	SHIP WT.	LEAD TIME*
						3MM EDGE	3MM EDGE		
HALF ROUND									
Echo™ Half Round Training Table w/ Echo™ base & locking casters	3ECH01.2448HR.PL		24"	48"	29"	\$918	\$1022	70	S
	3ECH01.3060HR.PL		30"	60"	29"	\$1092	\$1216	95	S
									
Echo™ Half Round Training Table w/ Echo™ base, glides (1 side) & locking casters (1 side)	3ECH02.2448HR.PL		24"	48"	29"	\$904	\$1008	70	S
	3ECH02.3060HR.PL		30"	60"	29"	\$1076	\$1200	95	S
									
Echo™ Half Round Training Table w/ Echo™ base & glides	3ECH03.2448HR.PL		24"	48"	29"	\$892	\$996	70	S
	3ECH03.3060HR.PL		30"	60"	29"	\$1064	\$1188	95	S
									
DESCRIPTION	ITEM #	NOTES	D	W	H	PRICE	SHIP WT.	LEAD TIME*	
Personal Marker Board (item sold separately)	MB2318H	Marker board trim offered in Gray (8M) Magnets can be used with marker boards	1"	23"	18"	\$224	6	S	
									

to order

1. Item Number
2. Laminate
3. Edge Finish

example

3ECH01.2448HR.PL - GL - FG

ITEM NUMBER

Laminate

Edge

please separate each item with a dot

pin height adjustable leg options

DESCRIPTION	MODEL	PRICE	DESCRIPTION	LEAD TIME
ADA Compliant 24" to 35" (Add "A" in front of item #)	PL	\$230	Platinum	Standard 4-6 weeks
Standing Height 28" to 41" (Add "SH" in front of item #)		\$230		



paint finish options

S - Standard Lead Time 4-6 weeks (Lead times subject to change without notice)

* Lead time based on paint finishes noted above / S - Standard Lead Time 4-6 weeks (Lead times subject to change without notice)

Echo™ Series

19" deep chevron training and teaming tables

DESCRIPTION	ITEM #	NOTES	D	W	H	Standard Laminate	F9 (WRITEABLE)	SHIP WT.	LEAD TIME*
						3MM EDGE	3MM EDGE		
 Echo™ 19" Deep Chevron Training Table w/ Echo™ base & locking casters	3ECH04.1960.PL		19"	60"	29"	\$984	\$1078	80	S
	3ECH04.1966.PL		19"	66"	29"	\$1014	\$1120	83	S
	3ECH04.1972.PL		19"	72"	29"	\$1036	\$1146	87	S
	3ECH04.1984.PL		19"	84"	29"	\$1152	\$1282	100	S
 Echo™ 19" Deep Chevron Training Table w/ Echo™ base, glides (1 side) & locking casters (1 side)	3ECH05.1960.PL		19"	60"	29"	\$972	\$1064	80	S
	3ECH05.1966.PL		19"	66"	29"	\$1002	\$1098	83	S
	3ECH05.1972.PL		19"	72"	29"	\$1022	\$1132	87	S
	3ECH05.1984.PL		19"	84"	29"	\$1138	\$1268	100	S
 Echo™ 19" Deep Chevron Training Table w/ Echo™ base & glides	3ECH06.1960.PL		19"	60"	29"	\$960	\$1052	80	S
	3ECH06.1966.PL		19"	66"	29"	\$992	\$1088	83	S
	3ECH06.1972.PL		19"	72"	29"	\$1010	\$1120	87	S
	3ECH06.1984.PL		19"	84"	29"	\$1126	\$1256	100	S

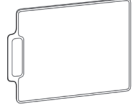
DESCRIPTION	ITEM #	NOTE	D	W	H	PRICE	SHIP WT.	LEAD TIME*
 Personal Marker Board (item sold separately)	MB2318H	Marker board trim offered in Gray (8M) Magnets may be used with marker boards	1"	23"	18"	\$224	6	S

to order

1. Item Number
2. Laminate
3. Edge Finish

example

3ECH04.1960.PL - GL - FG
ITEM NUMBER Laminate Edge

please separate each item with a dot

top options (list as separate lines on your order)

MODEL	DESCRIPTION	PRICE
3BOMC	Magnetic Clips (not to be used with side hooks)	\$82
3BOTDH2	Side Hooks (2) and Side Docks (2) (Offered in (PL) Platinum)	\$104
3BOTDH	Side Hooks (2), Center Dock (1) and Side Docks(2) (Offered in (PL) Platinum * for use on 60"w and up)	\$104
3BODH	Back pack hooks (2)	\$82
BTMP22	22" Modesty panel (to be used on a 34"w or 39"w table)	\$104
BTMP32	32" Modesty Panel (to be used on a 48"w table)	\$122
BTMP43	43" Modesty Panel (to be used on a 60"w or 66"w table)	\$140
BTMP55	55" Modesty Panel (to be used on a 72"w or 84"w table)	\$164

pin height adjustable leg options

DESCRIPTION	PRICE
ADA Compliant 24" to 35" (Add "A" in front of item #)	\$230
Standing Height 28" to 41" (Add "SH" in front of item #)	\$230

paint finish options

MODEL	DESCRIPTION	LEAD TIME
PL	Platinum	Standard 4-6 weeks

[Return to Table of Contents](#)

* S – Standard Lead Time 4-6 weeks | E – Extended Lead Time 10-12 weeks | Lead times subject to change without notice

Echo™ Series

24" deep chevron training & teaming tables

DESCRIPTION	ITEM #	NOTES	D	W	H	Standard Laminate	F9 (WRITEABLE)	SHIP WT.	LEAD TIME*
						3MM EDGE	3MM EDGE		
 Echo™ 24" Deep Chevron Training Table w/ Echo™ base & locking casters	3ECH04.2460.PL		24"	60"	29"	\$1004	\$1108	90	S
	3ECH04.2466.PL		24"	66"	29"	\$1036	\$1144	96	S
	3ECH04.2472.PL		24"	72"	29"	\$1088	\$1210	100	S
	3ECH04.2484.PL		24"	84"	29"	\$1174	\$1334	114	S

 Echo™ 24" Deep Chevron Training Table w/ Echo™ base, glides (1 side) & locking casters (1 side)	3ECH05.2460.PL		24"	60"	29"	\$992	\$1084	90	S
	3ECH05.2466.PL		24"	66"	29"	\$1022	\$1120	96	S
	3ECH05.2472.PL		24"	72"	29"	\$1074	\$1184	100	S
	3ECH05.2484.PL		24"	84"	29"	\$1160	\$1310	114	S

 Echo™ 24" Deep Chevron Training Table w/ Echo™ base & glides	3ECH06.2460.PL		24"	60"	29"	\$980	\$1096	90	S
	3ECH06.2466.PL		24"	66"	29"	\$1012	\$1130	96	S
	3ECH06.2472.PL		24"	72"	29"	\$1062	\$1196	100	S
	3ECH06.2484.PL		24"	84"	29"	\$1150	\$1320	114	S

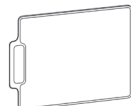
DESCRIPTION	ITEM #	NOTES	D	W	H	PRICE	SHIP WT.	LEAD TIME*
Personal Marker Board (item sold separately) 	MB2318H	Marker board trim offered in Gray (8M) Magnets may be used with marker boards	1"	23"	18"	\$224	6	S

to order

- Item Number
- Laminate
- Edge Finish

example 3ECH04.2460.PL - GL - FG

ITEM NUMBER Laminate Edge

please separate each item with a dot

top options (list as separate lines on your order)

MODEL	DESCRIPTION	PRICE
3BOMC	Magnetic Clips (not to be used with side hooks)	\$82
3BOTDH2	Side Hooks (2) and Side Docks (2) (Offered in (PL) Platinum)	\$104
3BOTDH	Side Hooks (2), Center Dock (1) and Side Docks(2) (Offered in (PL) Platinum * for use on 60"w and up)	\$104
3BODH	Back pack hooks (2)	\$82
BTMP22	22" Modesty panel (to be used on a 34"w or 39"w table)	\$104
BTMP32	32" Modesty Panel (to be used on a 48"w table)	\$122
BTMP43	43" Modesty Panel (to be used on a 60"w or 66"w table)	\$140
BTMP55	55" Modesty Panel (to be used on a 72"w or 84"w table)	\$164
BOF1	(1) Grommet with device holder and cupholder.	\$58
BOF2	(2) Grommet with device holder and cupholder. (2 will fit on 24x60 or wider)	\$116

pin height adjustable leg options



DESCRIPTION	PRICE
ADA Compliant 24" to 35" (Add "A" in front of item #)	\$230
Standing Height 28" to 41" (Add "SH" in front of item #)	\$230

paint finish options

MODEL	DESCRIPTION	LEAD TIME
PL	Platinum	Standard 4-6 weeks

Echo™ Series

30" deep chevron training & teaming tables

DESCRIPTION	ITEM #	NOTES	D	W	H	Standard Laminate	F9 (WRITEABLE)	SHIP WT.	LEAD TIME*
						3MM EDGE	3MM EDGE		
Echo™ 30" Deep Chevron Training Table w/ Echo™ base & locking casters 	3ECH04.3060.PL		30"	60"	29"	\$1046	\$1170	102	S
	3ECH04.3066.PL		30"	66"	29"	\$1068	\$1210	109	S
	3ECH04.3072.PL		30"	72"	29"	\$1120	\$1264	115	S
	3ECH04.3084.PL		30"	84"	29"	\$1218	\$1382	131	S
Echo™ 30" Deep Chevron Training Table w/ Echo™ base, glides (1 side) & locking casters (1 side) 	3ECH05.3060.PL		30"	60"	29"	\$1032	\$1156	102	S
	3ECH05.3066.PL		30"	66"	29"	\$1054	\$1196	109	S
	3ECH05.3072.PL		30"	72"	29"	\$1106	\$1250	115	S
	3ECH05.3084.PL		30"	84"	29"	\$1204	\$1368	131	S
Echo™ 30" Deep Chevron Training Table w/ Echo™ base & glides 	3ECH06.3060.PL		30"	60"	29"	\$1022	\$1146	102	S
	3ECH06.3066.PL		30"	66"	29"	\$1044	\$1186	109	S
	3ECH06.3072.PL		30"	72"	29"	\$1096	\$1240	115	S
	3ECH06.3084.PL		30"	84"	29"	\$1194	\$1358	131	S

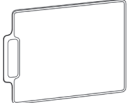
ITEM #	NOTES	D	W	H	PRICE	SHIP WT.	LEAD TIME*
Personal Marker Board (item sold separately) 	MB2318H Marker board trim offered in Gray (8M) Magnets may be used with marker boards	1"	23"	18"	\$224	6	S

to order

- Item Number
- Laminate
- Edge Finish

example

3ECH04.2460.PL - GL - FG
 ITEM NUMBER Laminate Edge
 please separate each item with a dot

top options (list as separate lines on your order)

MODEL	DESCRIPTION
3BOMC	Magnetic Clips (not to be used with side hooks)
3BOTDH2	Side Hooks (2) and Side Docks (2) (Offered in (PL) Platinum)
3BOTDH	Side Hooks (2), Center Dock (1) and Side Docks(2) (Offered in (PL) Platinum * for use on 60"w and up)
3BODH	Back pack hooks (2)
BTMP22	22" Modesty panel (to be used on a 34"w or 39"w table)
BTMP32	32" Modesty Panel (to be used on a 48"w table)
BTMP43	43" Modesty Panel (to be used on a 60"w or 66"w table)
BTMP55	55" Modesty Panel (to be used on a 72"w or 84"w table)
BOF1	(1) Grommet with device holder and cupholder.
BOF2	(2) Grommet with device holder and cupholder. (2 will fit on 30x60 or wider)

pin height adjustable leg options



DESCRIPTION	PRICE
ADA compliant 24" to 35" (Add \$104 in front of item #)	\$230
Standing Height 28" to 41" (Add \$104 in front of item #)	\$230

pair finish options

MODEL	DESCRIPTION	LEAD TIME
PL122	Platinum	Standard 4-6 weeks
	\$140	
	\$164	
	\$58	
	\$116	

Echo™ Series

24" deep meeting tables

DESCRIPTION	ITEM #	NOTES	D	W	H	Standard Laminate	F9 (WRITEABLE)	SHIP WT.	LEAD TIME*
						3MM EDGE	3MM EDGE		
Echo™ 24" Deep Meeting Table w/ Echo™ base & locking casters 	3ECH07.2460.PL		24"	60"	29"	\$1078	\$1354	90	S
	3ECH07.2472.PL		24"	72"	29"	\$1152	\$1444	100	S
	3ECH07.2484.PL		24"	84"	29"	\$1248	\$1538	114	S
Echo™ 24" Deep Meeting Table w/ Echo™ base & glides 	3ECH18.2460.PL		24"	60"	29"	\$1066	\$1342	90	S
	3ECH18.2472.PL		24"	72"	29"	\$1140	\$1432	100	S
	3ECH18.2484.PL		24"	84"	29"	\$1236	\$1526	114	S

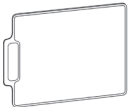
DESCRIPTION	ITEM #	NOTE	D	W	H	PRICE	SHIP WT.	LEAD TIME*
Personal Marker Board (item sold separately) 	MB2318H	Marker board trim offered in Gray (8M) Magnets may be used with marker boards	1"	23"	18"	\$224	6	S

to order

- Item Number
- Laminate
- Edge Finish

example 3ECH07.2460.PL - GL - FG

ITEM NUMBER Laminate Edge

please separate each item with a dot

top options (list as separate lines on your order)

MODEL	DESCRIPTION	PRICE
3BOTDH2	Side Hooks (2) and Side Docks (2) Offered in (PL) Platinum	ADD \$104

paint finish options

MODEL	DESCRIPTION	LEAD TIME
PL	Platinum	Standard 4-6 weeks

pin height adjustable leg options

DESCRIPTION	PRICE
ADA Compliant 24" to 35" (Add "A" in front of item #)	\$230
Standing Height 28" to 41" (Add "SH" in front of item #)	\$230

S - Standard Lead Time 4-6 weeks (Lead times subject to change without notice)

Echo™ Series

30" deep meeting tables

DESCRIPTION	ITEM #	NOTES	D	W	H	Standard Laminate	F9 (WRITEABLE)	SHIP WT.	LEAD TIME*
						3MM EDGE	3MM EDGE		
Echo™ 30" Deep Meeting Table w/ Echo™ base & locking casters	3ECH07.3060.PL		30"	60"	29"	\$1142	\$1418	102	S
	3ECH07.3072.PL		30"	72"	29"	\$1232	\$1524	115	S
	3ECH07.3084.PL		30"	84"	29"	\$1344	\$1634	131	S



Echo™ 30" Deep Meeting Table w/ Echo™ base & glides	3ECH18.3060.PL		30"	60"	29"	\$1130	\$1406	102	S
	3ECH18.3072.PL		30"	72"	29"	\$1220	\$1512	115	S
	3ECH18.3084.PL		30"	84"	29"	\$1332	\$1622	131	S



DESCRIPTION	ITEM #	NOTE	D	W	H	PRICE	SHIP WT.	LEAD TIME*
Personal Marker Board (item sold separately)	MB2318H	Marker board trim offered in Gray (8M) Magnets may used with marker boards	1"	23"	18"	\$224	6	S

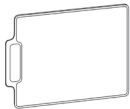

to order

1. Item Number
2. Laminate
3. Edge Finish

example

3ECH07.2460.PL - GL - FG

ITEM NUMBER Laminate Edge

please separate each item with a dot

top options (list as separate lines on your order)

MODEL	DESCRIPTION	PRICE
3BOTDH2	Side Hooks (2) and Side Docks (2) (Offered in (PL) Platinum)	ADD \$104

pin height adjustable leg options

DESCRIPTION	PRICE
ADA Compliant 24" to 35" (Add "A" in front of item #)	\$230
Standing Height 28" to 41" (Add "SH" in front of item #)	\$230

paint finish options

MODEL	DESCRIPTION	LEAD TIME
PL	Platinum	Standard 4-6 weeks

Echo™ Series

easel & marker boards

DESCRIPTION	ITEM #	NOTE	D	W	H	PRICE	SHIP WT.	LEAD TIME*
Echo™ 2-sided easel with center storage on casters. Holds 16 boards on the outside (8 per side) and stores an additional 24 on the inside. Tray for markers on top. Marker boards quoted and sold specialty.	ECEASEL.PL	Unit holds 16 marker boards (8 per side) Unit holds an additional 24 boards on the inside	26.5"	40"	61"	\$1840	200	S



DESCRIPTION	ITEM #	NOTE	D	W	H	PRICE	SHIP WT.	LEAD TIME*
Personal Marker Board (item sold separately)	MB2318H	Marker board trim offered in Gray (8M) Magnets may be used with marker boards	1"	23"	18"	\$224	6	S

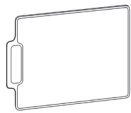

	ITEM #	NOTE	D	W	H	PRICE	SHIP WT.	LEAD TIME*
Echo™ wall mount rail for marker boards	WALLMB-42	Holds 2 marker boards – 42" w when boards are mounted		42.35"	1.9"	\$224	7	S
	WALLMB-60	Holds 3 marker boards-60" w when boards are mounted		60.5"	1.9"	\$284	8	S

	ITEM #	NOTE	D	W	H	PRICE	SHIP WT.	LEAD TIME*
	WALLMB-72	Holds 4 marker boards-72" w when boards are mounted		72.5"	1.9"	\$344	8	S

to order	1. Item Number	example	ECEASEL.PL ITEM NUMBER
----------	----------------	---------	----------------------------------



paint finish options

MODEL	DESCRIPTION	LEAD TIME
PL	Platinum	Standard 4-6 weeks

S - Standard Lead Time 4-6 weeks (Lead times subject to change without notice)

Echo™ Series

mobile educators podium desk

DESCRIPTION	ITEM #	D	W	H	3MM EDGE	SHIP WT.	LEAD TIME*
Echo™ Mobile Podium Educators Desk-24"d x 54"w x 29"h non-handed desk, Echo™ base, magnetic clip and 24"d x 17"w x 42"h podium. Platinum finish.	PEDES2454C-M.PL	24"	71"	29"/42"	\$2996	300	S
							
Echo™ Mobile Podium Educators Desk-24"d x 60"w x 29"h non-handed desk, Echo™ base, magnetic clip and 24"d x 17"w x 42"h podium. Platinum finish.	PEDES2460C-M.PL	24"	77"	29"/42"	\$3010	325	S
							
Mobile Educators Podium with casters	LCT03	24"	17"	42"	\$1998	92	E
							

to order

1. Item Number
2. Laminate
3. Edge Finish

example

PEDES2454C-M.PL - GL - FG
 ITEM NUMBER Laminate Edge
 please separate each item with a dot

top options (list as separate lines on your order)

MODEL	DESCRIPTION	PRICE
BTMP32	32" Modesty Panel (to be used on a 54"w table)	\$122
BTMP43	43" Modesty Panel (to be used on a 60"w or 66"w table)	\$140

paint finish options

MODEL	DESCRIPTION	LEAD TIME
PL	Platinum	Standard 4-6 weeks

Echo™ Series

mobile teacher's desk

DESCRIPTION	ITEM #	D	W	H	3MM EDGE	SHIP WT.	LEAD TIME*
Echo™ Mobile Teacher's Desk 24" x 54" with Box/Box/File mobile pedestal, Echo™ legs and modesty panel	ECTD.2454.PL	24"	54"	29"	\$1554	99	S



Echo™ Mobile Teacher's Desk 24" x 60" with Box/Box/File mobile pedestal, Echo™ legs and modesty panel	ECTD.2460.PL	24"	60"	29"	\$1608	107	S
---	--------------	-----	-----	-----	--------	-----	---



to order	1. Item Number	ECTD.2454.PL	-	GL	-	FG
	2. Laminate	ITEM NUMBER		Laminate		Edge
	3. Edge Finish	<i>please separate each item with a dot</i>				

paint finish options

MODEL	DESCRIPTION	LEAD TIME
PL	Platinum	Standard 4-6 weeks

Ethos Series

introduction



General

Flexible seating solutions complete the Haskell lineup of education products for a clean, consistent look; meet the demands of K–12, higher education and corporate training facilities. Designed for 21st Century Learning, Haskell seating supports dynamic classrooms where the physical environment responds to the curriculum; smoothly transitioning from lectures to collaborative activities and back, becoming a platform for active learning.

More than a chair, Ethos doubles as an active learning platform for twenty-first century pedagogy. An agile storage base plus classic seat shell, Ethos blends flexibility (like 360-degree swiveling capability and an ambidextrous worksurface) with mobility and personal storage. Haskell's seating design anticipates the needs of today's vibrant classroom, a classroom that transitions seamlessly from **lectures** to **group work** and **discussion** groups.

Lecture

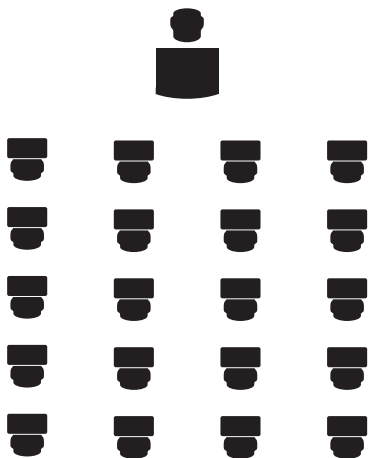

Group Work

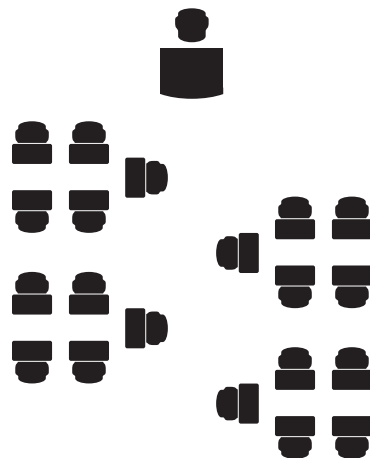

Discussion

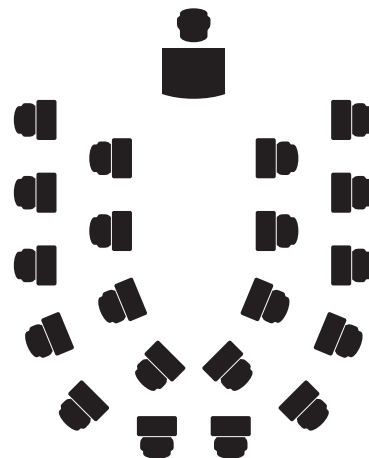

Ethos Series

product specifications

Statement of Line

Chairs and stools are available with molded polypropylene fiberglass reinforced shells. Chairs are available with a storage base, storage base with worksurface, five-star base with pneumatic adjustment. Stools are available with five-star base only.

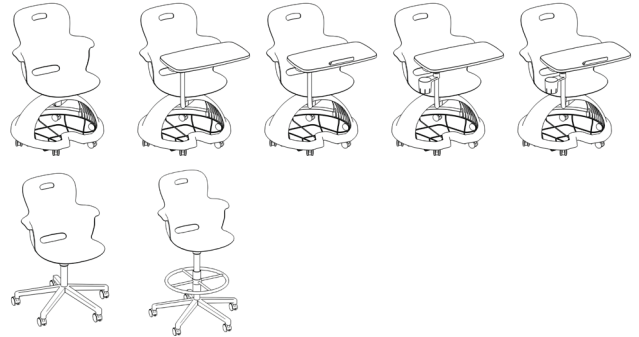

Base

The Storage base offers generous access and fully utilizes the space under the seat. The space easily accommodates large backpacks and other personal belongings and is comfortable as a footrest. The storage base comes standard with a two-toned finish. The five-star base is an option when storage is not needed.

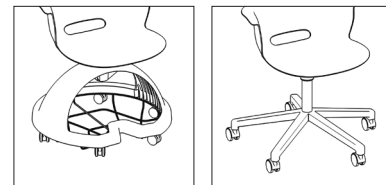

Worksurface

Worksurface is non handed and can swivel completely right and left to accommodate both right and left handed users. It is 12.5"D x 23.25"W to allow for space for both books and technology.

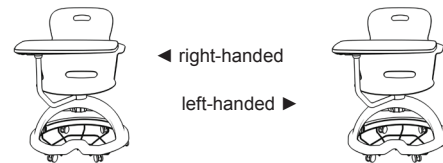

360° Swivel

360° fixed height swivel mechanism on quad base models allows students to adjust their orientation to focus on the instructor, presentation materials, and other students as needed. 360° adjustable height swivel mechanism is standard on five-star base models.

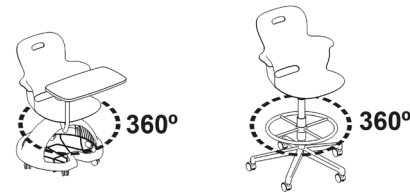

Pneumatic Five-Star Base

Seat height adjusts pneumatically. To lower, pull lever up while seated. To raise, pull lever up and keep your weight off the chair. Range of adjustability is 5" from 16"H to 21"H, a 3 3/4" range (17 1/4"H to 21"H) is available on chairs with a worksurface. Stools are standard with a 7" range of adjustability (23 1/2"H to 30 1/2"H).

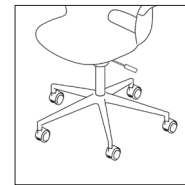

Cup Holder

Cup holder is available as an option on Ethos chairs with tablet worksurfaces.

Shipping & Assembly

The Ethos Series, including the quad, metal and five- star bases, with or without worksurface, ships standard unassembled with the seat shell separated from the base. Assembly by a qualified Haskell dealer and/or installer is recommended. No tools required for assembly.

Testing

Ethos meets or exceeds ANSI/BIFMA testing standards.

Measurements

C Shell

OUTSIDE ARM	INSIDE ARM	SEAT WIDTH	DEPTH FRONT TO BACK
23 1/2"	19 1/2"	18 1/4"	16 3/4"

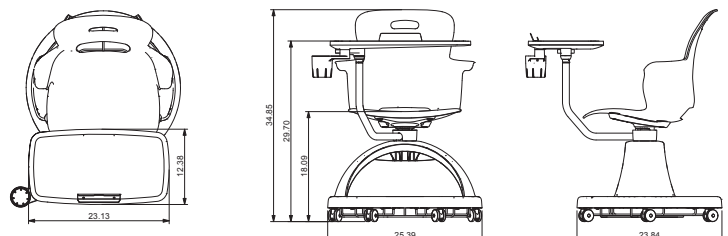

Ethos Series

18" storage base

DESCRIPTION	ITEM #	NOTES	D	W	H	PRICE	SHIP WT.	LEAD TIME*
Storage base, easy grip handle in shell. Specify casters.	2ES1C0	hard wheel casters for carpeted surfaces	24 1/2"	22 7/8"	34 1/2"	\$548	27	S
	2ES1CSW0	soft wheel casters for hard surfaces	24 1/2"	22 7/8"	34 1/2"	\$590	27	S
Storage base, articulating/telescoping work surface with pencil rim, easy grip handle in shell. Specify casters.	2ES1C1	hard wheel casters for carpeted surfaces	31 7/8"	23 1/4"	34 1/2"	\$808	36.5	S
	2ES1CSW1	soft wheel casters for hard surfaces work surface support arm in platinum (PL)	31 7/8"	23 1/4"	34 1/2"	\$850	36.5	S
Storage base, articulating/telescoping work surface with pencil rim, cup holder, easy grip handle in shell. Specify casters.	2ES1C2	hard wheel casters for carpeted surfaces	31 7/8"	23 1/4"	34 1/2"	\$850	36.5	S
	2ES1CSW2	soft wheel casters for hard surfaces work surface support arm in platinum (PL)	31 7/8"	23 1/4"	34 1/2"	\$892	36.5	S
Storage base, articulating/telescoping work surface with pencil rim and right handed tablet holder, easy grip handle in shell. Specify casters.	2ES1C3	hard wheel casters for carpeted surfaces	31 7/8"	23 1/4"	34 1/2"	\$838	36.5	S
	2ES1CSW3	soft wheel casters for hard surfaces work surface support arm in platinum (PL)	31 7/8"	23 1/4"	34 1/2"	\$880	36.5	S
Storage base, articulating/telescoping work surface with pencil rim and right handed tablet holder, cup holder, easy grip handle in shell. Specify casters.	2ES1C4	hard wheel casters for carpeted surfaces	31 7/8"	23 1/4"	34 1/2"	\$886	36.5	S
	2ES1CSW4	soft wheel casters for hard surfaces work surface support arm in platinum (PL)	31 7/8"	23 1/4"	34 1/2"	\$928	36.5	S

to order

1. Item Number (replace xx with caster option where applicable)
2. Shell Finish
3. Base Finish
4. Tablet Finish (where applicable)

example

2ES1C1 - 8A - 8L - 8M

ITEM NUMBER	SHELL FINISH	BASE FINISH	TABLET FINISH
			Only option

please separate each item with a dash

shell finish options

CODE	DESCRIPTION
8A	Black
8B	Red
8D	Sky
8E	Green Apple
8F	Orange
8I	Purple
8J	Navy
8L	Storm

base finish options





CODE	DESCRIPTION
8L	Storm Base / Platinum Metal Storage Basket
8A	Black Base / Platinum Metal Storage Basket

work surface finish

CODE	DESCRIPTION
8M	Gray (Only option)

Ethos Series

18" storage base with glides

DESCRIPTION	ITEM #	NOTES	D	W	H	PRICE	SHIP WT.	LEAD TIME*
Storage base, easy grip handle in shell, glides 	2ES1G0		24 1/2"	22 7/8"	34 1/2"	\$582	27	S
Storage base, articulating/telescoping work surface with pencil rim, easy grip handle in shell, glides 	2ES1G1	work surface support arm in platinum (PL)	31 7/8"	23 1/4"	34 1/2"	\$838	36.5	S
Storage base, articulating/telescoping work surface with pencil rim, cup holder, easy grip handle in shell, glides. 	2ES1G2	work surface support arm in platinum (PL)	31 7/8"	23 1/4"	34 1/2"	\$876	36.5	S
Storage base, articulating/telescoping work surface with pencil rim and tablet holder, easy grip handle in shell, glides 	2ES1G3	work surface support arm in platinum (PL)	31 7/8"	23 1/4"	34 1/2"	\$886	36.5	S
Storage base, articulating/telescoping work surface with pencil rim and tablet holder, cup holder, easy grip handle in shell, glides. 	2ES1G4	work surface support arm in platinum (PL)	31 7/8"	23 1/4"	34 1/2"	\$908	36.5	S

to order

1. Item Number (replace xx with caster option where applicable)
2. Shell Finish
3. Base Finish
4. Tablet Finish (where applicable)

example 2ES1C0HW - 8A - SP - 8M

ITEM NUMBER	SHELL FINISH	BASE FINISH	TABLET FINISH
2ES1C0HW	8A	SP	8M

please separate each item with a dash

shell finish options

CODE	DESCRIPTION	LEAD TIME
8A	Black	Standard 4-6 weeks
8B	Red	Standard 4-6 weeks
8D	Sky	Standard 4-6 weeks
8E	Green Apple	Standard 4-6 weeks
8F	Orange	Standard 4-6 weeks
8I	Purple	Standard 4-6 weeks
8J	Navy	Standard 4-6 weeks
8L	Storm	Standard 4-6 weeks

base finish options

CODE	DESCRIPTION
8L	Storm Base / Platinum Metal Storage Basket
8A	Black Base / Patinum Metal Storage Basket

work surface finish

CODE	DESCRIPTION
8M	Gray (Only option)

* S - Standard Lead Time 4-6 weeks (Lead times subject to change without notice)

Ethos Series

five star base

DESCRIPTION	ITEM #	NOTES	D	W	H	PRICE	SHIP WT.	LEAD TIME*
Five star base, easy grip handle in shell. Specify casters.	2ES2C0	hard wheel casters for carpeted surfaces	23 3/4"	23 3/4"	32 1/2" - 37 1/2"	\$510	33	S
	2ES2CSW0	soft wheel casters for hard surfaces pneumatic range 16" - 21"	23 3/4"	23 3/4"	32 1/2" - 37 1/2"	\$552	33	S
Five star base, easy grip handle in shell, glides	2ES2G0	pneumatic range 16" - 21"	23 3/4"	23 3/4"	32 1/2" - 37 1/2"	\$538	33	S



to order

1. Item Number (replace xx with caster option where applicable)
2. Shell Finish
3. Base Finish

example

2ES2C0HW - 8E - 8A

ITEM NUMBER SHELL FINISH BASE FINISH
Only Option

please separate each item with a dash

shell finish options

CODE	DESCRIPTION	LEAD TIME
8A	Black	Standard 4-6 weeks
8B	Red	Standard 4-6 weeks
8D	Sky	Standard 4-6 weeks
8E	Green Apple	Standard 4-6 weeks
8F	Orange	Standard 4-6 weeks
8I	Purple	Standard 4-6 weeks
8J	Navy	Standard 4-6 weeks
8L	Storm	Standard 4-6 weeks

base finish

CODE	DESCRIPTION	LEAD TIME
8A	Black Only Option	Standard 4-6 weeks

Ethos Series

stool height

DESCRIPTION	ITEM #	NOTES	D	W	H	PRICE	SHIP WT.	LEAD TIME*
Five star base, stool height, easy grip handle in shell. Specify casters	2ES4C0	hard wheel casters for carpeted surfaces	22 ¼"	23 ¾"	40" - 47"	\$724	38	S
	2ES4CSW0	soft wheel casters for hard surfaces	22 ¼"	23 ¾"	40" - 47"	\$766		
Five star base, stool height, easy grip handle in shell, glides	2ES4G0	pneumatic range 23.5" - 30.5" footring offered in black (BA)	22 ¼"	23 ¾"	40" - 47"	\$750	38	S

to order

1. Item Number (replace xx with caster option where applicable)
2. Shell Finish
3. Base Finish

example 2ES4C0HW - 8A - 8A

ITEM NUMBER SHELL FINISH BASE FINISH
Only Option

please separate each item with a dash

shell finish options

CODE	DESCRIPTION	LEAD TIME
8A	Black	Standard 4-6 weeks
8B	Red	Standard 4-6 weeks
8D	Sky	Standard 4-6 weeks
8E	Green Apple	Standard 4-6 weeks
8F	Orange	Standard 4-6 weeks
8I	Purple	Standard 4-6 weeks
8J	Navy	Standard 4-6 weeks
8L	Storm	Standard 4-6 weeks

base finish

CODE	DESCRIPTION	LEAD TIME
8A	Black Only Option	Standard 4-6 weeks

* S - Standard Lead Time 4-6 weeks (Lead times subject to change without notice)

Explorer Series®

introduction - tables



ROVER® TABLE



ROVER® TABLE



MAKER TABLE

General

The makerspace movement is becoming a powerful part of many school district curriculums. Schools are repurposing classrooms, renovating computer labs, and retooling media centers to accommodate the tools required for these creative spaces. To help foster and grow these new creative spaces, Haskell created The Rover® Table and Explorer Series®. It is a collection of innovative makerspace solutions to help schools create engaging and functional spaces while catering to the needs of these unique creative areas.

Engineered to be easily transported across the hall or across the district, the Rover® Table is the ideal solution for a shared maker curriculum.

The Explorer Maker Table by Haskell has been designed to meet the demanding needs of these creative environments.

Explorer Series®

rover® table specifications

OVERALL DIMENSIONS

Table

84x42x36.5

Mobile

84x29.5x50.5

TOP

Top Dimension: 84x42x1.5in

- Solid Birch Butcher Block

MECHANISM & LATCH

Mechanism

- Proprietary 4-bar linkage flip-top mechanism

- Gas assist

- Single user actuation

Latch

- 2 Independent lever actuated rotary

latch locks

800lb load rating (each)

BASE

Construction

- Welded Steel Tube

50mm O.D., 3mm wall

- 18 Gauge Formed and Welded Steel

Foot

- Material: Nylon

CASTERS

4 - 4" Locking Directional Total Lock

- High Strength Steel

- TPU Tread, Non-Marking

- Corrosion Resistant

- 300lb load rating (per caster)

POWER (OPTIONAL)

In Surface Power Unit

- Manufacturer : Byrne

- 3 110v Power, 2 USB

- Integrated Circuit Breaker

Rating

- 13 amps, 125 volts

Cord (Provided)

- NEMA 5-15, 14 AWG, 3 Conductor,

- 15 Amp, 10 foot

SPECIFICATIONS

Max Load

- TBD

Paint

-Textured Powder coat

MODULE OPTIONS*

Module Configuration

- 2 Bin storage modules

*Refer to module specifications for more information

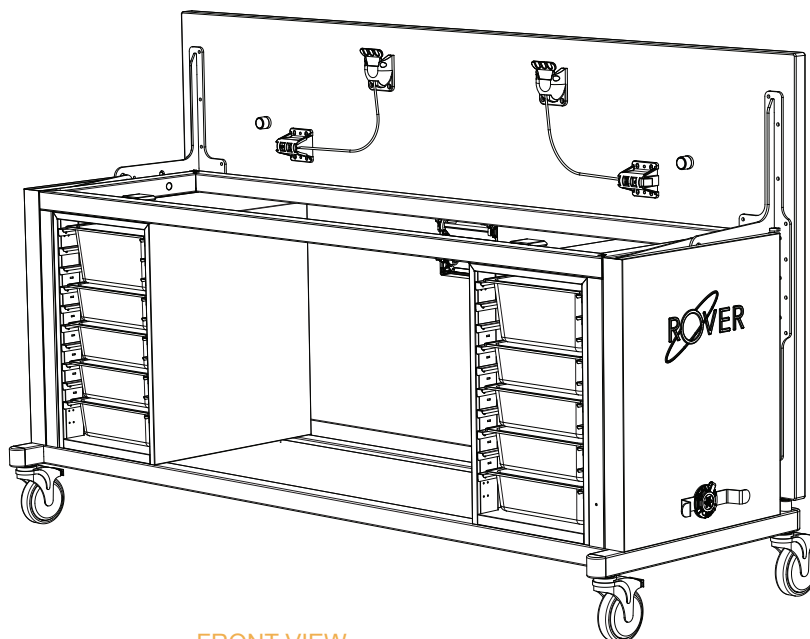

FRONT VIEW

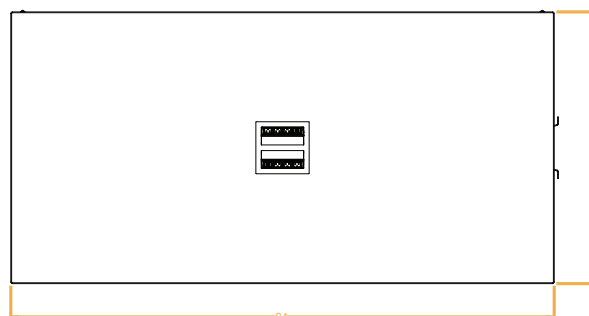

TOP VIEW

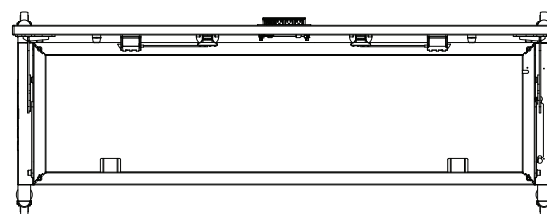

SIDE VIEWS

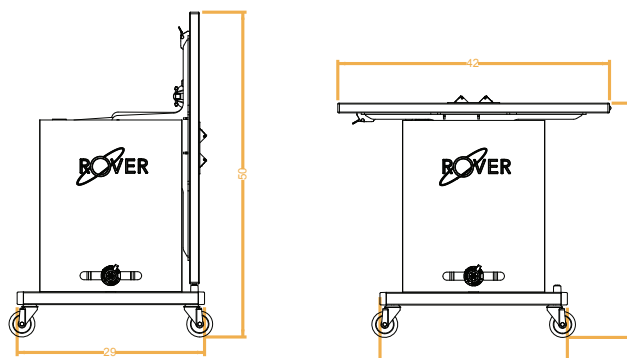

Explorer Series®

rover® table configuration

Rover® Table Module Configuration

The Rover® Table can be configured to fit the needs of your classroom or makerspace. Seven different modules are available and include open and secured storage modules, peg boards for hanging supplies like 3d printing fillament, and double-wide storage modules for larger projects. You can create your own custom configuration using the information below when ordering.

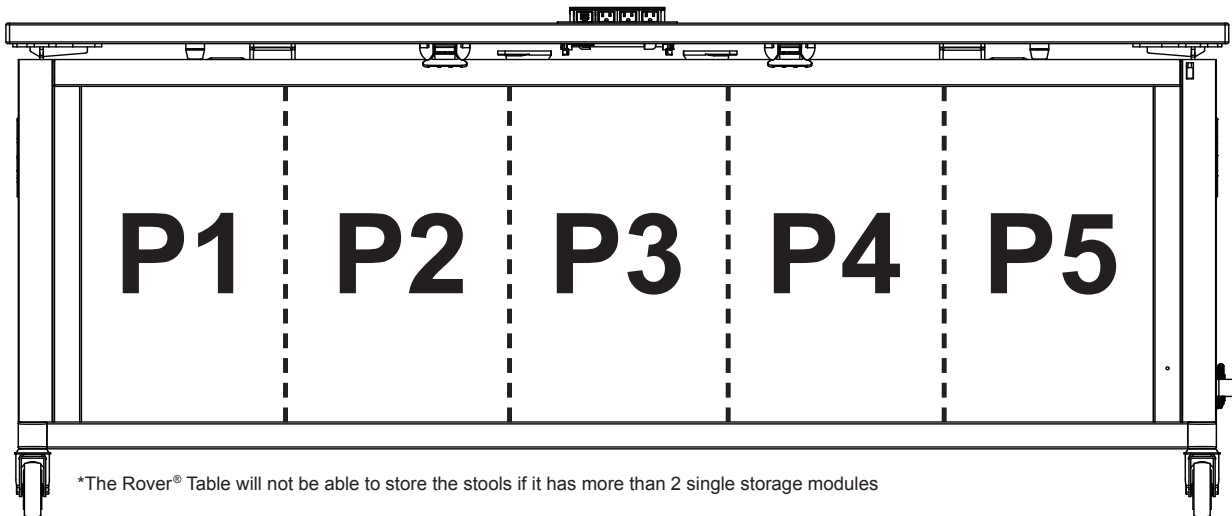

One Position Storage Modules

These storage modules use open position in the Maker Table

Bin Storage Module

BINSM

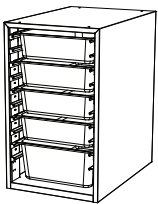

Single Storage Module*

SGLSM

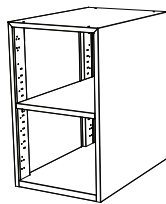

Single Storage Module with Locking Door*

SGLSMD

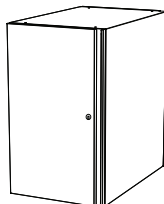

Peg Board Module

PEGSM

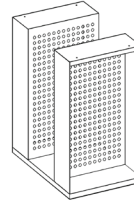

Tool Storage Module*

TOOLSM

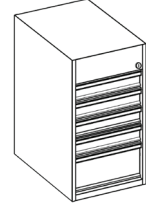

Two Position Storage Modules

These storage modules use two positions side-by-side.

Double Storage Module

DBLSM

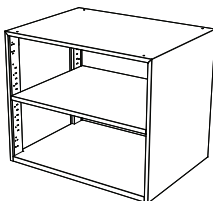

Double Storage Module with Locking Doors



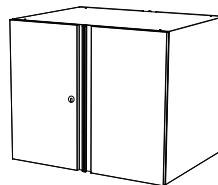

DBLSMD



Get Started with a Pre-Configured Rover® Table, or Configure Your Own!

Explorer Series®

rover® table configured

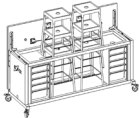
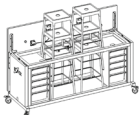
DESCRIPTION	ITEM #	D	W	H	PRICE	SHIP WT.	LEAD TIME*
Rover Table 3 Module with butcher block retractable top, 4 stools and locking casters. Platinum frame only	RV1Sxxx.4260	42"/29.5"	60"/60"	36.5"/50.5"	\$6788	368	S
							
Rover Table 3 Module with butcher block retractable top, power unit with 8ft extension cord, 4 stools and locking casters. Platinum frame only	RV1SExxx.4260	42"/29.5"	60"/60"	36.5"/50.5"	\$8142	373	S
							
Rover® Table with butcher block retractable top, bin storage modules with bins and locking casters	RV1BxxxB.4284	42"/29.5"	84"/84"	36.5"/50.5"	\$7958	386	S
							
Rover® Table with butcher block retractable top, bin storage modules with bins, power unit with 8ft extension cord and locking casters	RV1EBxxxB.4284	42"/29.5"	84"/84"	36.5"/50.5"	\$9312	391	S
							
Rover® Table with butcher block retractable top, 2 bin storage modules with bins, 6 stools and locking casters	RV1SBxxxB.4284	42"/29.5"	84"/84"	36.5"/50.5"	\$9362	428	S
							
Rover® Table with butcher block retractable top, 2 bin storage modules with bins, 6 stools, power unit with 8ft extension cord and locking casters	RV1SEBxxxB.4284	42"/29.5"	84"/84"	36.5"/50.5"	\$10716	433	S
							

to order

1. Item Number
 2. Paint Finish
- See paint finish options for frame below

example

RV1BxxxB.4284 - GA
 ITEM NUMBER PAINT FINISH
 please separate each item with a dash

paint finish options for frame

MODEL	DESCRIPTION
GA	Green Apple
EN	Navy
P2	Platinum

to order additional bins

MODEL	DESCRIPTION	PRICE
BINPK46	Clear Tote Bin Pack - Four - 4"H x 20.875"L x 12.74"W and One - 6"H x 20.875"L x 12.74"W	\$274
BINPK4	Clear Tote Bin - 4"H x 20.875"L x 12.74"W Pack of 6	\$308
BINPK6	Clear Tote Bin - 6"H x 20.875"L x 12.74"W Pack of 6	\$412

Note: Rover® ships partially assembled: top, casters, end panels need to be assembled onsite.
 Freight Class 150 Origin zip 49548

* S – Standard Lead Time 4-6 weeks

Explorer Series®

rover® stool

DESCRIPTION	ITEM #	D	W	H	PRICE	SHIP WT.	LEAD TIME*
Rover® 4 legged, 16ga steel stackable stool. 13"x13" seat. Sold as a set of 3. Textured platinum only.	RVSTOOL-PL	16.5"	16.5"	25"	\$702	42	S



Rover 4 legged, 16ga steel stackable stool. 13"x13" seat. Priced each. Textured platinum only	RVSTOOL1-P2	16.5"	16.5"	25"	\$234	14	S
---	-------------	-------	-------	-----	-------	----	---



to order

1. Select Item Number

example

RVSTOOL - P2

ITEM NUMBER

Freight Class 150 Origin zip 49548

* S – Standard Lead Time 4-6 weeks

Explorer Series®

rover® table - build your own

DESCRIPTION	ITEM #	D	W	H	PRICE	SHIP WT.	LEAD TIME*
Rover Table 3 Module with butcher block retractable top and locking casters. Add up to 3 storage modules, sold separately. Platinum frame only	RV1xxx.4260	42"/29.5"	60"/60"	36.5"/50.5"	\$5852	312	S
Rover Table 3 Module with butcher block retractable top, power unit with 8ft extension cord and locking casters. Add up to 3 storage modules, sold separately. Platinum frame only	RV1Exxx.4260	42"/29.5"	60"/60"	36.5"/50.5"	\$7206	317	S
Rover® Table with butcher block retractable top and locking casters. Add up to 5 storage modules, sold separately.	RV1xxxxx.4284	42"/29.5"	84"/84"	36.5"/50.5"	\$6142	312	S

How to Build Your Own item number

Replace "x" with storage module item number listed below. Leave "x" for empty modules (positions are laid out left to right)

MK1 or MK1E

1. Position 1
2. Position 2
3. Position 3
4. Position 4
5. Position 5

example (bin storage module, single storage module without doors, ped board module, double storage module with locking doors)

B	S	P	D	2
P1	P2	P3	P4	P5

Configurations: Five 14.7"W Modules
Two 29.4"W Modules + One 14.7"W Module
One 29.4"W Module + Three 14.7"W Modules
29.4"W Modules use 2 positions

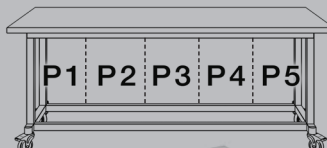

to order

1. Item Number
2. Paint Finish

See paint finish options for frame below

example

RV1BSPD2.4284 - GA







ITEM NUMBER PAINT FINISH

please separate each item with a dash

storage modules platinum finish only

MODEL	DESCRIPTION	PRICE	SHW WT
B = BINSM	Bin Storage Module- 14.7"W x 21.75"D x 24.5"H with clear tote bin pack Four - 4"H x 20.875"L x 12.74"W and One - 6"H x 20.875"L x 12.74"W	\$908	37
S = SGLSM	Single Storage Module without door- 14.7"W x 21.75"D x 24.5"H	\$554	38
D = SGLSMD	Single Storage Module w/ locking door - 14.7"W x 21.75"D x 24.5"H	\$758	49
P = PEGSM	Peg Board Module - 14.7"W x 21.75"D x 24.5"H (Doesn't include pegs or spools)	\$648	31
T = TOOLSMD	Tool Storage Module - 14.7"W x 21.75"D x 24.5"H	\$1098	
S2 = DBLSM (uses 2 positions)	Double Storage Module without doors - 29.4"W x 21.75"D x 24.5"H	\$838	50
D2 = DBLSMD (uses 2 positions)	Double Storage Module w/ locking doors - 29.4"W x 21.75"D x 24.5"H	\$1282	71

to order additional bins

MODEL	DESCRIPTION	PRICE	BINSM	DBLSM
BINPK6	Clear Tote Bin Pack - Four - 4"H x 20.875"L x 12.74"W and One - 6"H x 20.875"L x 12.74"W	\$274		
BINPK4	Clear Tote Bin - 4"H x 20.875"L x 12.74"W Pack of 6	\$308		
BINPK6	Clear Tote Bin - 6"H x 20.875"L x 12.74"W Pack of 6	\$412		

paint finish options for frame

MODEL	DESCRIPTION	SGLSMD	PEGSM
GA	Green Apple		
EN	Navy		
P2	Textured Platinum		



Note: Maker tables ship KD: Storage modules are shipped assembled except doors need to be attached onsite when applicable.

Freight Class 150 Origin zip 49548

* S – Standard Lead Time 4-6 weeks

Explorer Series®

rover® table - build your own

DESCRIPTION	ITEM #	D	W	H	PRICE	SHIP WT.	LEAD TIME*
Rover® Table with butcher block retractable top, power unit with 8ft extension cord and locking casters. Add up to 5 storage modules, sold separately.	RV1Exxxx.4284	42"/29.5"	84"/84"	36.5"/50.5"	\$7496	317	S
							
Rover Table with butcher block retractable top, 6 stools and locking casters. Add up to 5 storage modules, sold separately.	RV1Sxxxx.4284	42"/29.5"	84"/84"	36.5"/50.5"	\$7546	354	S
							
Rover Table with butcher block retractable top, 6 stools, power unit with 8ft extension cord and locking casters. Add up to 5 storage modules, sold separately.	RV1SExxxx.4284	42"/29.5"	84"/84"	36.5"/50.5"	\$8900	359	S
							

to order How to Build Your Own item number
 Replace "x" with storage module item number listed below.
 Leave "x" for empty modules (positions are laid out left to right)

MK1 or MK1E

1. Position 1
2. Position 2
3. Position 3
4. Position 4
5. Position 5

example (bin storage module, single storage module without doors, ped board module, double storage module with locking doors)

B	S	P	D	2
P1	P2	P3	P4	P5

Configurations: Five 14.7"W Modules
 Two 29.4"W Modules + One 14.7"W Module
 One 29.4"W Module + Three 14.7"W Modules
 29.4"W Modules use 2 positions

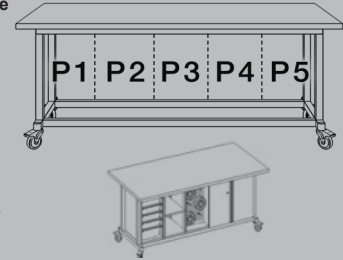







to order 1. Item Number
 2. Paint Finish
 See paint finish options for frame below

example **RV1BSPD2.4284 - GA**
 ITEM NUMBER PAINT FINISH
 please separate each item with a dash

storage modules platinum finish only

MODEL	DESCRIPTION	PRICE	SHW WT
B = BINSM	Bin Storage Module- 14.7"W x 21.75"D x 24.5"H with clear tote bin pack Four - 4"H x 20.875"L x 12.74"W and One - 6"H x 20.875"L x 12.74"W	\$908	37
S = SGLSM	Single Storage Module without door- 14.7"W x 21.75"D x 24.5"H	\$554	38
D = SGLSMD	Single Storage Module w/ locking door - 14.7"W x 21.75"D x 24.5"H	\$758	49
P = PEGSM	Peg Board Module - 14.7"W x 21.75"D x 24.5"H (Doesn't include pegs or spools)	\$648	31
T = TOOLSM	Tool Storage Module - 14.7"W x 21.75"D x 24.5"H	\$1098	
S2 = DBLSM (uses 2 positions)	Double Storage Module without doors - 29.4"W x 21.75"D x 24.5"H	\$838	50
D2 = DBLSMD (uses 2 positions)	Double Storage Module w/ locking doors - 29.4"W x 21.75"D x 24.5"H	\$1282	71

to order additional bins

MODEL	DESCRIPTION	PRICE	BINSM	DBLSM
BINPK46	Clear Tote Bin Pack - Four - 4"H x 20.875"L x 12.74"W and One - 6"H x 20.875"L x 12.74"W	\$274		
BINPK4	Clear Tote Bin - 4"H x 20.875"L x 12.74"W Pack of 6	\$308		
BINPK6	Clear Tote Bin - 6"H x 20.875"L x 12.74"W Pack of 6	\$412		

paint finish options for frame

MODEL	DESCRIPTION	SGLSMD	PEGSM
GA	Green Apple		
EN	Navy		
P2	Textured Platinum		

Note: Maker tables ship KD: Storage modules are shipped assembled except doors need to be attached onsite when applicable.

Freight Class 150 Origin zip 49548

* S - Standard Lead Time 4-6 weeks

TOOLSM



Explorer Series®

maker table configuration

Maker Table Module Configuration

The Maker Table can be configured to fit the needs of your classroom or makerspace. Six different modules are available and include open and secured storage modules, peg boards for hanging supplies like 3d printing fillament, and double-wide storage modules for larger projects. A large number of pre-configured Maker Tables are provided on the next few pages. You can also create your own custom configuration using the information below when ordering.

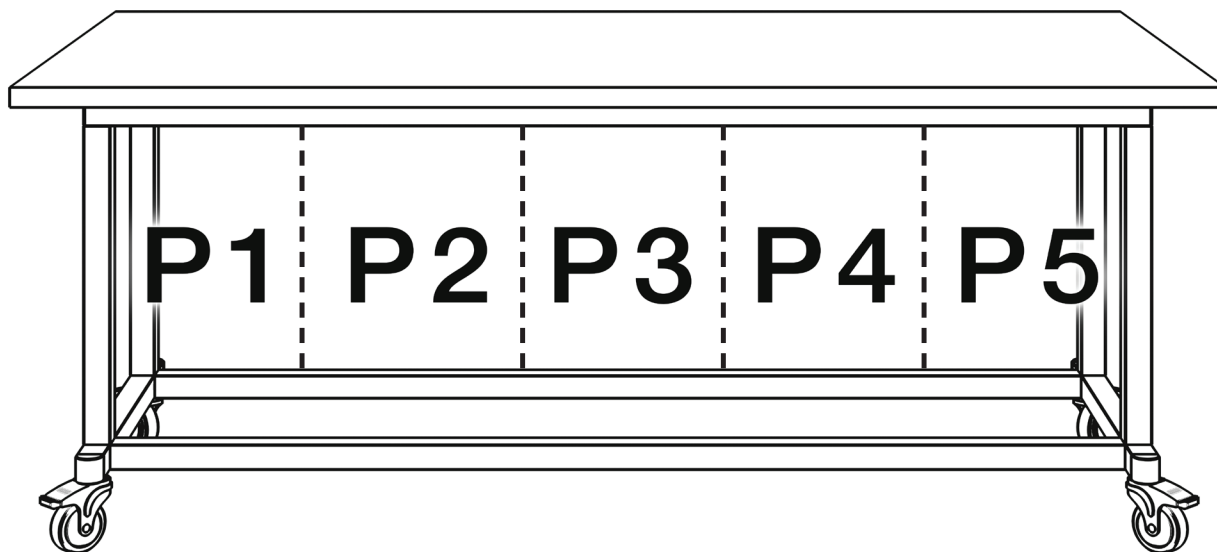

One Position Storage Modules

These storage modules use open position in the Maker Table

Bin Storage Module

BINSM

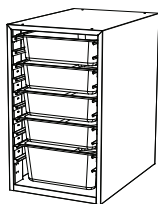

Single Storage Module*

SGLSM

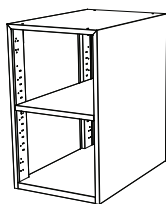

Single Storage Module with Locking Door*

SGLSMD

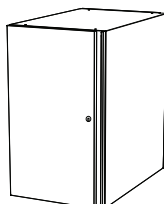

Peg Board Module

PEGSM

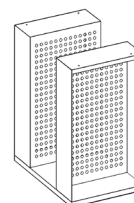

Tool Storage Module*

TOOLSMD

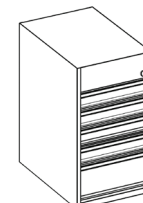

Two Position Storage Modules

These storage modules use two positions side-by-side.

Double Storage Module

DBLSM

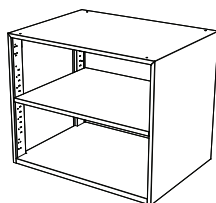

Double Storage Module with Locking Doors

DBLSMD

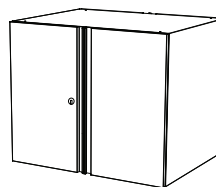

Large Format Storage Module

LGFTSM

This module can only be used with the Cargo Cart CG2 Partial Top Model to allow for full access to the Large Format Storage Module

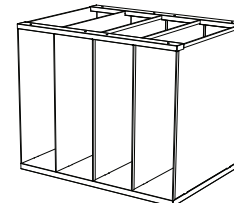

Get Started with a Pre-Configured Maker Table, or Configure Your Own!

*When specifying the single storage module or the tool storage module, you cannot specify five of these modules in a row within the frame of the Maker Table.

Explorer Series®

maker table specifications

OVERALL DIMENSIONS

84x42x36.5

TOP

Top Dimension

84x42x1.5in

- Solid Birch Butcher Block

BASE

Construction

- Welded Steel Tube

50mm O.D., 3mm wall

Foot

Material: Nylon

CASTERS

4 - 4" Locking Directional Total Lock

- High Strength Steel

- TPU Tread, Non-Marking

- Corrosion Resistant

- 300lb load rating (per caster)

POWER (OPTIONAL)

In Surface Power Unit

- Manufacturer : Byrne

- 3 110v Power, 2 USB

- Integrated Circuit Breaker Rating

13 amps, 125 volts

Cord (Provided)

- NEMA 5-15, 14 AWG, 3 Conductor,

15 Amp, 10 foot

SPECIFICATIONS

Max Load

- TBD

Paint

- Textured Powder coat

MODULE OPTIONS*

4 Module Configuration

- Double Module Configurations

Double storage

Double storage with locking doors

- Single Module Configurations

Single storage

Single storage with doors

Bin storage

Peg board

*Refer to module specifications for more information

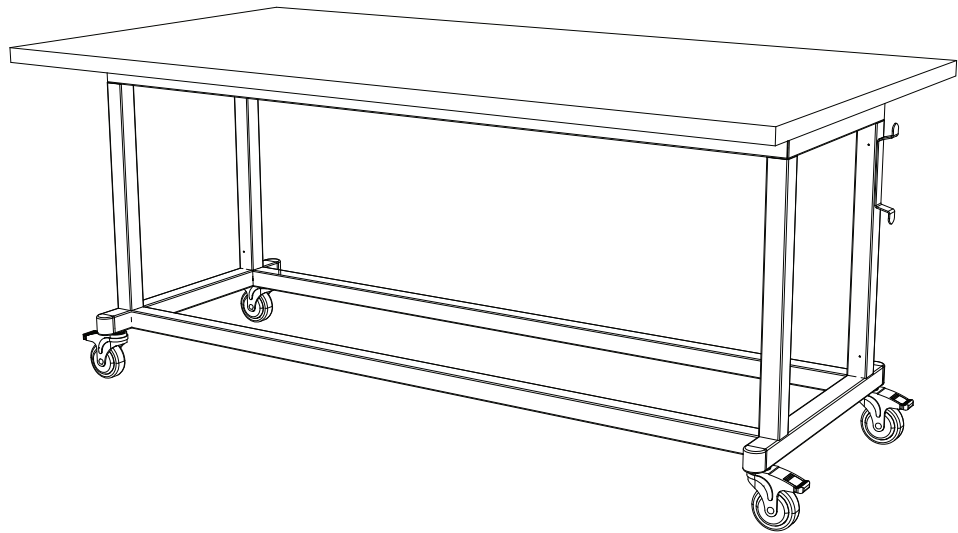

FRONT VIEW

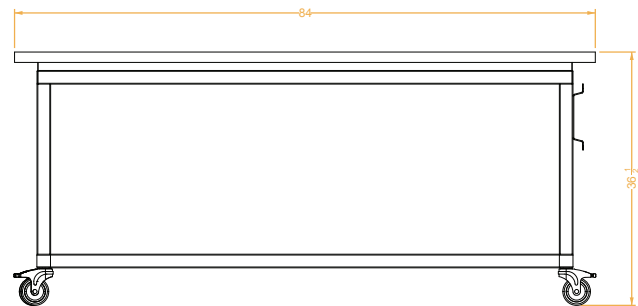

TOP VIEW





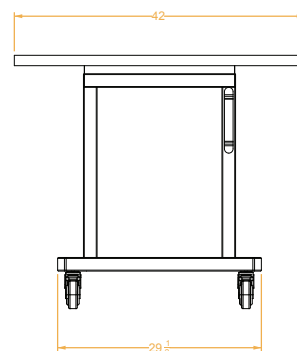

SIDE VIEW



Explorer Series®

maker table configured

DESCRIPTION	ITEM #	D	W	H	PRICE	SHIP WT.	LEAD TIME*
Maker Table 2 Module, 42d x 48w, butcher block top, 1 bin storage module, 1 single storage with doors and locking casters. Platinum frame only.	MK1BD.4248.P2	42"	48"	36.5"	\$5666	481	S
							
Maker table, 42d x 48w, butcher block top, 1 bin storage module, 1 single storage with doors, power unit with 8ft extension cord and locking casters. Platinum frame only.	MK1EBD.4248.P2	42"	48"	36.5"	\$7020	481	S
							
Maker table, 42d x 48w, butcher block top, 3 bin storage modules and locking casters. Platinum frame only.	MK1BBB.4248.P2	42"	48"	36.5"	\$6862	481	S
							
Maker table, 42d x 84w, butcher block top, 5 bin storage modules and locking casters.	MK1BBBBN.4284	42"	84"	36.5"	\$8678	481	S
							
Maker table, 42d x 84w, butcher block top, 5 bin storage modules, power unit with 8ft extension cord and locking casters.	MK1EBBBN.4284	42"	84"	36.5"	\$10032	486	S
							

to order

1. Item Number
2. Paint Finish

See paint finish options for frame below

example **MK1BBBBN.4284 - GA**

ITEM NUMBER PAINT FINISH

please separate each item with a dash

storage modules platinum finish only

MODEL	DESCRIPTION
B = BINSM	Bin Storage Module- 14.7"W x 21.75"d x 24.5"H with clear tote bin pack Four - 4"H x 20.875"L x 12.74"W and One - 6"H x 20.875"L x 12.74"W
S = SGLSM	Single Storage Module without door- 14.7"W x 21.75"d x 24.5"H
D = SGLSMD	Single Storage Module w/ locking door - 14.7"W x 21.75"d x 24.5"H
P = PEGSM	Peg Board Module - 14.7"W x 21.75"d x 24.5"H (Doesn't include pegs or spools)
T = TOOLSM	Tool Storage Module - 14.7"W x 21.75"D x 24.5"H
S2 = DBLSM (uses 2 positions)	Double Storage Module without doors - 29.4"W x 21.75"D x 24.5"H
D2 = DBLSMD (uses 2 positions)	Double Storage Module w/ locking doors - 29.4"W x 21.75"D x 24.5"H

to order additional bins

MODEL	DESCRIPTION	PRICE
BINPK46	Clear Tote Bin Pack - Four - 4"H x 20.875"L x 12.74"W and One - 6"H x 20.875"L x 12.74"W	\$274
BINPK4	Clear Tote Bin - 4"H x 20.875"L x 12.74"W Pack of 6	\$308
BINPK6	Clear Tote Bin - 6"H x 20.875"L x 12.74"W Pack of 6	\$412







Note: Maker tables ship KD: Storage modules are shipped assembled except doors need to be attached onsite when applicable.

Freight Class 150 Origin zip 49548

* S - Standard Lead Time 4-6 weeks





paint finish options for frame

MODEL	DESCRIPTION
GA	Green Apple
EN	Navy
P2	Textured Platinum

BINSM		DBLSM	
SGLSM		DBLSMD	
SGLSMD		PEGSM	
TOOLSM			

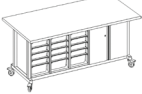
Explorer Series®

maker table configured

DESCRIPTION	ITEM #	D	W	H	PRICE	SHIP WT.	LEAD TIME*
Maker table, 42d x 84w, butcher block top, 3 bin storage modules, 1 double storage module with doors and locking casters.	MK1BBBD2.4284	42"	84"	36.5"	\$8144	478	S
							
Maker table, 42d x 84w, butcher block top, 3 bin storage modules, 1 double storage module with doors, power unit with 8ft extension cord and locking casters.	MK1EBBBD2.4284	42"	84"	36.5"	\$9498	483	S
							
Maker table, 42d x 84w, butcher block top, 3 bin storage modules, 1 double storage module without doors and locking casters.	MK1BBBS2.4284	42"	84"	36.5"	\$7700	457	S
							
Maker table, 42d x 84w, butcher block top, 3 bin storage modules, 1 double storage module without doors, power unit with 8ft extension cord and locking casters.	MK1EBBBS2.4284	42"	84"	36.5"	\$9054	462	S
							

to order
1. Item Number
2. Paint Finish
See paint finish options for frame below

example **MK1BBBBN.4284 - GA**
ITEM NUMBER PAINT FINISH
please separate each item with a dash

storage modules platinum finish only

MODEL	DESCRIPTION
B = BINSM	Bin Storage Module- 14.7"W x 21.75"d x 24.5"H with clear tote bin pack Four - 4"H x 20.875"L x 12.74"W and One - 6"H x 20.875"L x 12.74"W
S = SGLSM	Single Storage Module without door- 14.7"W x 21.75"d x 24.5"H
D = SGLSMD	Single Storage Module w/ locking door - 14.7"W x 21.75"d x 24.5"H
P = PEGSM	Peg Board Module - 14.7"W x 21.75"d x 24.5"H (Doesn't include pegs or spools)
T = TOOLSM	Tool Storage Module - 14.7"W x 21.75"D x 24.5"H
S2 = DBLSM (uses 2 positions)	Double Storage Module without doors - 29.4"W x 21.75"D x 24.5"H
D2 = DBLSMD (uses 2 positions)	Double Storage Module w/ locking doors - 29.4"W x 21.75"D x 24.5"H

paint finish options for frame

MODEL	DESCRIPTION
GA	Green Apple
EN	Navy
P2	Textured Platinum

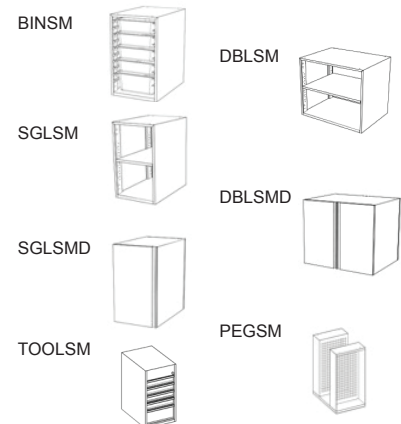

to order additional bins

MODEL	DESCRIPTION	PRICE
BINPK46	Clear Tote Bin Pack - Four - 4"H x 20.875"L x 12.74"W and One - 6"H x 20.875"L x 12.74"W	\$274
BINPK4	Clear Tote Bin - 4"H x 20.875"L x 12.74"W Pack of 6	\$308
BINPK6	Clear Tote Bin - 6"H x 20.875"L x 12.74"W Pack of 6	\$412



Note: Maker tables ship KD: Storage modules are shipped assembled except doors need to be attached onsite when applicable.

Freight Class 150 Origin zip 49548

* S - Standard Lead Time 4-6 weeks

Explorer Series®

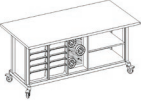
maker table configured

DESCRIPTION	ITEM #	D	W	H	PRICE	SHIP WT.	LEAD TIME*
Maker table, 42d x 84w, butcher block top, 2 bin storage modules, 1 peg board storage module, 1 double storage module without doors and locking casters.	MK1BBPS2.4284	42"	84"	36.5"	\$7440	439	S
							
Maker table, 42d x 84w, butcher block top, 2 bin storage modules, 1 peg board storage module, 1 double storage module without doors, power unit with 8ft extension cord and locking casters.	MK1EBBPS2.4284	42"	84"	36.5"	\$8794	444	S
							
Maker table, 42d x 84w, butcher block top, 1 bin storage module, 1 single storage module with door, 1 double storage module with doors, 1 bin storage module and locking casters.	MK1BDD2B.4284	42"	84"	36.5"	\$7994	491	S
							

to order

1. Item Number
2. Paint Finish

See paint finish options for frame below

example **MK1BBBBN.4284 - GA**

ITEM NUMBER PAINT FINISH

please separate each item with a dash

storage modules platinum finish only

MODEL	DESCRIPTION
B = BINSM	Bin Storage Module- 14.7"W x 21.75"d x 24.5"H with clear tote bin pack Four - 4"H x 20.875"L x 12.74"W and One - 6"H x 20.875"L x 12.74"W
S = SGLSM	Single Storage Module without door- 14.7"W x 21.75"d x 24.5"H
D = SGLSMD	Single Storage Module w/ locking door - 14.7"W x 21.75"d x 24.5"H
P = PEGSM	Peg Board Module - 14.7"W x 21.75"d x 24.5"H (Doesn't include pegs or spools)
T = TOOLSM	Tool Storage Module - 14.7"W x 21.75"D x 24.5"H
S2 = DBLSM (uses 2 positions)	Double Storage Module without doors - 29.4"W x 21.75"D x 24.5"H
D2 = DBLSMD (uses 2 positions)	Double Storage Module w/ locking doors - 29.4"W x 21.75"D x 24.5"H

to order additional bins

MODEL	DESCRIPTION	PRICE
BINPK46	Clear Tote Bin Pack - Four - 4"H x 20.875"L x 12.74"W and One - 6"H x 20.875"L x 12.74"W	\$274
BINPK4	Clear Tote Bin - 4"H x 20.875"L x 12.74"W Pack of 6	\$308
BINPK6	Clear Tote Bin - 6"H x 20.875"L x 12.74"W Pack of 6	\$412

Note: Maker tables ship KD: Storage modules are shipped assembled except doors need to be attached onsite when applicable.

Freight Class 150 Origin zip 49548

* S – Standard Lead Time 4-6 weeks

paint finish options for frame

MODEL	DESCRIPTION
GA	Green Apple
EN	Navy
P2	Textured Platinum

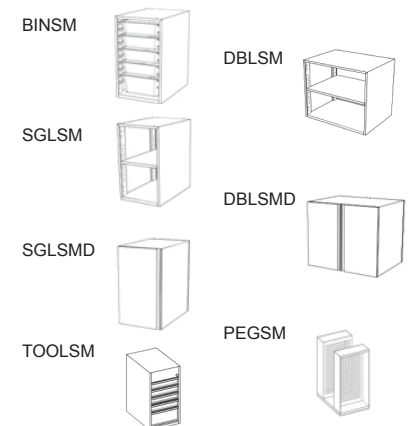

Explorer Series®

maker table configured

DESCRIPTION	ITEM #	D	W	H	PRICE	SHIP WT.	LEAD TIME*
Maker table, 42d x 84w, butcher block top, 1 bin storage module, 1 single storage module with door, 1 double storage module with doors, 1 bin storage module, power unit with 8ft extension cord and locking casters.	MK1EBDD2B.4284	42"	84"	36.5"	\$9348	496	S



Maker table, 42d x 84w, butcher block top, 1 double storage module without doors, 1 bin storage module, 1 double storage module without doors and locking casters.	MK1S2BS2.4284	42"	84"	36.5"	\$6722	409	S
--	---------------	-----	-----	-------	--------	-----	---



Maker table, 42d x 84w, butcher block top, 1 double storage module without doors, 1 bin storage module, 1 double storage module without doors, power unit with 8ft extension cord and locking casters.	MK1ES2BS2.4284	42"	84"	36.5"	\$8076	414	S
--	----------------	-----	-----	-------	--------	-----	---



to order

1. Item Number
2. Paint Finish

See paint finish options for frame below

example **MK1BBBBN.4284 - GA**

ITEM NUMBER PAINT FINISH

please separate each item with a dash

storage modules platinum finish only

MODEL	DESCRIPTION
B = BINSM	Bin Storage Module- 14.7"W x 21.75"d x 24.5"H with clear tote bin pack Four - 4"H x 20.875"L x 12.74"W and One - 6"H x 20.875"L x 12.74"W
S = SGLSM	Single Storage Module without door- 14.7"W x 21.75"d x 24.5"H
D = SGLSMD	Single Storage Module w/ locking door - 14.7"W x 21.75"d x 24.5"H
P = PEGSM	Peg Board Module - 14.7"W x 21.75"d x 24.5"H (Doesn't include pegs or spools)
T = TOOLSM	Tool Storage Module - 14.7"W x 21.75"D x 24.5"H
S2 = DBLSM (uses 2 positions)	Double Storage Module without doors - 29.4"W x 21.75"D x 24.5"H
D2 = DBLSMD (uses 2 positions)	Double Storage Module w/ locking doors - 29.4"W x 21.75"D x 24.5"H

paint finish options for frame

MODEL	DESCRIPTION
GA	Green Apple
EN	Navy
P2	Textured Platinum

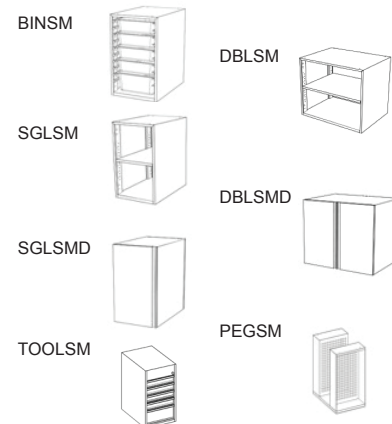

to order additional bins

MODEL	DESCRIPTION	PRICE
BINPK46	Clear Tote Bin Pack - Four - 4"H x 20.875"L x 12.74"W and One - 6"H x 20.875"L x 12.74"W	\$274
BINPK4	Clear Tote Bin - 4"H x 20.875"L x 12.74"W Pack of 6	\$308
BINPK6	Clear Tote Bin - 6"H x 20.875"L x 12.74"W Pack of 6	\$412



Note: Maker tables ship KD: Storage modules are shipped assembled except doors need to be attached onsite when applicable.

Freight Class 150 Origin zip 49548

* S - Standard Lead Time 4-6 weeks

Explorer Series®

maker table configured

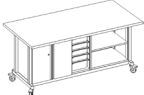
DESCRIPTION	ITEM #	D	W	H	PRICE	SHIP WT.	LEAD TIME*
Maker table, 42d x 84w, butcher block top, 1 double storage module with doors, 1 bin storage module, 1 double storage module with doors and locking casters.	MK1D2BD2.4284	42"	84"	36.5"	\$7610	475	S
							
Maker table, 42d x 84w, butcher block top, 1 double storage module with doors, 1 bin storage module, 1 double storage module with doors, power unit with 8ft extension cord and locking casters.	MK1ED2BD2.4284	42"	84"	36.5"	\$8964	480	S
							
Maker table, 42d x 84w, butcher block top, 1 double storage module with doors, 1 bin storage module, 1 double storage module without doors and locking casters.	MK1D2BS2.4284	42"	84"	36.5"	\$7166	453	S
							

to order

1. Item Number
2. Paint Finish

See paint finish options for frame below

example **MK1BBBBN.4284 - GA**

ITEM NUMBER PAINT FINISH

please separate each item with a dash

storage modules platinum finish only

MODEL	DESCRIPTION
B = BINSM	Bin Storage Module- 14.7"W x 21.75"D x 24.5"H with clear tote bin pack
	Four - 4"H x 20.875"L x 12.74"W and One - 6"H x 20.875"L x 12.74"W
S = SGLSM	Single Storage Module without door- 14.7"W x 21.75"D x 24.5"H
D = SGLSMD	Single Storage Module w/ locking door - 14.7"W x 21.75"D x 24.5"H
P = PEGSM	Peg Board Module - 14.7"W x 21.75"D x 24.5"H (Doesn't include pegs or spools)
T = TOOLSM	Tool Storage Module - 14.7"W x 21.75"D x 24.5"H
S2 = DBLSM (uses 2 positions)	Double Storage Module without doors - 29.4"W x 21.75"D x 24.5"H
D2 = DBLSMD (uses 2 positions)	Double Storage Module w/ locking doors - 29.4"W x 21.75"D x 24.5"H

to order additional bins

MODEL	DESCRIPTION	PRICE
BINPK46	Clear Tote Bin Pack - Four - 4"H x 20.875"L x 12.74"W and One - 6"H x 20.875"L x 12.74"W	\$274
BINPK4	Clear Tote Bin - 4"H x 20.875"L x 12.74"W Pack of 6	\$308
BINPK6	Clear Tote Bin - 6"H x 20.875"L x 12.74"W Pack of 6	\$412

Note: Maker tables ship KD: Storage modules are shipped assembled except doors need to be attached onsite when applicable.

Freight Class 150 Origin zip 49548

* S – Standard Lead Time 4-6 weeks

paint finish options for frame

MODEL	DESCRIPTION
GA	Green Apple
EN	Navy
P2	Textured Platinum

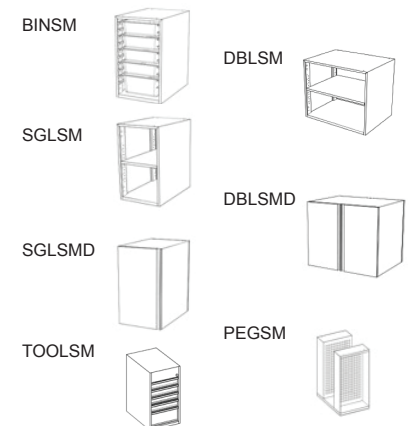

Explorer Series®

maker table configured

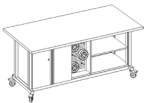
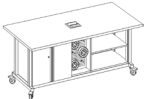
DESCRIPTION	ITEM #	D	W	H	PRICE	SHIP WT.	LEAD TIME*
Maker table, 42d x 84w, butcher block top, 1 double storage module with doors, 1 bin storage module, 1 double storage module without doors, power unit with 8ft extension cord and locking casters.	MK1ED2BS2.4284	42"	84"	36.5"	\$8520	458	S
							
Maker table, 42d x 84w, butcher block top 1 double storage module with doors, 1 peg board storage module, 1 double storage module without doors and locking casters.	MK1D2PS2.4284	42"	84"	36.5"	\$6906	454	S
							
Maker table, 42d x 84w, butcher block top, 1 double storage module with doors, 1 peg board storage module, 1 double storage module without doors, power unit with 8ft extension cord and locking casters.	MK1ED2PS2.4284	42"	84"	36.5"	\$8260	459	S
							

to order

1. Item Number
 2. Paint Finish
- See paint finish options for frame below

example

MK1BBBBN.4284 - GA

ITEM NUMBER PAINT FINISH

please separate each item with a dash

storage modules platinum finish only

MODEL	DESCRIPTION
B = BINSM	Bin Storage Module- 14.7"W x 21.75"d x 24.5"H with clear tote bin pack Four - 4"H x 20.875"L x 12.74"W and One - 6"H x 20.875"L x 12.74"W
S = SGLSM	Single Storage Module without door- 14.7"W x 21.75"d x 24.5"H
D = SGLSMD	Single Storage Module w/ locking door - 14.7"W x 21.75"d x 24.5"H
P = PEGSM	Peg Board Module - 14.7"W x 21.75"d x 24.5"H (Doesn't include pegs or spools)
T = TOOLSM	Tool Storage Module - 14.7"W x 21.75"D x 24.5"H
S2 = DBLSM (uses 2 positions)	Double Storage Module without doors - 29.4"W x 21.75"D x 24.5"H
D2 = DBLSMD (uses 2 positions)	Double Storage Module w/ locking doors - 29.4"W x 21.75"D x 24.5"H

paint finish options for frame

MODEL	DESCRIPTION
GA	Green Apple
EN	Navy
P2	Textured Platinum

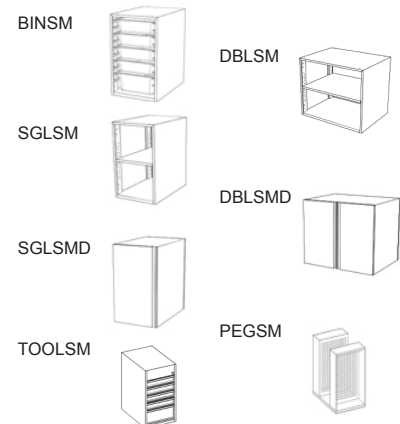

to order additional bins

MODEL	DESCRIPTION	PRICE
BINPK46	Clear Tote Bin Pack - Four - 4"H x 20.875"L x 12.74"W and One - 6"H x 20.875"L x 12.74"W	\$274
BINPK4	Clear Tote Bin - 4"H x 20.875"L x 12.74"W Pack of 6	\$308
BINPK6	Clear Tote Bin - 6"H x 20.875"L x 12.74"W Pack of 6	\$412



Note: Maker tables ship KD: Storage modules are shipped assembled except doors need to be attached onsite when applicable.

Freight Class 150 Origin zip 49548

* S - Standard Lead Time 4-6 weeks

Explorer Series®

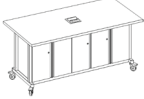
maker table configured

DESCRIPTION	ITEM #	D	W	H	PRICE	SHIP WT.	LEAD TIME*
Maker table, 42d x 84w, butcher block top, 1 double storage module with doors, 1 single storage module with doors, 1 double storage module with doors and locking casters.	MK1D2DD2.4284	42"	84"	36.5"	\$7460	487	S
							
Maker table, 42d x 84w, butcher block top, 1 double storage module with doors, 1 single storage module with doors, 1 double storage module with doors, power unit with 8ft extension cord and locking casters.	MK1ED2DD2.4284	42"	84"	36.5"	\$8814	492	S
							
Maker table, 42d x 84w, butcher block top, 1 double storage module without doors, 1 single storage module without doors, 1 double storage module without doors and locking casters.	MK1S2SS2.4284	42"	84"	36.5"	\$6368	434	S
							
Maker table, 42d x 84w, butcher block top, 1 double storage module without doors, 1 single storage module without doors, 1 double storage module without doors, power unit with 8ft extension cord and locking casters.	MK1ES2SS2.4284	42"	84"	36.5"	\$7722	439	S
							

to order
 1. Item Number
 2. Paint Finish
 See paint finish options for frame below

example
MK1BBBBN.4284 - GA
 ITEM NUMBER PAINT FINISH
 please separate each item with a dash

storage modules platinum finish only







MODEL	DESCRIPTION
B = BINSM	Bin Storage Module- 14.7"W x 21.75"d x 24.5"H with clear tote bin pack Four - 4"H x 20.875"L x 12.74"W and One - 6"H x 20.875"L x 12.74"W
S = SGLSM	Single Storage Module without door- 14.7"W x 21.75"d x 24.5"H
D = SGLSMD	Single Storage Module w/ locking door - 14.7"W x 21.75"d x 24.5"H
P = PEGSM	Peg Board Module - 14.7"W x 21.75"d x 24.5"H (Doesn't include pegs or spools)
T = TOOLSM	Tool Storage Module - 14.7"W x 21.75"D x 24.5"H
S2 = DBLSM (uses 2 positions)	Double Storage Module without doors - 29.4"W x 21.75"D x 24.5"H
D2 = DBLSMD (uses 2 positions)	Double Storage Module w/ locking doors - 29.4"W x 21.75"D x 24.5"H

to order additional bins

MODEL	DESCRIPTION	PRICE
BINPK46	Clear Tote Bin Pack - Four - 4"H x 20.875"L x 12.74"W and One - 6"H x 20.875"L x 12.74"W	\$274
BINPK4	Clear Tote Bin - 4"H x 20.875"L x 12.74"W Pack of 6	\$308
BINPK6	Clear Tote Bin - 6"H x 20.875"L x 12.74"W Pack of 6	\$412

Note: Maker tables ship KD: Storage modules are shipped assembled except doors need to be attached onsite when applicable.
 Freight Class 150 Origin zip 49548
 * S - Standard Lead Time 4-6 weeks

paint finish options for frame

MODEL	DESCRIPTION
GA	Green Apple
EN	Navy
P2	Textured Platinum
BINSM	
DBLSM	
SGLSM	
DBLSMD	
SGLSMD	
PEGSM	
TOOLSM	

Explorer Series®

maker table - build your own

DESCRIPTION	ITEM #	D	W	H	PRICE	SHIP WT.	LEAD TIME*
Maker Table 2 Module, 42d x 48w, butcher block top and locking casters. Add up to 2 storage modules, sold separately. Platinum frame only.	MK1xx.4248	42"	84"	36.5"	\$4000	296	S
Maker Table 2 Module, 42d x 48w, butcher block top, power unit with 8ft extension cord and locking casters and locking casters. Add up to 2 storage modules, sold separately. Platinum frame only	MK1Exx.4248	42"	84"	36.5"	\$5354	296	S



to order How to Build Your Own item number
 Replace "x" with storage module item number listed below.
 Leave "x" for empty modules (positions are laid out left to right)

MK1 or MK1E

1. Position 1
2. Position 2
3. Position 3
4. Position 4
5. Position 5

example (bin storage module, single storage module without doors, ped board module, double storage module with locking doors)

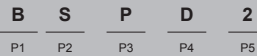

Configurations: Five 14.7"W Modules
 Two 29.4"W Modules + One 14.7"W Module
 One 29.4"W Module + Three 14.7"W Modules
 29.4"W Modules use 2 positions

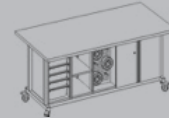
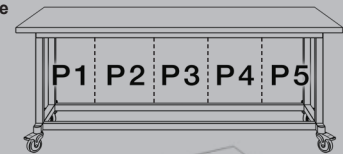

to order 1. Item Number
 2. Paint Finish
 See paint finish options for frame below



please separate each item with a dash

storage modules platinum finish only

MODEL	DESCRIPTION	PRICE	SHIP WT
B = BINSM	Bin Storage Module- 14.7"W x 21.75"D x 24.5"H with clear tote bin pack Four - 4"H x 20.875"L x 12.74"W and One - 6"H x 20.875"L x 12.74"W	\$908	37
S = SGLSM	Single Storage Module without door- 14.7"W x 21.75"D x 24.5"H	\$554	38
D = SGLSMD	Single Storage Module w/ locking door - 14.7"W x 21.75"D x 24.5"H	\$758	49
P = PEGSM	Peg Board Module - 14.7"W x 21.75"D x 24.5"H (Doesn't include pegs or spools)	\$648	31
T = TOOLSM	Tool Storage Module - 14.7"W x 21.75"D x 24.5"H	\$1098	
S2 = DBLSM (uses 2 positions)	Double Storage Module without doors - 29.4"W x 21.75"D x 24.5"H	\$838	50
D2 = DBLSMD (uses 2 positions)	Double Storage Module w/ locking doors - 29.4"W x 21.75"D x 24.5"H	\$1282	71

to order additional bins

MODEL	DESCRIPTION	PRICE
BINPK46	Clear Tote Bin Pack - Four - 4"H x 20.875"L x 12.74"W and One - 6"H x 20.875"L x 12.74"W	\$274
BINPK4	Clear Tote Bin - 4"H x 20.875"L x 12.74"W Pack of 6	\$308
BINPK6	Clear Tote Bin - 6"H x 20.875"L x 12.74"W Pack of 6	\$412

paint finish options for frame

MODEL	DESCRIPTION
GA	Green Apple
EN	Navy
P2	Textured Platinum

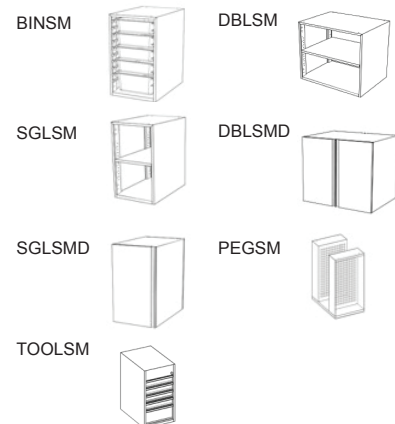

Note: Maker tables ship KD: Storage modules are shipped assembled except doors need to be attached onsite when applicable.

Freight Class 150 Origin zip 49548

* S - Standard Lead Time 4-6 weeks

Explorer Series®

maker table - build your own

DESCRIPTION	ITEM #	D	W	H	PRICE	SHIP WT.	LEAD TIME*
Maker table, 42d x 84w, butcher block top and locking casters. Add up to 5 storage modules, sold separately.	MK1xxxxx.4284	42"	84"	36.5"	\$4138	296	S



Maker table, 42d x 84w, butcher block top, power unit with 8ft extension cord and locking casters. Add up to 5 storage modules, sold separately.	MK1Exxxxx.4284	42"	84"	36.5"	\$5492	296	S
--	----------------	-----	-----	-------	--------	-----	---



to order How to Build Your Own item number

Replace "x" with storage module item number listed below.
Leave "x" for empty modules (positions are laid out left to right)

MK1 or MK1E

- Position 1
- Position 2
- Position 3
- Position 4
- Position 5

example (bin storage module, single storage module without doors, ped board module, double storage module with locking doors)

B	S	P	D	2
P1	P2	P3	P4	P5

Configurations: Five 14.7"W Modules
Two 29.4"W Modules + One 14.7"W Module
One 29.4"W Module + Three 14.7"W Modules
29.4"W Modules use 2 positions

to order

- Item Number
- Paint Finish

See paint finish options for frame below

example **MK1BSPD2.4284 - GA**

ITEM NUMBER PAINT FINISH

please separate each item with a dash

storage modules platinum finish only

MODEL	DESCRIPTION	PRICE	SHW WT
B = BINSM	Bin Storage Module- 14.7"W x 21.75"d x 24.5"H with clear tote bin pack Four - 4"H x 20.875"L x 12.74"W and One - 6"H x 20.875"L x 12.74"W	\$908	37
S = SGLSM	Single Storage Module without door- 14.7"W x 21.75"d x 24.5"H	\$554	38
D = SGLSMD	Single Storage Module w/ locking door - 14.7"W x 21.75"d x 24.5"H	\$758	49
P = PEGSM	Peg Board Module - 14.7"W x 21.75"d x 24.5"H (Doesn't include pegs or spools)	\$648	31
T = TOOLSMD	Tool Storage Module - 14.7"W x 21.75"D x 24.5"H	\$1098	
S2 = DBLSM (uses 2 positions)	Double Storage Module without doors - 29.4"W x 21.75"D x 24.5"H	\$838	50
D2 = DBLSMD (uses 2 positions)	Double Storage Module w/ locking doors - 29.4"W x 21.75"D x 24.5"H	\$1282	71

to order additional bins

MODEL	DESCRIPTION	PRICE
BINPK46	Clear Tote Bin Pack - Four - 4"H x 20.875"L x 12.74"W and One - 6"H x 20.875"L x 12.74"W	\$274
BINPK4	Clear Tote Bin - 4"H x 20.875"L x 12.74"W Pack of 6	\$308
BINPK6	Clear Tote Bin - 6"H x 20.875"L x 12.74"W Pack of 6	\$412

paint finish options for frame

MODEL	DESCRIPTION
GA	Green Apple
EN	Navy
P2	Textured Platinum

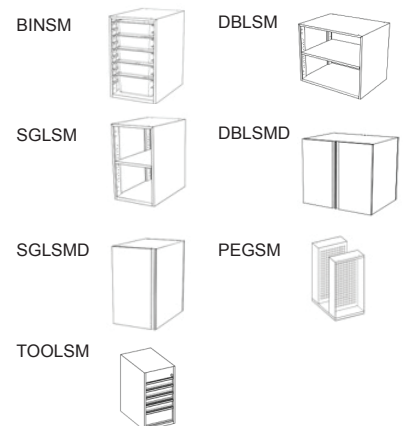

Note: Maker tables ship KD: Storage modules are shipped assembled except doors need to be attached onsite when applicable.

Freight Class 150 Origin zip 49548

* S - Standard Lead Time 4-6 weeks

Explorer Series®

introduction - carts

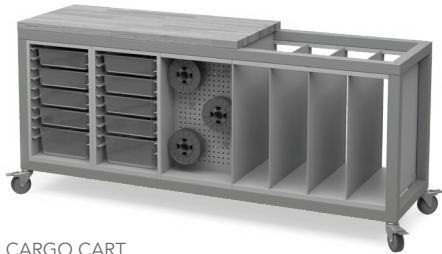

CARGO CART



CUBBY STORAGE CART



TALL STORAGE CART



PACK CART



MARKER BOARD BACK

General

The makerspace movement is becoming a powerful part of many school district curriculums. Schools are repurposing classrooms, renovating computer labs, and retooling media centers to accommodate the tools required for these creative spaces. To help foster and grow these new creative spaces, Haskell created The Rover® Table and Explorer Series®. It is a collection of innovative makerspace solutions to help schools create engaging and functional spaces while catering to the needs of these unique creative areas.

Engineered to be easily transported across the hall or across the district, the Rover® Table is the ideal solution for a shared maker curriculum.

The Explorer Series® Think Nook™ is the perfect solution for students who need quiet time to think, read or simply recharge.

The Explorer Maker Table by Haskell has been designed to meet the demanding needs of these creative environments.

The Explorer Cargo Cart by Haskell is the perfect support solution to our Rover® Table and Maker Table allowing easy access to all the many different maker manipulatives needed.

The Tall Storage Cart allows educators to organize, store and distribute learning materials or maker manipulatives.

The Cubby Storage Cart is a versatile, mobile piece that offers a sleek design solution for classroom storage and makerspaces.

The Pack Cart replaces the need for built in casework or lockers by providing mobile backpack storage while functioning as a multipurpose ideation tool.

Explorer Series®

cargo cart configuration

Cargo Cart Module Configuration

The Cargo Cart can be configured to fit the needs of your classroom or makerspace. Seven different modules are available and include open and secured storage modules, peg boards for hanging supplies like 3d printing filament, and a large format storage module which is unique to the cargo cart. A large number of pre-configured Cargo Carts are provided on the next few pages. You can also create your own custom configuration using the information below when ordering.

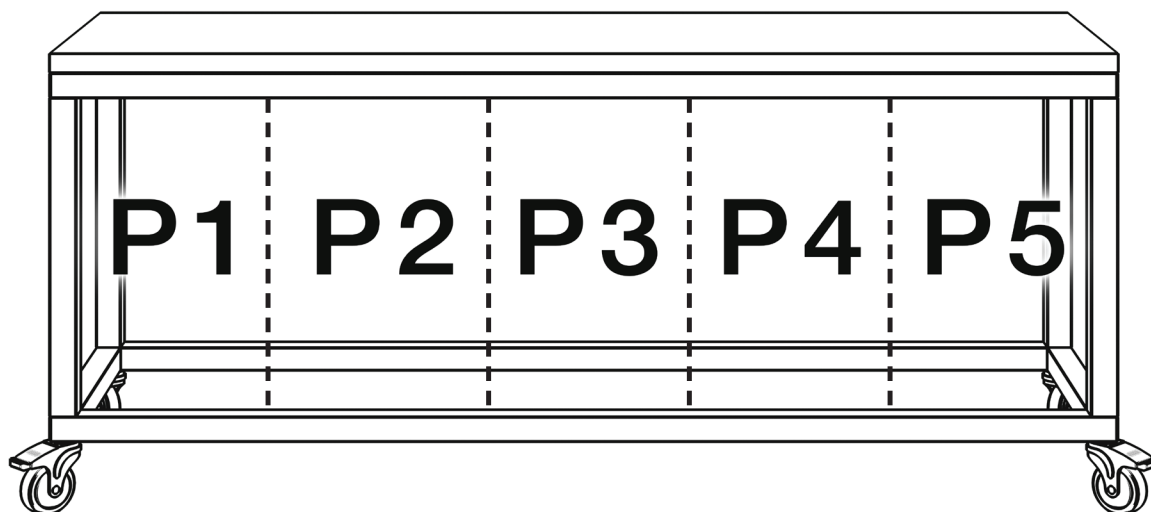

One Position Storage Modules

These storage modules use one position in the Cargo Cart.

Bin Storage Module
BINSM

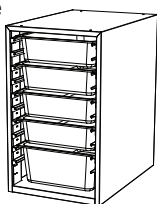

Single Storage Module*
SGLSM

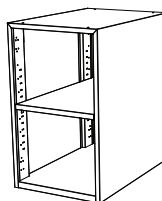

Single Storage Module with Locking Door*
SGLSMD

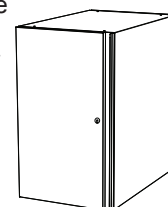

Tool Storage Module*
TOOLSMD



Peg Board Module
PEGSM

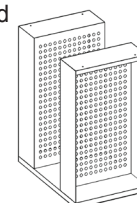

Two Position Storage Modules

These storage modules use two positions side-by-side.

Double Storage Module
DBLSM

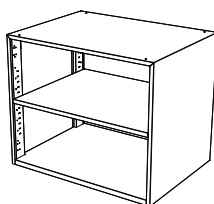

Double Storage Module with Locking Doors
DBLSMD

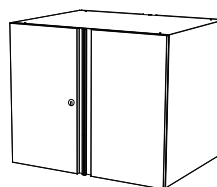

Large Format Storage Module
LGFTSM

This module can only be used with the Cargo Cart CG1 Partial Top Model to allow for full access to the Large Format Storage Module

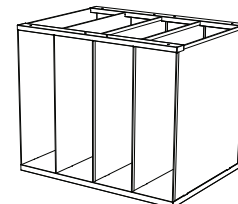

Get Started with a Pre-Configured Cargo Cart, or Configure Your Own!

*When specifying the single storage module or the tool storage module, you cannot specify five of these modules in a row within the frame of the Cargo Cart.

Explorer Series®

cargo cart specification

OVERALL DIMENSIONS

77.5x22x35.5

TOP

Top Dimension

Partial Top: 47x22x1.5

Full Top: 77.5x22x1.5

- Solid Birch Butcher Block

BASE

Construction

- Welded Steel Tube

50mm O.D., 3mm wall

- 18 Gauge Formed and Welded Steel

Foot

Material: Nylon

CASTERS

4 - 4" Locking Directional Total Lock

- High Strength Steel

- TPU Tread, Non-Marking

- Corrosion Resistant

- 300lb load rating (per caster)

SPECIFICATIONS

Max Load

- TBD

Paint

- Textured Powder coat

MODULE OPTIONS*

4 Module Configuration

- Double Module Configurations

Double storage

Double storage with locking door

Large Format Storage

- Single Module Configurations

Single storage

Single storage with doors

Bin storage

Peg board

*Refer to module specifications for more information

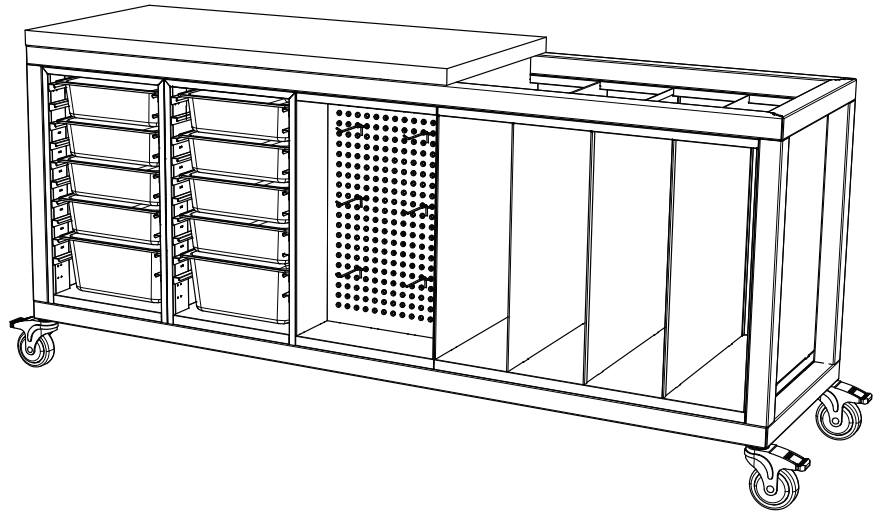

FRONT VIEW - PARTIAL TOP

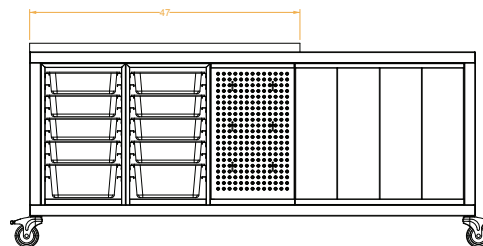

FRONT VIEW - FULL TOP

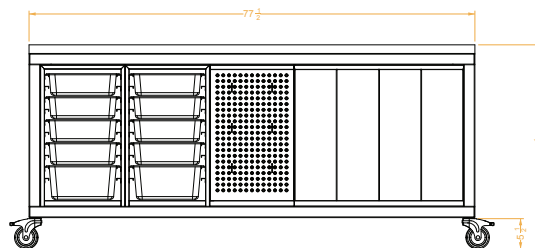

TOP VIEW - PARTIAL TOP

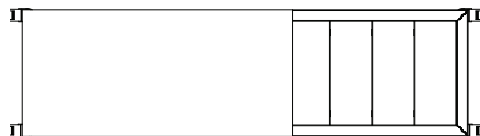

TOP VIEW - FULL TOP



SIDE VIEW

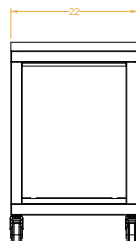

Explorer Series®

cargo cart configured

DESCRIPTION	ITEM #	D	W	H	PRICE	SHIP WT.	LEAD TIME*
Cargo Cart with 22d x 46w butcher block top, 3 bin storage modules, 1 large format storage module and locking casters.	CG1BBBL2.2246	22"	77.5"	35.5"	\$6310	373	S

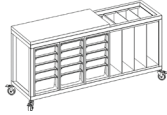

Cargo Cart with 22d x 46w butcher block top, 1 double storage module with doors, 1 single storage module with door, 1 large format storage module and locking casters.	CG1D2DL2.2246	22"	77.5"	35.5"	\$5626	382	S
--	---------------	-----	-------	-------	--------	-----	---

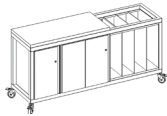

Cargo Cart with 22d x 46w butcher block top, 1 double storage module without doors, 1 peg board storage module, 1 large format module and locking casters.	CG1S2PL2.2246	22"	77.5"	35.5"	\$5072	342	*
--	---------------	-----	-------	-------	--------	-----	---

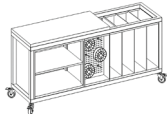

to order

1. Item Number
2. Paint Finish

See paint finish options for frame below

example CG1BBBL2.2246 - GA

ITEM NUMBER PAINT FINISH

please separate each item with a dash

storage modules platinum finish only

MODEL	DESCRIPTION
B = BINSM	Bin Storage Module- 14.7"W x 21.75"D x 24.5"H with bins Four - 4"H x 20.875"L x 12.74"W and One - 6"H x 20.875"L x 12.74"W
S = SGLSM	Single Storage Module - 14.7"W x 21.75"D x 24.5"H
D = SGLSMD	Single Storage Module w/ locking doors - 14.7"W x 21.75"D x 24.5"H
P = PEGSM	Peg Board Module - 14.7"W x 21.75"D x 24.5"H
T = TOOLSM	Tool Storage Module - 14.7"W x 21.75"D x 24.5"H
S2 = DBLSM (uses 2 positions)	Double Storage Module without doors 29.4"W x 21.75"D x 24.5"H
D2 = DBLSMD (uses 2 positions)	Double Storage Module w/ locking doors - 29.4"W x 21.75"D x 24.5"H
L2 = LGFTSM (uses 2 positions)	Large Format Storage Module - 29.4"W x 21.75"D x 24.5"H Large Format Storage Module can only be used with CG2 partial top model.

paint finish options for frame

MODEL	DESCRIPTION
GA	Green Apple
EN	Navy
P2	Textured Platinum

to order additional bins

MODEL	DESCRIPTION	PRICE
BINPK46	Clear Tote Bin Pack - Four - 4"H x 20.875"L x 12.74"W and One - 6"H x 20.875"L x 12.74"W	\$274
BINPK4	Clear Tote Bin - 4"H x 20.875"L x 12.74"W Pack of 6	\$308
BINPK6	Clear Tote Bin - 6"H x 20.875"L x 12.74"W Pack of 6	\$412

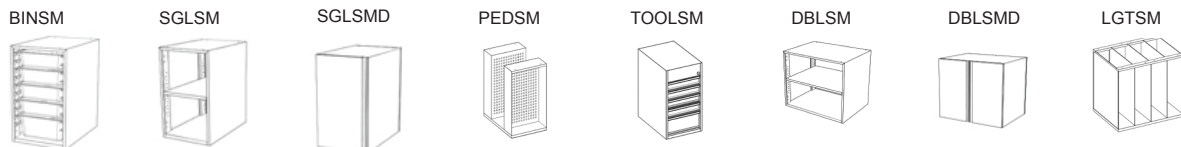

Note: Cargo carts ship KD: Storage modules are shipped assembled except doors need to be attached onsite when applicable.

Freight Class 150 Origin zip 49548

* S - Standard Lead Time 4-6 weeks

Explorer Series®

cargo cart configured

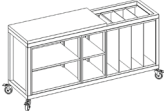
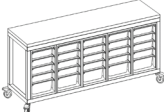
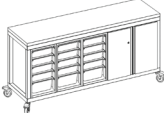
DESCRIPTION	ITEM #	D	W	H	PRICE	SHIP WT.	LEAD TIME*
Cargo Cart with 22d x 46w butcher block top, 1 double storage module without doors, 1 single storage unit without door, 1 large format storage module and locking casters.	CG1S2SL2.2246	22"	77.5"	35.5"	\$4978	350	*
							
Cargo Cart with 22d x 77w butcher block top, 5 bin storage modules and locking casters.	CG2BBBBN.2277	22"	77.5"	35.5"	\$7528	415	*
							
Cargo Cart with 22d x 77w butcher block top, 3 bin storage modules, 1 double storage module with doors and locking casters.	CG2BBBD2.2277	22"	77.5"	35.5"	\$6994	412	*
							

to order

1. Item Number
 2. Paint Finish
- See paint finish options for frame below

example

CG1BBBL2.2246 - GA

ITEM NUMBER PAINT FINISH

please separate each item with a dash

storage modules platinum finish only

MODEL	DESCRIPTION
B = BINSM	Bin Storage Module- 14.7"W x 21.75"d x 24.5"H with bins Four - 4"H x 20.875"L x 12.74"W and One - 6"H x 20.875"L x 12.74"W
S = SGLSM	Single Storage Module - 14.7"W x 21.75"d x 24.5"H
D = SGLSMD	Single Storage Module w/ locking doors - 14.7"W x 21.75"d x 24.5"H
P = PEGSM	Peg Board Module - 14.7"W x 21.75"d x 24.5"H
T = TOOLSM	Tool Storage Module - 14.7"W x 21.75"D x 24.5"H
S2 = DBLSM (uses 2 positions)	Double Storage Module without doors - 29.4"W x 21.75"D x 24.5"H
D2 = DBLSMD (uses 2 positions)	Double Storage Module w/ locking doors - 29.4"W x 21.75"D x 24.5"H
L2 = LGFTSM (uses 2 positions)	Large Format Storage Module - 29.4"W x 21.75"D x 24.5"H Large Format Storage Module can only be used with CG2 partial top model.

paint finish options for frame

MODEL	DESCRIPTION
GA	Green Apple
EN	Navy
P2	Textured Platinum

to order additional bins

MODEL	DESCRIPTION	PRICE
BINPK46	Clear Tote Bin Pack - Four - 4"H x 20.875"L x 12.74"W and One - 6"H x 20.875"L x 12.74"W	\$274
BINPK4	Clear Tote Bin - 4"H x 20.875"L x 12.74"W Pack of 6	\$308
BINPK6	Clear Tote Bin - 6"H x 20.875"L x 12.74"W Pack of 6	\$412

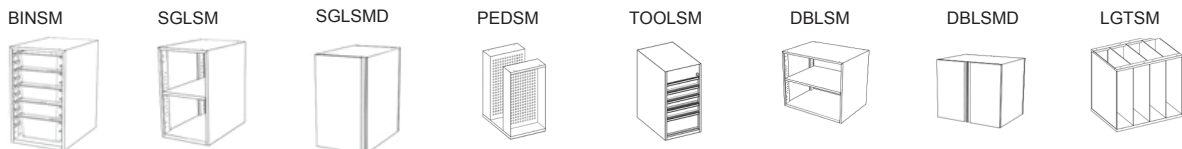

Note: Cargo carts ship KD: Storage modules are shipped assembled except doors need to be attached onsite when applicable.

Freight Class.150 Origin zip 49548

Return to Table of Contents

S = Standard Lead Time 4-6 weeks

Explorer Series®

cargo cart configured

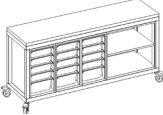
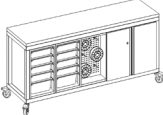
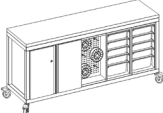
DESCRIPTION	ITEM #	D	W	H	PRICE	SHIP WT.	LEAD TIME*
Cargo Cart with 22d x 77w butcher block top, 3 bin storage modules, 1 double storage module without doors and locking casters.	CG2BBBS2.2277	22"	77.5"	35.5"	\$6550	391	*
							
Cargo Cart with 22d x 77w butcher block top, 2 bin storage modules, 1 peg board storage module, 1 double storage module with doors and locking casters.	CG2BBPD2.2277	22"	77.5"	35.5"	\$6734	406	*
							
Cargo Cart with 22d x 77w butcher block top, 1 double storage module with doors, 1 peg board storage module, 2 bin storage modules and locking casters.	CG2D2PBB.2277	22"	77.5"	35.5"	\$6734	406	*
							

to order

- Item Number
- Paint Finish

See paint finish options for frame below

example **CG2BBBL2.2246 - GA**

ITEM NUMBER PAINT FINISH

please separate each item with a dash

storage modules platinum finish only

MODEL	DESCRIPTION
B = BINSM	Bin Storage Module- 14.7"W x 21.75"D x 24.5"H with bins Four - 4"H x 20.875"L x 12.74"W and One - 6"H x 20.875"L x 12.74"W
S = SGLSM	Single Storage Module - 14.7"W x 21.75"D x 24.5"H
D = SGLSMD	Single Storage Module w/ locking doors - 14.7"W x 21.75"D x 24.5"H
P = PEGSM	Peg Board Module - 14.7"W x 21.75"D x 24.5"H
T = TOOLSMD	Tool Storage Module - 14.7"W x 21.75"D x 24.5"H
S2 = DBLSM (uses 2 positions)	Double Storage Module without doors - 29.4"W x 21.75"D x 24.5"H
D2 = DBLSMD (uses 2 positions)	Double Storage Module w/ locking doors - 29.4"W x 21.75"D x 24.5"H
L2 = LGFTSM (uses 2 positions)	Large Format Storage Module - 29.4"W x 21.75"D x 24.5"H Large Format Storage Module can only be used with CG2 partial top model.

paint finish options for frame

MODEL	DESCRIPTION
GA	Green Apple
EN	Navy
P2	Textured Platinum

to order additional bins

MODEL	DESCRIPTION	PRICE
BINPK46	Clear Tote Bin Pack - Four - 4"H x 20.875"L x 12.74"W and One - 6"H x 20.875"L x 12.74"W	\$274
BINPK4	Clear Tote Bin - 4"H x 20.875"L x 12.74"W Pack of 6	\$308
BINPK6	Clear Tote Bin - 6"H x 20.875"L x 12.74"W Pack of 6	\$412

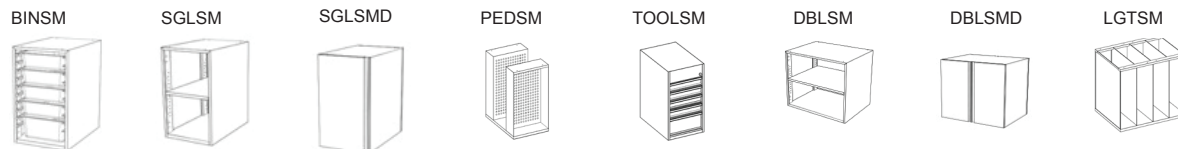

Note: Cargo carts ship KD: Storage modules are shipped assembled except doors need to be attached onsite when applicable.
 Freight Class 150 Origin zip 49548
 * S - Standard Lead Time 4-6 weeks

Explorer Series®

cargo cart configured

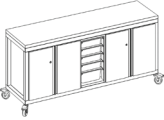
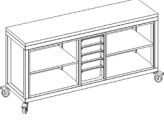
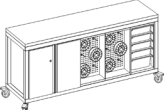
DESCRIPTION	ITEM #	D	W	H	PRICE	SHIP WT.	LEAD TIME*
Cargo Cart with 22d x 77w butcher block top, 1 double storage module with doors, 1 bin storage module, 1 double storage module with doors and locking casters.	CG2D2BD2.2277	22"	77.5"	35.5"	\$6460	409	*
							
Cargo Cart with 22d x 77w butcher block top, 1 double storage module without doors, 1 bin storage module, 1 double storage module without doors and locking casters.	CG2S2BS2.2277	22"	77.5"	35.5"	\$5572	367	*
							
Cargo Cart with 22d x 77w butcher block top, 1 double storage module with doors, 2 peg board storage module, 1 bin storage module and locking casters.	CG2D2PPB.2277	22"	77.5"	35.5"	\$6474	400	*
							

to order
 1. Item Number
 2. Paint Finish
 See paint finish options for frame below

example
CG2BBBL2.2246 - GA
 ITEM NUMBER PAINT FINISH
 please separate each item with a dash

storage modules platinum finish only

MODEL	DESCRIPTION
B = BINSM	Bin Storage Module- 14.7"W x 21.75"D x 24.5"H with bins Four - 4"H x 20.875"L x 12.74"W and One - 6"H x 20.875"L x 12.74"W
S = SGLSM	Single Storage Module - 14.7"W x 21.75"D x 24.5"H
D = SGLSMD	Single Storage Module w/ locking doors - 14.7"W x 21.75"D x 24.5"H
P = PEGSM	Peg Board Module - 14.7"W x 21.75"D x 24.5"H
T = TOOLSM	Tool Storage Module - 14.7"W x 21.75"D x 24.5"H
S2 = DBLSM (uses 2 positions)	Double Storage Module without doors - 29.4"W x 21.75"D x 24.5"H
D2 = DBLSMD (uses 2 positions)	Double Storage Module w/ locking doors - 29.4"W x 21.75"D x 24.5"H
L2 = LGFTSM (uses 2 positions)	Large Format Storage Module - 29.4"W x 21.75"D x 24.5"H Large Format Storage Module can only be used with CG2 partial top model.

paint finish options for frame

MODEL	DESCRIPTION
GA	Green Apple
EN	Navy
P2	Textured Platinum

to order additional bins

MODEL	DESCRIPTION	PRICE
BINPK46	Clear Tote Bin Pack - Four - 4"H x 20.875"L x 12.74"W and One - 6"H x 20.875"L x 12.74"W	\$274
BINPK4	Clear Tote Bin - 4"H x 20.875"L x 12.74"W Pack of 6	\$308
BINPK6	Clear Tote Bin - 6"H x 20.875"L x 12.74"W Pack of 6	\$412

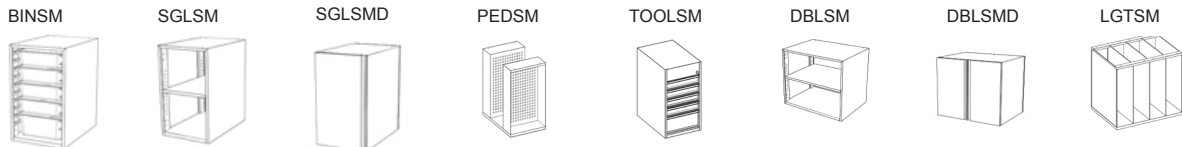

Note: Cargo carts ship KD: Storage modules are shipped assembled except doors need to be attached onsite when applicable.
 Freight Class 150 Origin zip 49548

* S - Standard Lead Time 4-6 weeks

[Return to Table of Contents](#)

Explorer Series®

cargo cart configured

DESCRIPTION	ITEM #	D	W	H	PRICE	SHIP WT.	LEAD TIME*
Cargo Cart with 22d x 77w butcher block top, 1 double storage module with door, 1 single storage module with doors, 1 double storage module with doors and locking casters.	CG2D2DD2.2277	22"	77.5"	35.5"	\$6310	421	*

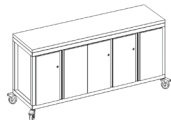

Cargo Cart with 22d x 77w butcher block top, 1 double storage module without doors, 1 single storage module without doors, 1 double storage module without doors and locking casters.	CG2S2SS2.2277	22"	77.5"	35.5"	\$5218	368	*
---	---------------	-----	-------	-------	--------	-----	---

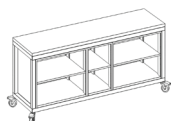

to order

1. Item Number
2. Paint Finish

See paint finish options for frame below

example **CG2BBBL2.2246 - GA**

ITEM NUMBER PAINT FINISH

please separate each item with a dash

storage modules platinum finish only

MODEL	DESCRIPTION
B = BINSM	Bin Storage Module- 14.7"W x 21.75"D x 24.5"H with bins Four - 4"H x 20.875"L x 12.74"W and One - 6"H x 20.875"L x 12.74"W
S = SGLSM	Single Storage Module - 14.7"W x 21.75"D x 24.5"H
D = SGLSMD	Single Storage Module w/ locking doors - 14.7"W x 21.75"D x 24.5"H
P = PEGSM	Peg Board Module - 14.7"W x 21.75"D x 24.5"H
T = TOOLSMD	Tool Storage Module - 14.7"W x 21.75"D x 24.5"H
S2 = DBLSM (uses 2 positions)	Double Storage Module without doors - 29.4"W x 21.75"D x 24.5"H
D2 = DBLSMD (uses 2 positions)	Double Storage Module w/ locking doors - 29.4"W x 21.75"D x 24.5"H
L2 = LGFTSM (uses 2 positions)	Large Format Storage Module - 29.4"W x 21.75"D x 24.5"H Large Format Storage Module can only be used with CG2 partial top model.

paint finish options for frame

MODEL	DESCRIPTION
GA	Green Apple
EN	Navy
P2	Textured Platinum

to order additional bins

MODEL	DESCRIPTION	PRICE
BINPK46	Clear Tote Bin Pack - Four - 4"H x 20.875"L x 12.74"W and One - 6"H x 20.875"L x 12.74"W	\$274
BINPK4	Clear Tote Bin - 4"H x 20.875"L x 12.74"W Pack of 6	\$308
BINPK6	Clear Tote Bin - 6"H x 20.875"L x 12.74"W Pack of 6	\$412

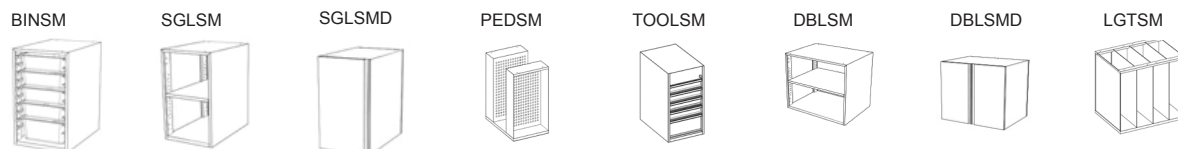

Note: Cargo carts ship KD: Storage modules are shipped assembled except doors need to be attached onsite when applicable.

Freight Class 150 Origin zip 49548

* S - Standard Lead Time 4-6 weeks

Explorer Series®

cargo cart build your own

DESCRIPTION	ITEM #	D	W	H	PRICE	SHIP WT.	LEAD TIME*
Cargo Cart with 22d x 46w butcher block top and locking casters. Add up to 5 storage modules, sold separately.	CG1xxxxx.2246	22"	77.5"	35.5"	\$2688	190	S



Cargo Cart with 22d x 77w butcher block top and locking casters. Add up to 5 storage modules (L2 large format storage model not an option for this unit), sold separately.	CG2xxxxx.2277	22"	77.5"	35.5"	\$2988	230	S
--	---------------	-----	-------	-------	--------	-----	---

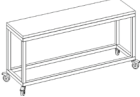

to order How to Build Your Own item number
 replace "x" with storage module item number listed below.
 Leave "x" for empty modules (positions are laid out left to right)

example (bin storage module, single storage module without door, ped board module, double storage module with locking doors)

B	S	P	D	2
P1	P2	P3	P4	P5

Configurations: Five 14.7"W Modules
 Two 29.4"W Modules + One 14.7"W Module
 One 29.4"W Module + Three 14.7"W Modules use 2 positions

to order 1. Item Number
 2. Paint Finish
 See paint finish options for frame below

example CG1BSPD2.2277 - GA
 ITEM NUMBER PAINT FINISH
 please separate each item with a dash

storage modules platinum finish only

MODEL	DESCRIPTION	PRICE	SHP WT
B = BINSM	Bin Storage Module- 14.7"W x 21.75"D x 24.5"H with clear tote bin pack Four - 4"H x 20.875"L x 12.74"W and One - 6"H x 20.875"L x 12.74"W	\$908	37
S = SGLSM	Single Storage Module without door- 14.7"W x 21.75"D x 24.5"H	\$554	38
D = SGLSMD	Single Storage Module w/ locking door - 14.7"W x 21.75"D x 24.5"H	\$758	49
P = PEGSM	Peg Board Module - 14.7"W x 21.75"D x 24.5"H (Doesn't include pegs or spools)	\$648	31
T = TOOLSM	Tool Storage Module - 14.7"W x 21.75"D x 24.5"H	\$1098	
S2 = DBLSM (uses 2 positions)	Double Storage Module without doors - 29.4"W x 21.75"D x 24.5"H	\$838	50
D2 = DBLSMD (uses 2 positions)	Double Storage Module w/ locking doors - 29.4"W x 21.75"D x 24.5"H	\$1282	71
L2 = LGFTSM (uses 2 positions)	Large Format Storage Module - 29.4"W x 21.75"D x 24.5"H Large Format Storage Module can only be used with CG2 partial top model.	\$898	72

to order additional bins

MODEL	DESCRIPTION	PRICE
BINPK46	Clear Tote Bin Pack - Four - 4"H x 20.875"L x 12.74"W and One - 6"H x 20.875"L x 12.74"W	\$274
BINPK4	Clear Tote Bin - 4"H x 20.875"L x 12.74"W Pack of 6	\$308
BINPK6	Clear Tote Bin - 6"H x 20.875"L x 12.74"W Pack of 6	\$412

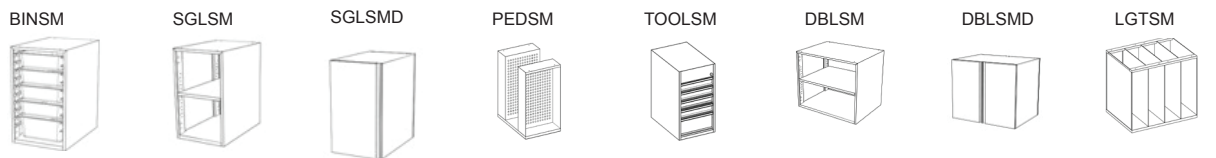

Note: Cargo carts ship KD: Storage modules are shipped assembled except doors need to be attached onsite when applicable.
 Freight Class 150 Origin zip 49548

* S - Standard Lead Time 4-6 weeks

Explorer Series®

cargo cart build your own

DESCRIPTION	ITEM #	D	W	H	PRICE	SHIP WT.	LEAD TIME*
Cargo Cart with 28d x 77w butcher block top, 6" overhang on one side and locking casters. Add up to 5 storage modules (L2 large format storage model not an option for this unit), sold separately.	CG3xxxxx.2877	28"	77.5"	35.5"	\$3138	230	S



How to Build Your Own item number
 replace "x" with storage module item number listed below.
 Leave "x" for empty modules (positions are laid out left to right)

CG1 or CG2
 1. Position 1
 2. Position 2
 3. Position 3
 4. Position 4
 5. Position 5

example (bin storage module, single storage module without door, ped board module, double storage module with locking doors)

B	S	P	D	2
P1	P2	P3	P4	P5

Configurations: Five 14.7"W Modules
 Two 29.4"W Modules + One 14.7"W Module
 One 29.4"W Module + Three 14.7"W Modules
 29.4"W Modules use 2 positions

to order

1. Item Number
 2. Paint Finish
See paint finish options for frame below

example **CG1BSPD2.2277 - GA**

CG1BSPD2.2277	-	GA
ITEM NUMBER		PAINT FINISH

please separate each item with a dash

storage modules platinum finish only

MODEL	DESCRIPTION	PRICE	SHW WT
B = BINSM	Bin Storage Module- 14.7"W x 21.75"D x 24.5"H with clear tote bin pack Four - 4"H x 20.875"L x 12.74"W and One - 6"H x 20.875"L x 12.74"W	\$908	37
S = SGLSM	Single Storage Module without door- 14.7"W x 21.75"D x 24.5"H	\$554	38
D = SGLSMD	Single Storage Module w/ locking door - 14.7"W x 21.75"D x 24.5"H	\$758	49
P = PEGSM	Peg Board Module - 14.7"W x 21.75"D x 24.5"H (Doesn't include pegs or spools)	\$648	31
T = TOOLSM	Tool Storage Module - 14.7"W x 21.75"D x 24.5"H	\$1098	
S2 = DBLSM (uses 2 positions)	Double Storage Module without doors - 29.4"W x 21.75"D x 24.5"H	\$838	50
D2 = DBLSMD (uses 2 positions)	Double Storage Module w/ locking doors - 29.4"W x 21.75"D x 24.5"H	\$1282	71
L2 = LGFTSM (uses 2 positions)	Large Format Storage Module - 29.4"W x 21.75"D x 24.5"H Large Format Storage Module can only be used with CG2 partial top model.	\$898	72

to order additional bins

MODEL	DESCRIPTION	PRICE
BINPK46	Clear Tote Bin Pack - Four - 4"H x 20.875"L x 12.74"W and One - 6"H x 20.875"L x 12.74"W	\$274
BINPK4	Clear Tote Bin - 4"H x 20.875"L x 12.74"W Pack of 6	\$308
BINPK6	Clear Tote Bin - 6"H x 20.875"L x 12.74"W Pack of 6	\$412

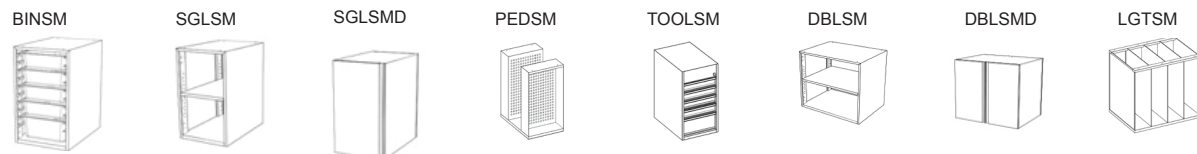

Note: Cargo carts ship KD: Storage modules are shipped assembled except doors need to be attached onsite when applicable.

Freight Class 150 Origin zip 49548

* S - Standard Lead Time 4-6 weeks

Explorer Series®

tall storage cart - specifications

OVERALL DIMENSIONS

47x26.5x66

BODY

Construction

18 Gauge Formed and Welded Steel

MARKERBOARD

Dimensions

47Wx41.5H, Bottom 24.5 from floor

Surface

Non-Ghosting Powder Coat

STORAGE

4 Shelf Configuration (Fixed)

- Shelf Dimension

45Wx21.5Dx14H

8 Shelf Configuration (Optional)

- Shelf Dimension

45Wx21.5Dx6.5H

- Fits 24, 6in bins

3 bins per shelf

8 shelves

6in Bin

- Dimensions

20.875x12.75x6

- 20.6 qt

- Clear

- Polycarbonate

- Dishwasher Safe

- Freezer Safe

CASTERS

4 - 3" Locking Directional Total Lock

- High Strength Steel

- TPU Tread, Non-Marking

- Corrosion Resistant

- 250lb load rating (per caster)

SPECIFICATIONS

Max Load

TBD

Paint

Textured Powder coat



FRONT VIEW

SIDE VIEW

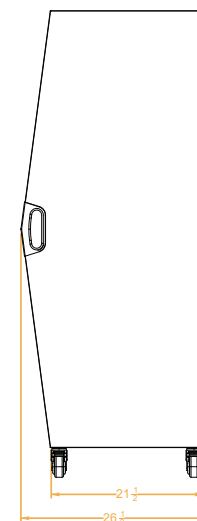
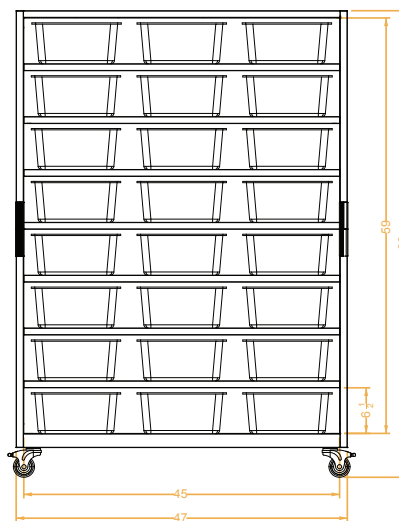

BACK VIEW

TOP VIEW

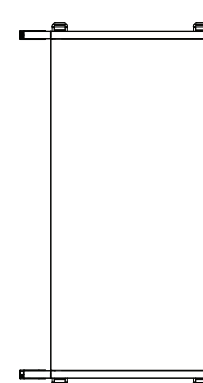
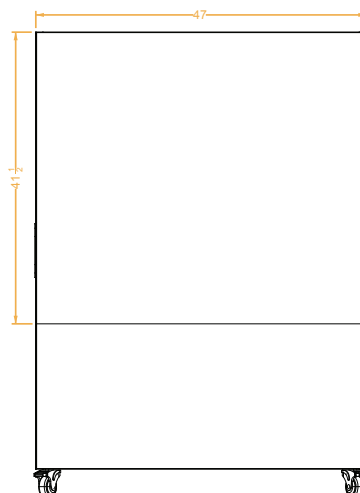

Explorer Series®

cubby storage cart - specifications

OVERALL DIMENSIONS

47x26.5x38

BODY

Construction

18 Gauge Formed and Welded Steel

MARKERBOARD

Dimensions

47Wx34H, Bottom 4IN from floor

Surface

Non-Ghosting Powder Coat

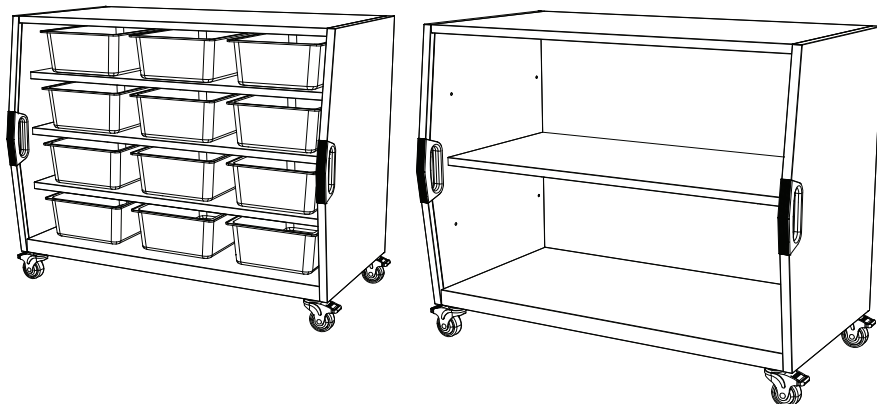

STORAGE

2 Shelf Configuration (Fixed)

Shelf Dimension: 45Wx21.5Dx15H

4 Shelf Configuration (Optional)

Shelf Dimension: 45Wx21.5Dx17H

- Fits 12, 6in bins
- 3 bins per shelf
- 4 shelves

6in Bin

Dimensions: 20.875x12.75x6

- 20.6 qt
- Clear
- Polycarbonate
- Dishwasher Safe
- Freezer Safe

CASTERS

4 - 3" Locking Directional Total Lock

- High Strength Steel
- TPU Tread, Non-Marking
- Corrosion Resistant
- 250lb load rating (per caster)

SPECIFICATIONS

Max Load

TBD

Paint

Textured Powder coat

FRONT VIEW

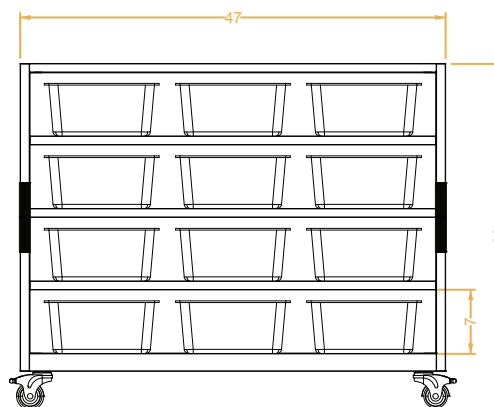

TOP VIEW

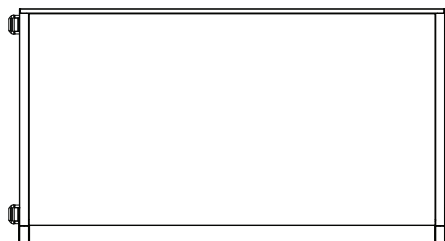

BACK VIEW

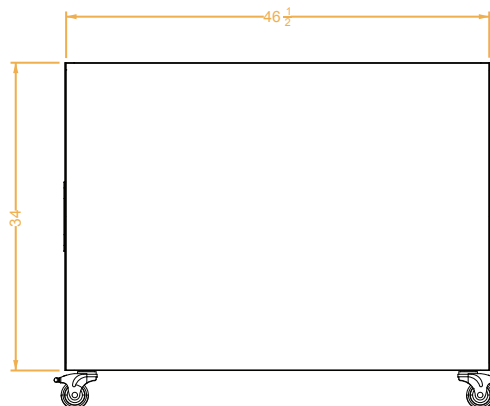

SIDE VIEW

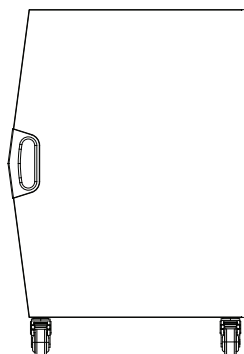

Explorer Series®

pack cart - specification

OVERALL DIMENSIONS

52x26.5x66

BODY

Construction

18 Gauge Formed and Welded Steel

MARKERBOARD

Dimensions

52Wx41.5H, Bottom 24.5 from floor

Surface

Non-Ghosting Powder Coat

STORAGE

Inside Dimension

45x21.5x59

HOOKS

Dimensions

- Lower Hook: 30H

- Upper Hook: 65.5H

Construction

- Welded Steel Construction

- 2 - 6 Hook independent swiveling units

- Max Load per hook: TBD

- 360 degree swivel

- Powder coated

CASTERS

4 - 3" Locking Directional Total Lock

- High Strength Steel

- TPU Tread, Non-Marking

- Corrosion Resistant

- 250lb load rating (per caster)

SPECIFICATIONS

Max Load

- TBD

Paint

- Textured Powder coat

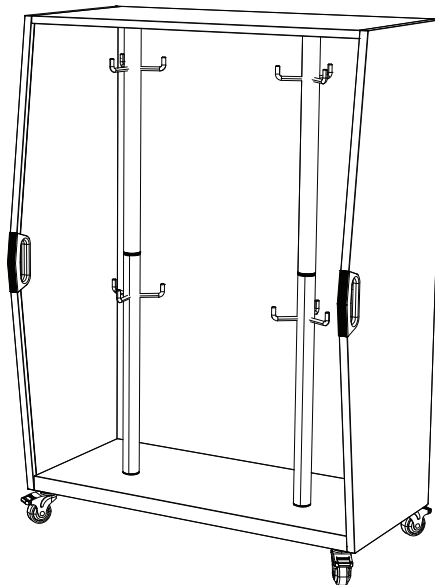

FRONT VIEW

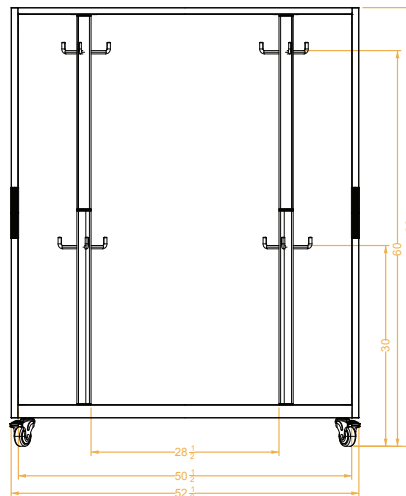

BACK VIEW

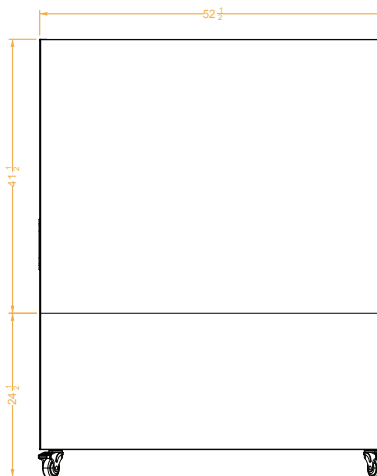

SIDE VIEW

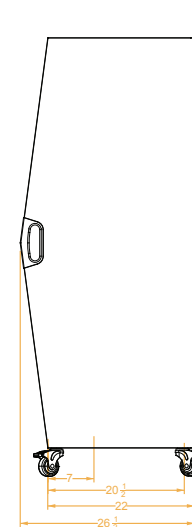





TOP VIEW

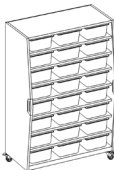

Explorer Series®

storage carts

DESCRIPTION	ITEM #	D	W	H	PRICE	SHIP WT.	LEAD TIME*
Cubby Storage Cart w/ 2 shelves, magnetic white board backing & locking casters.	CUB01	26.5"	47"	38"	\$2568	193	S
							
Cubby Storage Cart w/ 1 fixed and 2 adjustable shelves, 12 - 6" bins, magnetic white board backing & locking casters	CUB02	26.5"	47"	38"	\$3498	193	S
							
Tall Storage Cart w/ 1 fixed and 2 adjustable shelves, magnetic white board backing & locking casters	TSTOR01	26.5"	47"	66"	\$3688	264	S
							
Tall Storage Cart w/ 1 fixed and 6 adjustable shelves, 24 - 6" bins magnetic white board backing & locking casters	TSTOR02	26.5"	47"	66"	\$5488	326	S
							
Pack Storage Cart w/ 2 rotating columns w/ 12 hooks, magnetic white board backing & locking casters	PACKCART	26.5"	52"	66"	\$3418	283	S
							

to order	1. Item Number	CUB01	-	P2 (TEXTURED PLATINUM ONLY)
	2. Paint Finish			
	<i>See paint finish options for frame below</i>			
		<small>ITEM NUMBER</small>		<small>PAINT FINISH</small>
		<small>please separate each item with a dash</small>		

to order additional bins

MODEL	DESCRIPTION	PRICE
BINPK6	Clear Tote Bin - 6"H x 20.875"L x 12.74"W Pack of 6	\$412

Ships fully assembled including casters
 Freight Class 175 Origin zip 49548
 * S - Standard Lead Time 4-6 weeks

Explorer Series®

introduction - think nook™



THINK NOOK™

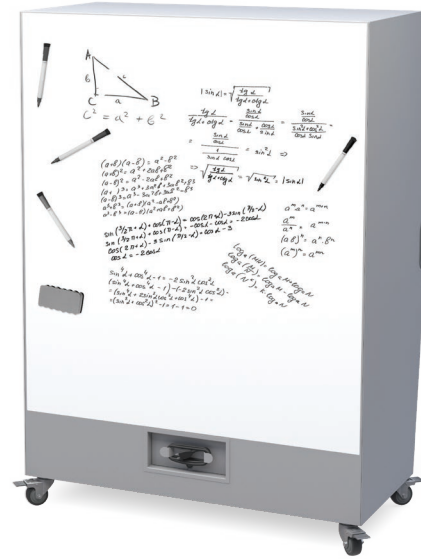

MARKER BOARD BACK

General

Academic success goes hand in hand with social and emotional learning. As such, the emerging design criteria for today's collaborative classroom should contain a multitude of tools designed to help teachers build their students strengths, enhance their learning styles and support healthy transitions between group work and individualized learning. The Explorer Series® Think Nook™ is the perfect solution for students who need quiet time to think, read or simply recharge.

Explorer Series®

think nook™ - specifications

OVERALL DIMENSIONS

47x26.5x66

BODY

Construction

18 Gauge Formed and Welded Steel

MARKERBOARD

Dimensions

47Wx41.5H, Bottom 24.5 from floor

Surface

Non-Ghosting Powder Coat

POWER (OPTIONAL)

MiniTap

- Manufacturer : Byrne

- 1 110v Power, 2 US Rating

13 amps, 125 volts

Cord Length

8ft

SEAT

Inside Seat Dimension

44.5x20x49

PAD

- Seat

1in 2880 Polyurethane Foam

- Back

.25in 2880 Polyurethane Foam

- Headboard

.25in 2880 Polyurethane Foam

MAX LOAD

TBD

FABRIC

COM Yardage Requirements

- Seat: 1.75 Linear Yards

- Back: 1.6 Linear Yards

- Headboard: 1.75 Linear Yards

STORAGE

Inside dimensions

- Outer cubby

15.5Wx7Hx20D

- Center Cubby

12Wx7Hx20D

CASTERS

4 - 3" Locking Directional Total Lock

- High Strength Steel

- TPU Tread, Non-Marking

- Corrosion Resistant

- 250lb load rating (per caster)

SPECIFICATIONS

Max Load

TBD

Paint

Textured Powder coat

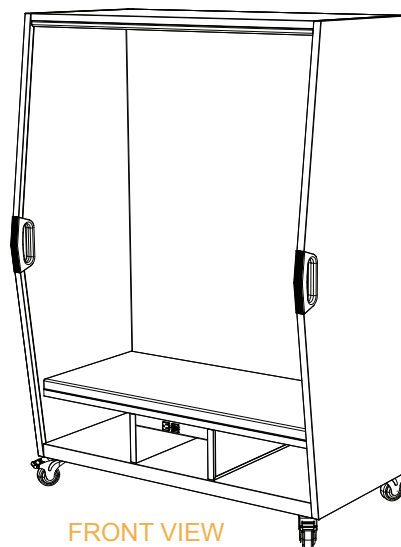

FRONT VIEW

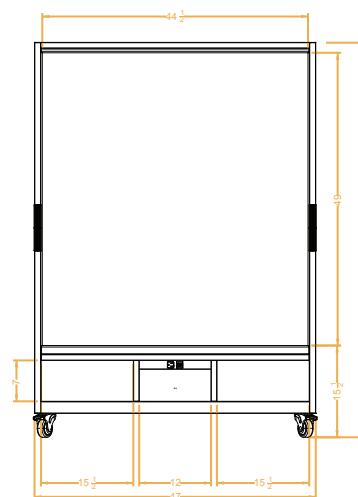

BACK VIEW

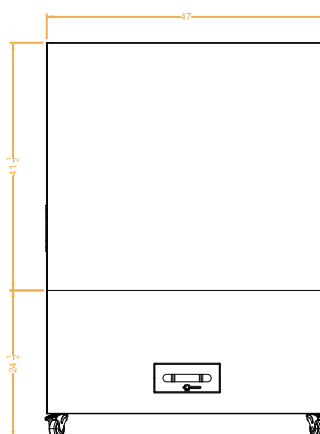

TOP VIEW

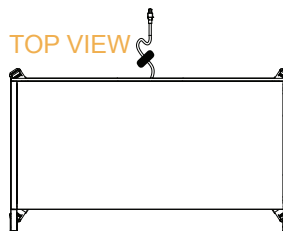

SIDE VIEW

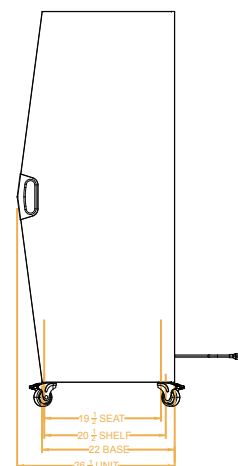

Explorer Series®

think nook™ - fabric planner

For Purchase Order Number:

Project Name:

Headboard: 1 Linear Yard

Fabric Manufacturer:

Fabric Pattern:

Fabric Color:

Back: 2 Linear Yards

Fabric Manufacturer:

Fabric Pattern:

Fabric Color:

Seat: 1 Linear Yard

Fabric Manufacturer:

Fabric Pattern:

Fabric Color:

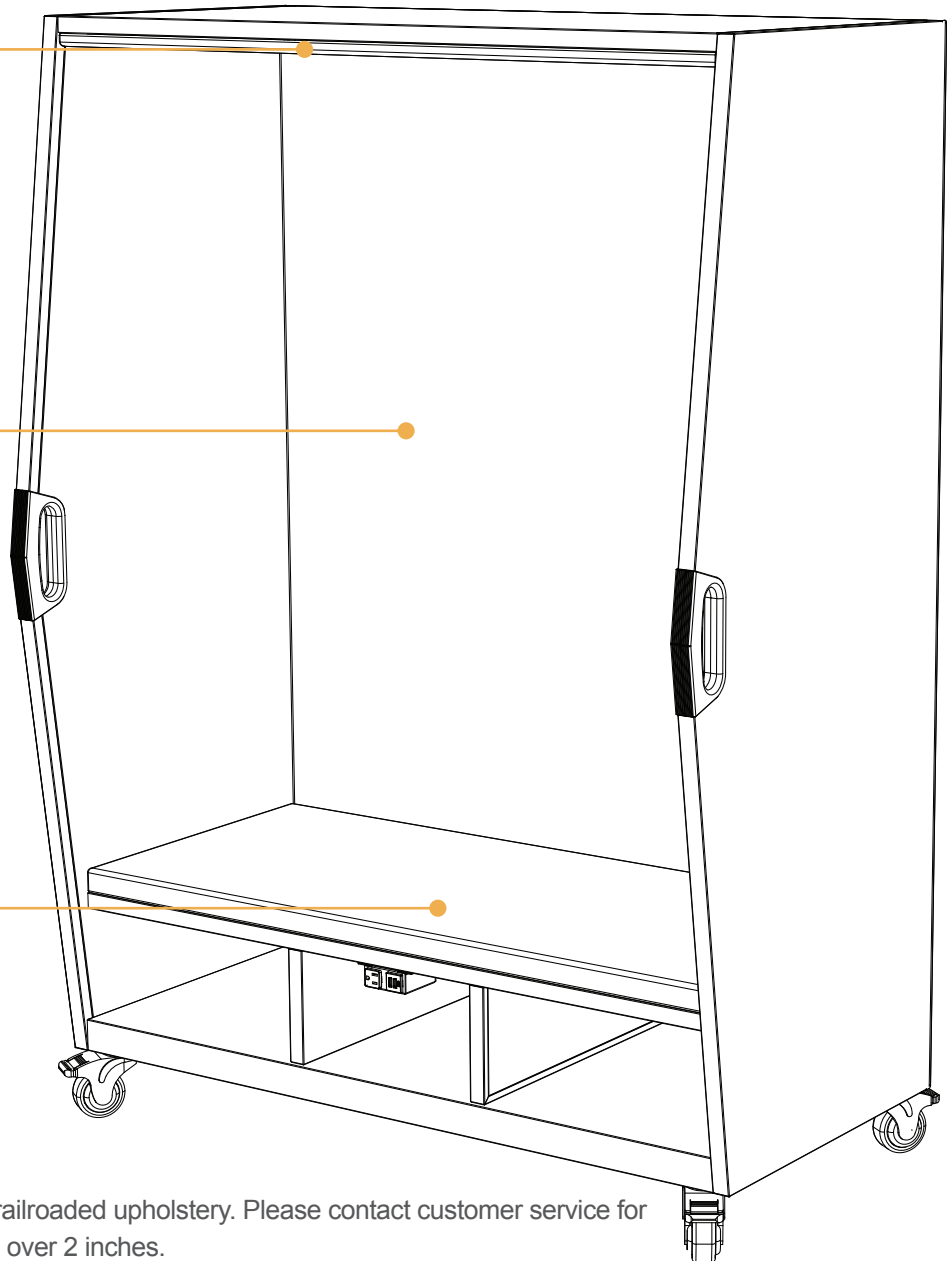

Yardage requirements are for non-railroded upholstery. Please contact customer service for railroding requirements or repeats over 2 inches.

This form must accompany your order. Send completed form to sales@haskelloffice.com

The lead-time of your order is directly related to when the COM fabric is received.



Please ship COM to: Haskell, 3770 Hagen Dr., Wyoming, MI 49548

Clearly label all materials with the dealer name, project name, and purchase order number.

[Download the COM Fabric Planner for Think Nook™](#)

Explorer Series®

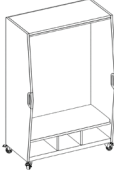
think nook™

DESCRIPTION	ITEM #	NOTE	D	W	H	COM PRICE	SHIP WT.	LEAD TIME*
Nook w/ upholstered seat, back & ceiling, cubby storage, magnetic white board backing & locking casters	THKNK01	Go to www.haskell.com to download COM form COM form must accompany your order	26.5"	47"	66"	\$4924	309	*
								
Nook w/ upholstered seat, back & ceiling, cubby storage, power unit, magnetic white board backing & locking casters	THKNK01E	Go to www.haskell.com to download COM form COM form must accompany your order	26.5"	47"	66"	\$5488	309	*
								

to order	1. Item Number	THKNK01E	-	P2	-	OR	COM
	2. Paint Finish	ITEM NUMBER		PAINT FINISH Textured Platinum (only option)		FABRIC CODE	COM
	3. Fabric Code or COM					Customer Supplying Material	

please separate each item with a dash
Go to www.haskell.com to download COM form. COM form must accompany your order.

Note: COM Requirements: Headboard 1 linear yard; back 2 linear yards; seat 1 linear yard. Yardage requirements are for non-railroaded upholstery. Please contact customer service for railroading requirements or repeats over 2 inches.

Ships fully assembled including casters
 Freight Class 175 Origin zip 49548
 * Instock fabric - S – Standard Lead Time 4-6 weeks / COM fabric - 4-6 weeks upon receipt of customer's material

Fuzion™ Series

introduction



General

Haskell's unique sit to stand student desk is the right choice for today's active learning classroom. Our 20 year warranty on the height adjustable column insures years of uninterrupted use in the classroom promoting a healthier learning environment while fostering greater student engagement.

Whether sitting in a chair or standing, nothing gets in your way for maximum comfort. The FuZion™ has two east/west bars and north/south bars for strength and stability.

While many sit to stand desks bounce and are springy (causing the product to wear down after just a few years), our Hydraulic SureLock Construction prevents bounce and slippage of the height adjust.

The addition of an easy grip handle for raising and lowering the sit to stand desk makes height adjustment simple and fast.







The FuZion™ Sit to Stand Desk offers a large laptop storage area under the work surface.

A multi-purpose storage area on the top of the desk helps you maximize your work area and securely hold your tablet for viewing videos or reading.

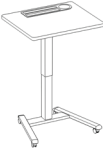
The water bottle holder helps keep your classroom organized and minimize spills on the floor and on technology while not sacrificing work space.

Fuzion™ Series

sit to stand

DESCRIPTION	ITEM #	D	W	H	3MM EDGE	SHIP WT.	LEAD TIME*
Fuzion™ Sit to Stand, 22x26, Formica fog (FF) laminate, fog (FG) edge, platinum paint finish Y base, grommet, locking casters 	2FZPN7GQS.2226.PL.FF.FG.0	22"	26"	28 ¼" - 42"	\$830	40	QS
Sit to Stand, 22x26, standard Wilsonart laminate, platinum paint finish Y base, locking casters 	2FZPN7.2226.PL	22"	26"	28 ¼" - 42"	\$975	40	S
Sit to Stand, 22x26, standard Wilsonart laminate, platinum paint finish Y base, grommet, locking casters 	2FZPN7G.2226.PL	22"	26"	28 ¼" - 42"	\$1010	40	S
Fuzion Sit to Stand, 24x28.5, standard Wilsonart laminate, platinum paint finish Y base, locking casters 	2FZPN7.2428.PL	24"	28.5"	28 ¼" - 42"	\$1018	40	S
Fuzion Sit to Stand, 24x28.5, standard Wilsonart laminate, platinum paint finish Y base, grommet, locking casters 	2FZPN7G.2428.PL	24"	28.5"	28 ¼" - 42"	\$1050	40	S
Large Sit to Stand, 28x36, standard Wilsonart laminate, platinum paint finish base, locking casters. Can be used as an ADA desk. 	FZPN8.2836.PL	28"	36"	28 ¼" - 42"	\$1244	62	S
Large Sit to Stand, 28x36, standard Wilsonart laminate, platinum paint finish base, grommet, locking casters. Can be used as an ADA desk. 	FZPN8G.2836.PL	28"	36"	28 ¼" - 42"	\$1278	62	S

to order	1. Item Number	FZPN7G.2226-PL				-	GL	-	63	-	BKSHF
	2. Laminate	ITEM NUMBER					LAMINATE		EDGE FINISH		OPTIONS
	3. Edge Finish	PL Platinum Paint Finish (only option)									
	4. Options	<i>please separate each item with a dash</i>									

options

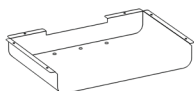

MODEL	DESCRIPTION	PRICE
BKSHF	BOOK SHELF / LAPTOP HOLDER <small>Only available in platinum</small>	\$94



FZPNMOD.2226	MODESTY PANEL FOR 22X26 SIT TO STAND	\$144
--------------	--------------------------------------	-------

Fuzion™ Series

ADA height adjustable desk

DESCRIPTION	ITEM #	D	W	H	3MM EDGE	SHIP WT.	LEAD TIME*
Fuzion ADA height adjustable desk, 30x36, standard Wilsonart laminate, platinum paint finish base, locking casters. 	FZPN9.3036.PL	30"	36"	28 1/4" - 42"	\$1320	62	S
Fuzion ADA height adjustable desk, 30x36, standard Wilsonart laminate, platinum paint finish base, grommet, locking casters. 	FZPN9G.3036.PL	30"	36"	28 1/4" - 42"	\$1358	62	S

- to order
1. Item Number
 2. Laminate
 3. Edge Finish
 4. Options

example **FZPN9G.3036-PL - H - I**

ITEM NUMBER LAMINATE EDGE FINISH
 PL Platinum Paint Finish (only option)

please separate each item with a dash







options

MODEL	DESCRIPTION	PRICE
BKSHF	BOOK SHELF / LAPTOP HOLDER <small>Only available in platinum</small>	\$94

FZPNMOD	FOR 22X26 SIT TO STAND	\$144
---------	------------------------	-------

Fuzion™ Series

teacher's lectern with storage

DESCRIPTION	ITEM #	D	W	H	3MM EDGE	SHIP WT.	LEAD TIME*
Teacher's Lectern, 22x26, hydraulic lift, locking storage cabinet, platinum Y base, locking casters 	2FZTL7.2226.PL	22"	26"	28 1/4" - 42"	\$1465	64	S
Teacher's Lectern, 22x26, hydraulic lift, grommet, locking storage cabinet, platinum Y base, locking casters 	2FZTL7G.2226.PL	22"	26"	28 1/4" - 42"	\$1522	64	S
Fuzion Teacher's Lectern, 24x28, hydraulic lift, locking storage cabinet, platinum Y base, locking casters 	2FZTL7.2428.PL	22"	28.5"	28 1/4" - 42"	\$1528	64	S
Fuzion Teacher's Lectern, 24x28, hydraulic lift, grommet, locking storage cabinet, platinum Y base, locking casters 	2FZTL7G.2428.PL	22"	28.5"	28 1/4" - 42"	\$1560	64	S
Large Teacher's Lectern, 28x36, hydraulic lift, locking storage cabinet, platinum base, locking casters 	FZTL8.2836.PL	28"	36"	28 1/4" - 42"	\$1754	86	S
Large Teacher's Lectern, 28x36, hydraulic lift, grommet, locking storage cabinet, platinum base, locking casters 	FZTL8G.2836.PL	28"	36"	28 1/4" - 42"	\$1788	86	S

to order

1. Item Number
2. Paint Finish
3. Laminate
4. Edge Finish

example

2FZTL7.2226 - PL - H - I

ITEM NUMBER PAINT FINISH LAMINATE EDGE FINISH

PL Platinum Paint Finish (only option)





please separate each item with a dash

options

MODEL	DESCRIPTION
PL	Platinum Only available in platinum

Fuzion™ Series

teacher's desk

DESCRIPTION	ITEM #	D	W	H	3MM EDGE	SHIP WT.	LEAD TIME*
<p>Fuzion™ Wave shape, right handed (podium connects on right convex side) static t-leg, 30x60, modesty panel, grommet, platinum paint and casters. Concave podium ordered separately.</p> 	FZRWAVEC.3060.PL	30"	60"	29.5"	\$1620	94	S
<p>Fuzion™ Wave shape, left handed (podium connects on left convex side) static t-leg, 30x60, modesty panel, grommet, platinum paint and casters. Concave podium ordered separately.</p> 	FZLWAVEC.3060.PL	30"	60"	29.5"	\$1620	94	S
<p>Fuzion™ Wave concave podium, 31x36, sit to stand hydraulic lift, platinum paint finish Y base and casters</p> 	2FZWVBP.2630.PL	31"	36"	28 ¼" - 42"	\$1124	54	S
<p>Fuzion™ mobile pedestal, tray/box/file, platinum paint</p> 	FZTBFPEL-PL	20.78"	14.75"	22.9"	\$790	48	S
<p>Center drawer, 23" w, platinum paint</p>	CD27-PL	17 ⅞"	23"	3"	\$320	5	S

to order

1. Item Number
2. Laminate
3. Edge Finish

example



FZRWAVE.3060.PL - H - I

ITEM NUMBER LAMINATE EDGE FINISH
PL Platinum Paint Finish (only option)

please separate each item with a dash

Fuzion™ Series

teacher's desk

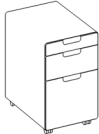

DESCRIPTION	ITEM #	NOTES	D	W	H	PRICE	SHIP WT.	LEAD TIME*
Rectangular shape, static t-leg, modesty panel, grommet, platinum paint and casters 	FZRECTC.2448.PL		24"	48"	29.5"	\$1384	78	S
	FZRECTC.2460.PL		24"	60"	29.5"	\$1468	86	S
	FZRECTC.3048.PL		30"	48"	29.5"	\$1484	86	S
	FZRECTC.3060.PL		30"	60"	29.5"	\$1554	94	S
D shape podium, sit to stand hydraulic lift, platinum paint finish Y base and casters 	2FZDP24.PL		24"	30"/24"	28 1/4" - 42"	\$1034	44	S
	2FZDP30.PL		30"	36"/30"	28 1/4" - 42"	\$1088	\$60	S
Fuzion™ mobile pedestal, tray/box/file, platinum paint 	FZTBFPEP-PL		20.78"	14.75"	22.9"	\$790	48	S
Center drawer, 23" w, platinum paint	CD27-PL		17 1/8"	23"	3"	\$320	5	S

to order	1. Item Number	FZRECTC.2448-PL	-	H	-	I
	2. Laminate	ITEM NUMBER		LAMINATE		EDGE FINISH
	3. Edge Finish	PL Platinum Paint Finish (only option)				

example please separate each item with a dash

Fuzion™ Series

teacher's desk

DESCRIPTION	ITEM #	NOTES	D	W	H	PRICE	SHIP WT.	LEAD TIME*
Kidney shape, static t-leg, 33X60, modesty panel, grommet, platinum paint and casters 	FZKIDC.3360-PL		33"	60"	29.5"	\$1864	98	S
3/4 moon shape podium, 27x30, sit to stand hydraulic lift, platinum paint finish Y base and casters 	FZMP.2730-PL		27"	30"	28 1/4" - 42"	\$1088	40	S
Fuzion™ mobile pedestal, tray/box/file, platinum paint 	FZTBFPE-PL		20.78"	14.75"	22.9"	\$790	48	S
Center drawer, 23" w, platinum paint	CD27-PL		17 1/8"	23"	3"	\$320	5	S

to order

1. Item Number
2. Laminate
3. Edge Finish

example

FZKIDC.3360-PL - H - I

ITEM NUMBER LAMINATE EDGE FINISH

PL Platinum Paint Finish (only option)

please separate each item with a dash

Fuzion™ Series

teacher's desk

DESCRIPTION	ITEM #	NOTES	D	W	H	PRICE	SHIP WT.	LEAD TIME*
Fuzion Mobile Teacher's Desk 24" x 60" with Box/Box/File mobile pedestal, T- legs and modesty panel	FZTD.2460.PL		24"	60"	29"	\$1578	107	S
Fuzion Mobile Teacher's Desk 24" x 66" D-shaped peninsula top with Box/Box/File mobile pedestal, T- legs and modesty panel	FZTDD.2466.PL		24"	66"	29"	\$1678	107	S

to order

1. Item Number
2. Laminate
3. Edge Finish

example

FZKIDC.3360-PL - H - I

ITEM NUMBER LAMINATE EDGE FINISH

PL Platinum Paint Finish (only option)

please separate each item with a dash

Marathon Series

introduction



General

All Marathon Desking Units are 30" H. All worksurfaces are laminate wood core tops at 1 3/16" thick and are available with a 3mm edge. All Marathon Desking Units come with center drawers and central locking systems.

Assembly

All units ship without chrome legs attached. Legs can attach with no tools, but come with an added bracket that can be screwed to the bottom of the pedestal for additional support. Interior drawer accessories are field-installed only.

Locks

Marathon Desking Units comes standard with a removable core lock for easy reconfiguration on site. Units can be keyed alike to other Haskell products upon request.

Installation

Correct installation should include proper leveling.

Application Considerations

When specifying the units for workstation configurations, note the following points:

*18" D returns can be used for the 66" x 30" or wider single pedestal desks.

*Overstorage Units can not be used on 36" D with overhangs. The 6" overhang is not suitable to support a loaded overstorage unit.

COM

All COM yardage is based on a 54" wide fabric.

Keying Information and Locking Options

All locks feature a removable core which is easily removed on site. All lock cores are interchangeable through all products as cores are universal.

Locks throughout an order or locks within a particular workstation can be keyed alike at no additional charge, if specified when ordering. Keyed Alike means that all locks are identical. To order, specify which products are to be keyed alike and order a "Removable Core Lock Kit" for each group of products to be keyed alike. The specified products will be shipped without lock cores. The cores for each workstation will be packaged separately. All Removable Core Lock Kits are shipped with a control key for removing or inserting lock cores. Note that a control key works only when a lock is in the unlocked position.



Master keys, which operate any removable core lock, are available for \$35 net each.

One control key is provided for each "key alike" order. If additional keys are needed, cost is \$35 net each.

Additional keys can be purchased for \$15 net per key.

Marathon Series

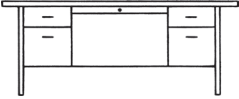
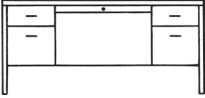
double pedestal desks

DESCRIPTION	ITEM #	D	W	H	3MM EDGE	SHIP WT.	LEAD TIME*
Double Pedestal Desk 6" overhang on side/approach, center drawer w/ central locking system	MDC6036C	36"	60"	30"	\$2435	200	E
	MDC7236C	36"	72"	30"	\$2495	224	E
							
Double Pedestal Desk locks & center drawer w/ central locking system	MDC6030C	30"	60"	30"	\$2816	190	E
							
Table Desk locks & center drawer	MTD7236C	36"	72"	30"	\$2919	198	E
							

to order

1. Item Number
2. Pull Style
3. Paint Finish
4. Edge Finish
5. Leg Finish

example

MDC6036C - FL - 5503 - 4072 - CH99

ITEM NUMBER PULL STYLE PAINT FINISH EDGE FINISH LEG FINISH

please separate each item with a dash

drawer pull options

MODEL	DESCRIPTION
RS	Recessed

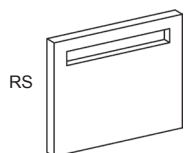

leg finish options

FINISH	DESCRIPTION	PRICE
CH99	Chrome	Standard
Paint Finish #	Painted	10% Upcharge

drawer accessories

MODEL	DESCRIPTION	PRICE
HABDD	Box Drawer Divider	\$72

Marathon Series

single pedestal desks

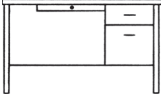
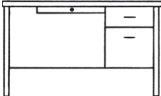
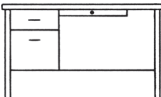
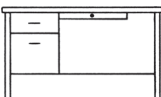
DESCRIPTION	ITEM #	NOTE	D	W	H	3MM EDGE	SHIP WT.	LEAD TIME*
Single Pedestal Desk right b/f pedestal & center drawer w/ central locking system 	MRC4530C	Not applicable for use w/ returns	30"	45"	30"	\$2532	123	E
	MRC6030C	Not applicable for use w/ returns	30"	60"	30"	\$2611	149	E
Single Pedestal Desk right b/f pedestal & center drawer w/ central locking system 	MRC6030C	For use w/18" D return	30"	60"	30"	\$2871	171	E
	MRC7230C	For use w/18" D return	30"	72"	30"	\$2913	192	E
Single Pedestal Desk left b/f pedestal & center drawer w/ central locking system 	MLC4530C	Not applicable for use w/ returns	30"	45"	30"	\$2532	123	E
	MLC6030C	Not applicable for use w/ returns	30"	60"	30"	\$2611	149	E
Single Pedestal Desk left b/f pedestal & center drawer w/ central locking system 	MLC6030C	For use w/18" D return	30"	60"	30"	\$2871	171	E
	MLC7230C	For use w/ 18" D return	30"	72"	30"	\$2913	192	E

to order

1. Item Number
2. Pull Style
3. Paint Finish
4. Edge Finish
5. Leg Finish

example

MRC4530C - FL - 5503 - 4072 - CH99

ITEM NUMBER PULL STYLE PAINT FINISH EDGE FINISH LEG FINISH

please separate each item with a dash

drawer pull options

MODEL	DESCRIPTION
RS	Recessed



RS

leg finish options

FINISH	DESCRIPTION	PRICE
CH99	Chrome	Standard
Paint Finish #	Painted	10% Upcharge

Marathon Series

single pedestal desks w/ overhang

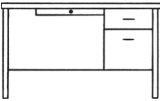
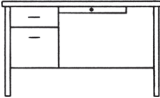
DESCRIPTION	ITEM #	NOTE	D	W	H	3MM EDGE	SHIP WT.	LEAD TIME*
Single Pedestal Desk right b/f pedestal, w/ 6" overhang on approach & center drawer w/ central locking system 	MRC6036C	Not applicable for use w/ returns	36"	60"	30"	\$2883	165	E
Single Pedestal Desk left b/f pedestal, w/ 6" overhang on approach & center drawer w/ central locking system 	MLC6036C	Not applicable for use w/ returns	36"	60"	30"	\$2883	165	E

to order

1. Item Number
2. Pull Style
3. Paint Finish
4. Edge Finish
5. Leg Finish

example

MRC6036C - FL - 5503 - 4072 - CH99

ITEM NUMBER PULL STYLE PAINT FINISH EDGE FINISH LEG FINISH

please separate each item with a dash

drawer pull options

MODEL	DESCRIPTION
RS	Recessed

RS

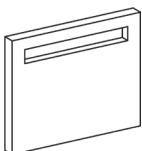



leg finish options

FINISH	DESCRIPTION	PRICE
CH99	Chrome	Standard
Paint Finish #	Painted	10% Upcharge

Marathon Series

returns and credenzas

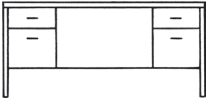
DESCRIPTION	ITEM #	NOTE	D	W	H	3MM EDGE	SHIP WT.	LEAD TIME*
Right Handed Return w/ b/f pedestal 	MER4218C	For use w/ 60" & 72" W	18"	42"	30"	\$1927	87	E
	MER6018C	For use w/ 60" & 72" W	18"	60"	30"	\$1956	107	E
Left Handed Return w/ b/f pedestal 	MEL4218C	For use w/ 60" & 72" W	18"	42"	30"	\$1927	87	E
	MEL6018C	For use w/ 60" & 72" W	18"	60"	30"	\$1956	76	E
Credenza locks & b/f pedestals 	MCK6018		18"	60"	30"	\$3067	150	E

to order

1. Item Number
2. Pull Style
3. Paint Finish
4. Edge Finish
5. Leg Finish

example

MER4218C - FL - 5503 - 4072 - CH99

ITEM NUMBER PULL STYLE PAINT FINISH EDGE FINISH LEG FINISH

please separate each item with a dash

drawer pull options

MODEL	DESCRIPTION
RS	Recessed



leg finish options

FINISH	DESCRIPTION	PRICE
CH99	Chrome	Standard
Paint Finish #	Painted	10% Upcharge

Marathon Series

overstorage units and tackboards

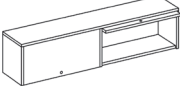
DESCRIPTION	ITEM #	NOTE	COM	D	W	H	PRICE	SHIP WT.	LEAD TIME*
Wall Mounted Overstorage Cabinet 	WM30	Includes mounting hardware		14"	30"	15 ½"	\$1058	56	E
	WM36	Includes mounting hardware		14"	36"	15 ½"	\$1087	61	E
	WM42	Includes mounting hardware		14"	42"	15 ½"	\$1100	66	E
	WM48	Includes mounting hardware		14"	48"	15 ½"	\$1113	70	E
	WM60	Includes mounting hardware		14"	60"	15 ½"	\$1632	89	E
	WM66**	Includes mounting hardware		14"	66"	15 ½"	\$2145	96	E
	WM72**	Includes mounting hardware		14"	72"	15 ½"	\$2174	103	E
Wall Mounted Tackboards for overstorage cabinet	SFT3019	Includes mounting hardware	2 YD	1"	30"	22 ½"	\$891	28	E
	SFT3619	Includes mounting hardware	2 YD	1"	36"	22 ½"	\$915	38	E
	SFT4219	Includes mounting hardware	2 YD	1"	42"	22 ½"	\$928	42	E
	SFT4819	Includes mounting hardware	2 YD	1"	48"	22 ½"	\$944	48	E
	SFT6019	Includes mounting hardware	2 YD	1"	60"	22 ½"	\$1032	68	E
	SFT6619	Includes mounting hardware	2 YD	1"	66"	22 ½"	\$1054	74	E
	SFT7219	Includes mounting hardware	2.5 YD	1"	72"	22 ½"	\$1091	80	E

to order

1. Item Number
2. Paint Finish
3. Fabric (for tackboards only)

example

SOS4219TB - 5503 -

ITEM NUMBER PAINT FINISH FABRIC/COM

please separate each item with a dash

**WM66 ships as (1) 30" w and (1) 36" w units

**WM72 ships as (2) 36" w units

Marathon Series

desking accessories

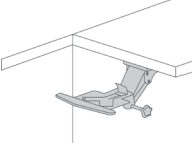
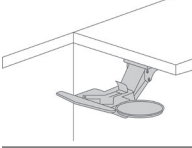
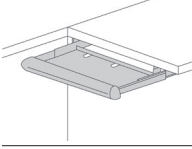
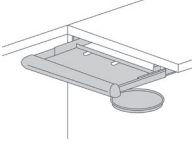
DESCRIPTION	ITEM #	NOTE	PRICE	SHIP WT.	LEAD TIME*
Keyboard Arm 	KB1	Swivels 360 degrees, tils w/ 6" height adjustments Includes wrist rest	\$471	10	S
Keyboard Arm w/ mouse pad 	KB2	Swivels 360 degrees, tils w/ 6" height adjustments Includes wrist rest & mouse pad, for use on left or right	\$532	12	S
Keyboard Tray 	KD1	Steel platform w/ cushion palm rest Steel ball bearing slides	\$697	9	S
Keyboard Tray w/ mouse pad 	KD2	Steel platform w/ cushion palm rest Steel ball bearing slides & mouse pad for use on left or right	\$405	10	S
24" W Task Light	MTL24		\$273	5.5	S
48" W Task Light	MTL48		\$301	7	S

to order

1. Item Number

example

KB1
ITEM NUMBER

Marathon Series

introduction - seating



General

Haskell's Marathon Series is proud to be U.S. Made in Grand Rapids, Michigan.

Our seating is designed with today's workplace in mind. Superior craftsmanship, outstanding comfort, and produced with the use of recycled materials for sustainability. Our chairs our constant but the people who use them come in all shapes and sizes, that's why our task seating comes with the following features:

- Quick ship available on all Marathon seating
- Fully height adjustable one touch pneumatic height adjustment
- Comfortable waterfall seat construction with contoured foam for all day use
- Adjustable lumbar support which allows the lumbar to hit just the right spot, with vertical and horizontal adjustment
- Adjustable seat depth to fit any size individual
- Marathon chairs have a weight capacity of 300 lbs.
- Durable easy-care fabrics that breath so your body breaths as well
- Marathon chairs swivel 360 degrees
- Durable scuff resistant 5 star base with dual hard wheel casters for strength and mobility
- Synchro Tilt Hardware with back lock and tension adjustable settings
- 24/7 Intensive use chair comes with 3.5" of high-density foam for comfort and durability Intensive use chair is produced for 24/7 use, is extra wide in seat width, has a 3.5" seat of high density foam for comfort and durability and has a weight capacity of 400 lbs., with upholstered seat and back with adjustable active lumbar support.
- Your choice of arms: Vertically adjustable arms with urethane arm pads for comfort and durability or Urethane Fixed Arms when adjustability is not needed
- Marathon Guest/Side chairs stack or next for easy storage
- Task chairs upholstered seats are produced with a molded foam seat with a waterfall edge

- When headrests are used, the headrest fabric will match the seat upholstery
- Task Stools has an adjustable foot ring for ultimate size flexibility
- Nesting Chair is produced with an upholstered seat and a strong flexible polypropylene back, powder coated frame
- All Marathon Series Seating meets ANSI/BIFMA X5.1

When you are making your seating choice you can sit assured that the Marathon Series will provide you with the features that will give you hours of productivity and comfort in the workplace. Comfort and strength is built into every chair. Our seats are over 18" wide and our high back, backs are over 24" high for lots of support. Our standard frame is black and our base is super strong, made of fiberglass reinforced Nylon. Mesh backs material is protected to prevent damage from hard surfaces/edges. Domestic polyurethane arm pads are available with soft long lasting material.

Haskell Environmental Statement

Haskell has provided federal agencies, schools and the contract furniture markets, with furniture that is known for its extra long life cycle. Our furniture is constructed from steel, the most widely recycled material in North America. These products are a key value for Haskell in serving the community, including acting responsibly. In this vein, Haskell has demonstrated an exceptional commitment to Environmental improvement. Haskell has always taken the common sense approach in designing both quality and durability into its products.

- Marathon seating is Green and meets ANSI/BIFMAX7.1 VOC emissions
- All metal components are painted with powder coat
- Marathon seating is produced with over 20% recycled material



Marathon Series

introduction - seating

Steel

Haskell's primary material is steel. Steel is the most recycled post-consumer material used in North America. More steel is recycled than all other metals, paper, glass and plastic combined. The use of recycled steel does not degrade any performance characteristics of steel.

Powder Coating

Haskell's products are designed around the newest steel coating technology. All steel parts and products are coated with powder that is cured in an oven. This offers superior durability and performance while eliminating waste and pollutants. Powder coating is in the enviable position of completely eliminating ozone layer eroding VOC (Volatile Organic Compounds).

Adhesives

In keeping with our powder coating that helps eliminate harmful VOC's. Haskell's Marathon seating incorporates the use of virtually VOC free adhesives when producing our seating product. We follow the stringent Ansi/Bifma M7.1 guidelines set for VOC adhesives. Every step in our process we are evaluating and using methods that eliminate our carbon footprint.

Packaging







Delivery of an undamaged unit on-site is a positive alternative to manufacturing a replacement in terms of energy and materials. For the last three years Haskell has consistently reduced the cardboard content of it's packaging by more than half while decreasing shipping damage. Corrugated cardboard used by Haskell contain at least 25% recycled materials.

...And More

Haskell's manufacturing process and facility is a 99% solvent-free environment and the company is as dedicated to the conservation of our natural resources as it is to the elimination of pollutants. All forklifts have been converted from gasoline to either natural gas or electric power, or have been replaced by electric scissor lifts and gravity fed roller tables.

Marathon Series

task chairs

DESCRIPTION	ITEM #	MESH BACK	UPHOLSTERED BACK	LEATHER	PRICE	LEAD TIME*
High Back Task Chair w/ Integrated Headrest (shown with mesh back and integrated headrest)	 SC333	✓	✓		\$1604	*
High Back Task Chair w/ Adjustable Headrest (shown with upholstered back and integrated headrest)	 SC355	✓	✓	✓	\$1648	*
Mid Back Task Chair (shown with upholstered back)	 SC210	✓	✓		\$1441	*
Mid Back Task Chair (shown with mesh back)	 SC220	✓	✓		\$1441	*
Mid Back Rotary Stool (shown with upholstered back)	 SC225	✓	✓		\$1679	*
24/7 Intensive Use (shown with upholstered back)	 SC247	✓	✓		\$2999	*
Ergonomic Task chair with Flexible back	SC400	✓	✓		\$2517	*

to order

1. Item Number
2. Back Style
3. Fabric Option
4. Arm Style (if applicable)
5. Additional Options (if applicable)

example

SC333 - UB - VN - ADO - BA
ITEM NUMBER BACK STYLE FABRIC OPTION ARM STYLE OPTIONS

please separate each item with a dash

back style

CODE	DESCRIPTION	PRICE
MB	Mesh Back	
UB	Upholstered Back	

fabric options

CODE	DESCRIPTION	PRICE
VN	All Vinyl Grades	\$36
UB3	Grade 2 Fabric	\$26
UB3	Grade 3 Fabric	\$48
LT	Leather	\$832
HCF	Healthcare Fabric	\$166

arm style

CODE	DESCRIPTION	PRICE
AD	Adjustable Arm	\$334
ADO	Fixed Arm	\$230
AD4	4 way adjustable arm	\$334
AD6	Adjustable up/down,in/out,front/back,pivot LFT/RT	\$322
AD7	Adjustable polished aluminum arm	\$334
FA	Fixed Arms (black poly or brushed aluminum)	\$302
FP	Full Panel Arm	\$208
UC	Upholstered Cap	\$84

additional options

CODE	DESCRIPTION	PRICE
AZ	Fully Assembled	\$218
BA	Brushed Aluminum Base	\$208
BAF	Brushed Aluminum Frame	\$1248
ST	Synchro Tilt	\$252
SS	Seat Slider	\$88
QS	Quick Ship	\$208
HWC	Hard Wheel Casters	\$130
SWC	Soft Wheel Casters	\$130
MPB	Plastic Base	\$146

* Please contact Customer Service for lead time.

Marathon Series

side chairs

DESCRIPTION	ITEM #	MESH BACK	POLYPROPYLENE BACK	UPHOLSTERED BACK	PRICE	LEAD TIME*
Guest Chair	SC100	✓	✓	✓	\$1115	*
Guest Chair with Casters	SC125	✓	✓	✓	\$1267	*
Guest Chair with Casters	SC150	✓	✓	✓	\$1267	*
Nesting Guest Chair with Casters	SC175	✓	✓	✓	\$1459	*

to order

1. Item Number
2. Back Style
3. Fabric Option

example

SC100 - UB - GR
ITEM NUMBER BACK STYLE FABRIC OPTION

please separate each item with a dash

back style

CODE	DESCRIPTION
MB	Mesh Back
PB	Polypropylene Back
UB	Upholstered Back

fabric options

GRADE 1		GRADE 2		GRADE 3		VINYL		LEATHER		MESH BACK	
CODE	DESCRIPTION	CODE	DESCRIPTION	CODE	DESCRIPTION	CODE	DESCRIPTION	CODE	DESCRIPTION	CODE	DESCRIPTION
AW	Alpine White	EB	Ebony	SK	Sky	AL	Ale	CV	Caviar	BK	Black
BO	Black Onyx	EC	Eclipse	LN	Lunar	BN	Black Satin	BL	Black	BE	Blue
BL	Cobalt Blue	EM	Ember	NG	Night	CA	Cabernet	CB	Coronet Blue	RD	Red
DY	Dark Gray	GL	Glint	FL	Fall	CD	Cordial	CH	Chinchilla	GY	Gray
FG	Forest Green	GP	Graphite	CH	Chile	CR	Cream	DG	Dark Gray		
GI	Graphite	LS	Laser	RB	Ruby	FE	Feather	DM	Demitasse		
GR	Gray	MD	Midnight	DB	Jazz	HA	Harness	IL	Illusion		
SB	Steel Blue	ML	Moonlight	SF	Surf	IC	Ice	TN	Tan		
TA	Tan	MT	Meteor			MI	Mist	WH	White		
RD	Red	SP	Spring			VL	Velvet				
		WV	Wave			TA	Tan				
						WI	White				
						GM	Dark Gray				

* Please contact Customer Service for lead time.

Marathon Series

guest chairs & sofas

DESCRIPTION	ITEM #	PRICE	LEAD TIME*
Armless Guest Chair	GS25	\$2226	*
Closed Arm Guest Chair	GS50	\$2598	*
Open Arm Guest Chair	GS75	\$2376	*
Lounge Chair	LC100	\$9649	*
Two Seat Sofa	LC222	\$14769	*
Three Seat Sofa	LC333	\$21523	*

to order

1. Item Number
2. Fabric Option
3. Arm Style (if applicable)

example **GS25 - VN - AD6**

ITEM NUMBER FABRIC OPTION ARM STYLE

please separate each item with a dash

fabric options

CODE	DESCRIPTION	PRICE
VN	All Vinyl Grades	\$36
UB2	Grade 2 Fabric	\$26
UB3	Grade 3 Fabric	\$48
LT	Leather	\$832
BA	Brushed Aluminum Base	\$208

arm style

CODE	DESCRIPTION	PRICE
AD6	ADJ up/down,in/out,front/back,pivot LFT, RT	\$322
FP	Full Panel Arm	\$208
UC	Upholstered Cap	\$84

* Please contact Customer Service for lead time.

Market Series

introduction - pedestals



General

All Market Pedestals are 15" in width. All file drawers are designed to accommodate hanging folders. Mobile units are standard with counterweights to reduce the likelihood of tipping. However, it is recommended that not more than one heavily loaded drawer be opened at one time. Caution should be exercised when pedestals are used as freestanding units.

Assembly

All units ship fully assembled.

Locks

Market Pedestals come standard with a removable core lock for easy reconfiguration on site. Units can be keyed alike to other Haskell Products upon request.

Unit Construction

The Market Series Pedestal and Lateral drawer fronts are external to the case and are referred to as Proud.

Wood Core Tops

Laminate tops are available as a separate component. Tops are available with a 3mm edge. All wood core tops are 1 1/8" thick.

Casters/Glides

Market Pedestals are available with either adjustable glides or casters. Casters and glides are easily interchangeable in the field.

COM

All COM yardage is based on a 54" wide fabric.

Keying Information and Locking Options

All locks feature a removable core which is easily removed on site. All lock cores are interchangeable through all products as cores are universal.

Locks throughout an order or locks within a particular workstation can be keyed alike at no additional charge if specified when ordering. Keyed Alike means that all locks are identical. To order, specify which products are to be keyed alike and order a "Removable Core Lock Kit" for each group of products to be keyed alike. The specified products will be shipped without lock cores. The cores for each workstation will be packaged separately. All Removable Core Lock Kits are shipped with a control key for removing or inserting lock cores. Note that a control key works only when a lock is in the unlocked position.

Master keys, which operate any removable core lock, are available for \$35 net each.

One control key is provided for each "key alike" order. If additional keys are needed, cost is \$35 net each.

Additional keys can be purchased for \$15 net per key.

Market Series

worksurface supporting and fixed pedestals w/ proud drawers

DESCRIPTION	ITEM #	D	W	H	PRICE	SHIP WT.	LEAD TIME*
Worksurface Supporting Pedestals file/file, open top	MK-WP18FF	18"	15"	27 5/8"	\$734	85	S
	MK-WP24FF	22"	15"	27 5/8"	\$744	85	S
	MK-WP28FF	28"	15"	27 5/8"	\$830	85	S
Worksurface Supporting Pedestals box/box/file, open top	MK-WP18BBF	18"	15"	27 5/8"	\$754	88	S
	MK-WP24BBF	22"	15"	27 5/8"	\$764	88	S
	MK-WP28BBF	28"	15"	27 5/8"	\$850	88	S
Fixed Pedestal file/file	MK-FP18FF	18"	15"	27 5/8"	\$760	87	S
	MK-FP24FF	22"	15"	27 5/8"	\$770	87	S
	MK-FP28FF	28"	15"	27 5/8"	\$856	87	S
Fixed Pedestal box/box/file	MK-FP18BBF	18"	15"	27 5/8"	\$780	83	S
	MK-FP24BBF	22"	15"	27 5/8"	\$790	83	S
	MK-FP28BBF	28"	15"	27 5/8"	\$876	83	S

to order	1. Item Number	example	MK-WP18FF - FL - 5503		
	2. Pull Style		ITEM NUMBER	PULL STYLE	PAINT FINISH
	3. Paint Finish		<i>please separate each item with a dash</i>		

drawer pull options

MODEL	DESCRIPTION
FL	Full

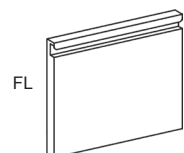

Market Series

mobile pedestals w/ proud drawers

DESCRIPTION	ITEM #	COM	D	W	H	PRICE	SHIP WT.	LEAD TIME*
Mobile Pedestal file/file	MK-MP18FF		18"	15"	27 ½"	\$860	83	S
	MK-MP24FF		22"	15"	27 ½"	\$890	83	S
	MK-MP28FF		28"	15"	27 ½"	\$990	83	S
Mobile Pedestal box/box/file	MK-MP18BBF		18"	15"	27 ½"	\$880	87	S
	MK-MP24BBF		22"	15"	27 ½"	\$910	87	S
	MK-MP28BBF		28"	15"	27 ½"	\$1010	87	S
Mobile Pedestal cushion top box/file	MK-ZFMP18BF	1 YD	18"	15"	24 ⅞"	\$964	80	S
	MK-ZFMP24BF	1 YD	22"	15"	24 ⅞"	\$988	80	S
	MK-ZFMP28BF	1 YD	28"	15"	24 ⅞"	\$1004	80	S
Mobile Pedestal metal top box/file	MK-ZMP18BF		18"	15"	22 ¾"	\$648	80	S
	MK-ZMP24BF		22"	15"	22 ¾"	\$670	80	S
	MK-ZMP28BF		28"	15"	22 ¾"	\$770	80	S

to order

1. Item Number
2. Pull Style
3. Paint Finish
4. Fabric (for cushion top pedestal only)

example

MK-MP18FF - FL - 5503 -

ITEM NUMBER PULL STYLE PAINT FINISH FABRIC

please separate each item with a dash

drawer pull options

MODEL DESCRIPTION

FL Full

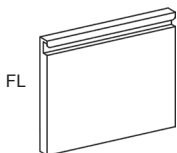

Market Series

introduction - lateral files & storage cabinets

General

Market Lateral Files and Overfile units are 18" deep. Adjustable glides are standard at the front and rear of all cases. Files are designed with safety interlock mechanisms integrated into the suspensions. All standard lateral files with fixed fronts drawers come with a set of hanging folder frames for side-to-side filing. Two dividers can be substituted for side-to-side rails at no charge if specified when ordering. Front-to-back filing bars may be ordered separately for field installation. All drawer fronts are field replaceable.

Suspensions

All Market Lateral Files have heavy duty, fully progressive steel ball bearing suspensions with integrated slide lock system. The integrated slide lock system has the interlock built into the drawer slide to enable a more positive interlock system.

Assembly

All units ship fully assembled. Interior drawer accessories are field-installed only.

Locks

Market Laterals come standard with a removable core lock for easy reconfiguration on site. Units can be keyed alike to other Haskell Products upon request.

Wood Core Tops

Laminate tops are available as a separate component to span multiple files. Tops are available with a 3mm edge. All wood core tops are 1 1/8" thick.

Unit Construction

The Market Series Pedestal and Lateral drawer fronts are external to the case and are referred to as Proud.

Keying Information and Locking Options

All locks feature a removable core which is easily removed on site. All lock cores are interchangeable through all products as cores are universal.

Locks throughout an order or locks within a particular workstation can be keyed alike at no additional charge if specified when ordering. "Keyed Alike" means that all locks are identical. To order, specify which products are to be keyed alike and order a "Removable Core Lock Kit" for each group of products to be keyed alike. The specified products will be shipped without lock cores. The cores for each workstation will be packaged separately. All Removable Core Lock Kits are shipped with a control key for removing or inserting lock cores. Note that a control key works only when a lock is in the unlocked position.

Master keys, which operate any removable core lock, are available for \$35 net each.

One control key is provided for each "key alike" order. If additional keys are needed, cost is \$35 net each.

Additional keys can be purchased for \$15 net per key.

Market Series

lateral files w/ 12" proud drawers

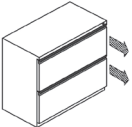
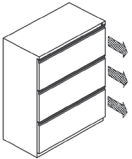
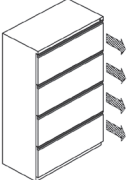
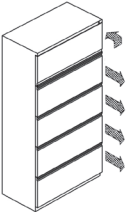
DESCRIPTION	ITEM #	NOTE	D	W	H	PRICE	SHIP WT.	LEAD TIME*
Two High (2) 12" proud drawers 	MK-LA12P-3024-2D		18"	30"	27 ½"	\$1336	103	S
	MK-LA12P-3624-2D		18"	36"	27 ½"	\$1414	119	S
	MK-LA12P-4224-2D		18"	42"	27 ½"	\$1492	134	S
Three High (3) 12" proud drawers 	MK-LA12P-3036-3D		18"	30"	39 ½"	\$1798	143	S
	MK-LA12P-3636-3D		18"	36"	39 ½"	\$1892	162	S
	MK-LA12P-4236-3D		18"	42"	39 ½"	\$1974	181	S
Four High (4) 12" proud drawers 	MK-LA12P-3048-4D		18"	30"W	51 ½"	\$2176	182	S
	MK-LA12P-3648-4D		18"	36"W	51 ½"	\$2388	205	S
	MK-LA12P-4248-4D		18"	42"W	51 ½"	\$2498	227	S
Five High (4) 12" proud drawers & (1) 12" flipper door w/ fixed shelf 	MK-LA12P-3060-4D1R	Top drawer rests on top of unit	18"	30"	67 ¾"	\$2680	221	S
	MK-LA12P-3660-4D1R	Top drawer rests on top of unit	18"	36"	67 ¾"	\$2948	248	S
	MK-LA12P-4260-4D1R	Top drawer rests on top of unit	18"	42"	67 ¾"	\$3064	274	S

to order

1. Item Number
2. Pull Style
3. Paint Finish

example

MK-LA12P-3024-2D - FL - 5503

ITEM NUMBER PULL STYLE PAINT FINISH

please separate each item with a dash

drawer pull options

MODEL DESCRIPTION

FL Full

FL

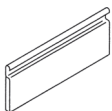

Market Series

lateral pedestals w/ proud drawers

DESCRIPTION	ITEM #	NOTE	D	W	H	PRICE	SHIP WT.	LEAD TIME*
Filing Center Pedestal-right combo-unit bottom drawer equipped w/ side-to-side hanging bars, open top	MK-LS12-3024R-2Y	Unit fits under worksurface	18"	30"	27 ½"	\$2040	90	S
Filing Center Pedestal-left combo-unit bottom drawer equipped w/ side-to-side hanging bars, open top	MK-LS12-3024L-2Y	Unit fits under worksurface	18"	30"	27 ½"	\$2040	90	S
Lateral File Pedestal file/file, drawers equipped w/ side-to-side hanging bars, open top	MK-LS12-3024-2D	Unit fits under worksurface	18"	30"	27 ½"	\$1386	103	S
	MK-LS12-3624-2D	Unit fits under worksurface	18"	36"	27 ½"	\$1448	119	S
	MK-LS12-4224-2D	Unit fits under worksurface	18"	42"	27 ½"	\$1458	134	S

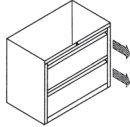
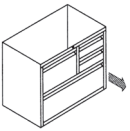
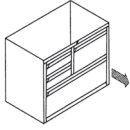

to order	1. Item Number	MK-LS12-3024R-2Y			-	FL	-	5503
	2. Pull Style	ITEM NUMBER				PULL STYLE		PAINT FINISH
	3. Paint Finish	please separate each item with a dash						

drawer pull options

MODEL DESCRIPTION

FL Full

FL

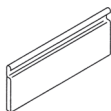

Market Series

wardrobe cabinets

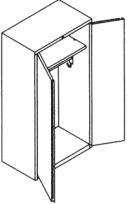
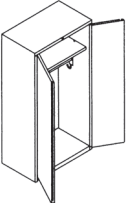
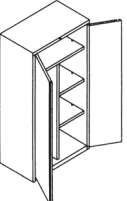
DESCRIPTION	ITEM #	D	W	H	PRICE	SHIP WT.	LEAD TIME*
Wardrobe Unit, 18" D (1) fixed shelf, coat hanger, (2) hooks 	MK-CW12-3048-FL	18"	30"	51 1/2"	\$1790	110	S
	MK-CW12-3060-FL	18"	30"	67 3/8"	\$2102	125	S
	MK-CW12-3648-FL	18"	36"	51 1/2"	\$1924	120	S
	MK-CW12-3660-FL	18"	36"	67 3/8"	\$2138	135	S
	MK-CW12-4248-FL	18"	42"	51 1/2"	\$2268	138	S
	MK-CW12-4260-FL	18"	42"	67 3/8"	\$2468	153	S
Wardrobe Unit, 24" D (1) fixed shelf, coat hanger, (2) hooks 	MK-CW12-304824-FL	24"	30"	51 1/2"	\$2258	132	S
	MK-CW12-306024-FL	24"	30"	67 3/8"	\$2452	148	S
	MK-CW12-364824-FL	24"	36"	51 1/2"	\$2478	144	S
	MK-CW12-366024-FL	24"	36"	67 3/8"	\$2488	159	S
	MK-CW12-424824-FL	24"	42"	51 1/2"	\$2636	162	S
	MK-CW12-426024-FL	24"	42"	67 3/8"	\$2688	178	S
Wardrobe/Storage Unit, 18" D (2) adjustable shelves, coat hanger, (1) hook 	MK-CC12-3048-FL	18"	30"	51 1/2"	\$2268	118	S
	MK-CC12-3060-FL	18"	30"	67 3/8"	\$2558	133	S
	MK-CC12-3648-FL	18"	36"	51 1/2"	\$2288	134	S
	MK-CC12-3660-FL	18"	36"	67 3/8"	\$2588	150	S
	MK-CC12-4248-FL	18"	42"	51 1/2"	\$2798	162	S
	MK-CC12-4260-FL	18"	42"	67 3/8"	\$2878	174	S

to order

1. Item Number
2. Paint Finish

example

MK-CW12-3648-FL - 5503

ITEM NUMBER PAINT FINISH

please separate each item with a dash

drawer pull

MODEL DESCRIPTION

FL Full

FL



Market Series

combination cabinets w/ proud drawers

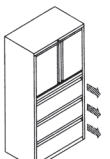
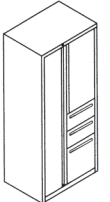
DESCRIPTION	ITEM #	D	W	H	PRICE	SHIP WT.	LEAD TIME*
Lateral/Storage Unit (2) 12" drawers (1) 36" storage cabinet (1) adjustable shelf	MK-FC12-3660-2D-FL	18"	36"	67 ¾"	\$3024	205	S
							
Lateral/Storage Unit (3) 12" drawers (1) 24" storage cabinet (1) adjustable shelf	MK-FC12-3660-3D-FL	18"	36"	67 ¾"	\$3162	248	S
							
Personal Storage Tower (1) full height wardrobe (1) Box/Box/File pedestal (1) 36" storage cabinet	MK-TW12-242365-BBF	23"	24"	63 ½"	\$2988	265	S
							

to order	1. Item Number	MK-FC12-3660-2D-FL	-	5503
	2. Paint Finish			
		ITEM NUMBER		PAINT FINISH

example please separate each item with a dash

drawer pull

MODEL	DESCRIPTION
FL	Full

FL 

Market Series

storage cabinets

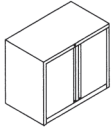
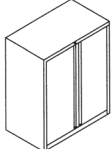
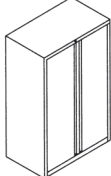
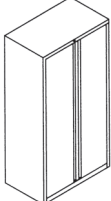
DESCRIPTION	ITEM #	D	W	H	PRICE	SHIP WT.	LEAD TIME*
Storage Cabinet, 27 ½" H (1) adjustable shelf 	MK-CA12-3024-1A-FL	18"	30"	27 ½"	\$1224	72	S
	MK-CA12-3624-1A-FL	18"	36"	27 ½"	\$1266	75	S
	MK-CA12-4224-1A-FL	18"	42"	27 ½"	\$1366	80	S
	MK-CA12-302424-1A-FL	24"	30"	27 ½"	\$1632	83	S
	MK-CA12-362424-1A-FL	24"	36"	27 ½"	\$1688	85	S
	MK-CA12-422424-1A-FL	24"	42"	27 ½"	\$1824	88	S
Storage Cabinet, 39 ½" H (2) adjustable shelves 	MK-CA12-3036-2A-FL	18"	30"	39 ½"	\$1468	91	S
	MK-CA12-3636-2A-FL	18"	36"	39 ½"	\$1538	100	S
	MK-CA12-4236-2A-FL	18"	42"	39 ½"	\$1670	105	S
	MK-CA12-302436-2A-FL	24"	30"	39 ½"	\$2190	104	S
	MK-CA12-362436-2A-FL	24"	36"	39 ½"	\$2294	111	S
	MK-CA12-422436-2A-FL	24"	42"	39 ½"	\$2490	118	S
Storage Cabinet, 51 ½" H (3) adjustable shelves 	MK-CA12-3048-3A-FL	18"	30"	51 ½"	\$1768	118	S
	MK-CA12-3648-3A-FL	18"	36"	51 ½"	\$1876	125	S
	MK-CA12-4248-3A-FL	18"	42"	51 ½"	\$2090	133	S
	MK-CA12-302448-3A-FL	24"	30"	51 ½"	\$2358	130	S
	MK-CA12-362448-3A-FL	24"	36"	51 ½"	\$2500	138	S
	MK-CA12-422448-3A-FL	24"	42"	51 ½"	\$2784	144	S
Storage Cabinet, 67 ¾" H (3) adjustable shelves 	MK-CA12-3060-3A-FL	18"	30"	67 ¾"	\$2140	139	S
	MK-CA12-3660-3A-FL	18"	36"	67 ¾"	\$2282	150	S
	MK-CA12-4260-3A-FL	18"	42"	67 ¾"	\$2496	155	S
	MK-CA12-302460-3A-FL	24"	30"	67 ¾"	\$2850	159	S
	MK-CA12-362460-3A-FL	24"	36"	67 ¾"	\$3040	164	S
	MK-CA12-422460-3A-FL	24"	42"	67 ¾"	\$3328	171	S

to order

1. Item Number
2. Paint Finish

example

MK-CA12-3624-1A-FL - 5503

ITEM NUMBER

PAINT FINISH

please separate each item with a dash

drawer pull

MODEL DESCRIPTION



FL Full

FL

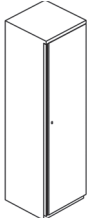

Market Series

storage cabinets

DESCRIPTION	ITEM #	NOTE	D	W	H	PRICE	SHIP WT.	LEAD TIME*
Single Door Storage Cabinet	MK-SC18R-1864-FL	Door opens to the right	24"	18"	67 3/4"	\$1690	84	S
								
Single Door Storage Cabinet	MK-SC18L-1864-FL	Door opens to the left	24"	18"	67 3/4"	\$1690	84	S
								
Hanger Bar	MK-SC18-HB	For 18" W cabinet				\$130	4	S
Shelf	MK-SC18-SSH	For 18" W cabinet				\$130	4	S

to order	1. Item Number	example	MK-SC18R-1864-FL	-	5503
	2. Paint Finish		ITEM NUMBER	PAINT FINISH	
			<i>please separate each item with a dash</i>		

drawer pull

MODEL DESCRIPTION

FL Full

FL



Market Series

overfiles cabinets

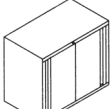
DESCRIPTION	ITEM #	NOTE	D	W	H	PRICE	SHIP WT.	LEAD TIME*
Overfile Cabinet, 27 ½" H hinged doors 	MK-OA12-3025-FL-H	When used in conjunction w/ 3-12" lateral the height will line up w/ a 5-12" lateral case	18"	30"	27 ½"	\$1016	78	S
	MK-OA12-3625-FL-H	When used in conjunction w/ 3-12" lateral the height will line up w/ a 5-12" lateral case	18"	36"	27 ½"	\$1194	89	S
	MK-OA12-4225-FL-H	When used in conjunction w/ 3-12" lateral the height will line up w/ a 5-12" lateral case	18"	42"	27 ½"	\$1440	89	S

to order

1. Item Number
2. Paint Finish

example

MK-OA12-3015-FL-H - 5503

ITEM NUMBER

PAINT FINISH

please separate each item with a dash

drawer pull

MODEL DESCRIPTION

FL Full

FL

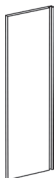

Market Series

lateral files laminate tops

DESCRIPTION	ITEM NUMBER	NOTE	D	W	3MM EDGE	SHIP WT.	LEAD TIME*
Laminate Tops	HKLFT1830	For (1) 30" W lateral file	18"	30"	\$208	18	S
	HKLFT1836	For (1) 36" W lateral file	18"	36"	\$240	20	S
	HKLFT1842	For (1) 42" W lateral file	18"	42"	\$270	25	S
	HKLFT1860	For (2) 30" W lateral files	18"	60"	\$340	35	S
	HKLFT1872	For (2) 36" W lateral files	18"	72"	\$410	42	S
	HKLFT1884	For (2) 42" W lateral files	18"	84"	\$470	49	S

to order

1. Item Number
2. Laminate
3. Edge Finish

example

HKLFT1830 - HS - 4072
ITEM NUMBER LAMINATE EDGE FINISH
please separate each item with a dash

Market Series

lateral files accessories

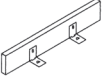
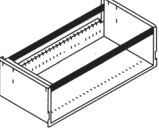
DESCRIPTION	ITEM #	NOTE	PRICE	SHIP WT.	LEAD TIME*
Counter Weight 	CWF	For use with any size lateral file	\$248	20	S
Proud Hanging Bars front-to-back	FBS/18-2-P	Sold as set, one set required per drawer. For use in any size lateral file	\$88	1	S
Proud Hanging Bars side-to-side 	SSS-30-P	For 30" W drawers	\$88	1	S
	SSS-36-P	For 36" W drawers	\$88	1	S
	SSS-42-P	For 42" W drawers	\$88	1	S

to order

1. Item Number

example

CWF
ITEM NUMBER

Market Series

introduction - vertical files



Vertical files shown with recessed pulls. Full pulls only are available.

General

Market Vertical Files are 28" in exterior depth with an interior filing capacity of 26". Market Vertical Files come standard with the safety interlock system integrated within each slide, allowing only one drawer to open at a time. All vertical files are available in 15" (letter) width. Adjustable glides are standard at the front and rear of all cases and all files drawers have been designed to accommodate hanging folders.

Suspensions:

All Market Vertical Files have heavy duty, fully progressive steel ball bearing suspensions with integrated slide lock system.

Assembly

All units ship fully assembled. Interior drawer accessories are field-installed only.

Locks

Market Vertical Files come standard with a removable core lock for easy reconfiguration on site. Units can be keyed alike to other Haskell Products upon request.

Unit Construction

The Market Series Pedestal and Vertical drawer fronts are external to the case and are referred to as Proud.

Wood Core Tops

Laminate tops are available as a separate component to span one to four files. Tops are available with a 3mm edge. All wood core tops are 1 1/8" thick.

Keying Information and Locking Options

All locks feature a removable core which is easily removed on site. All lock cores are interchangeable through all products as cores are universal.

Locks throughout an order or locks within a particular workstation can be keyed alike at no additional charge if specified when ordering. Keyed Alike means that all locks are identical. To order, specify which products are to be keyed alike and order a "Removable Core Lock Kit" for each group of products to be keyed alike. The specified products will be shipped without lock cores. The cores for each workstation will be packaged separately. All Removable Core Lock Kits are shipped with a control key for removing or inserting lock cores. Note that a control key works only when a lock is in the unlocked position.



Master keys, which operate any removable core lock, are available for \$35 net each.

One control key is provided for each "key alike" order. If additional keys are needed, cost is \$35 net each.

Additional keys can be purchased for \$15 net per key.

Market Series

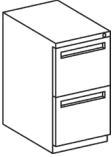
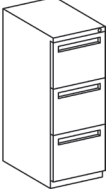
letter width vertical file w/ proud drawers

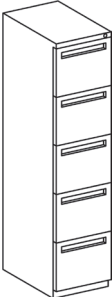
DESCRIPTION	ITEM #	D	W	H	PRICE	SHIP WT.	LEAD TIME*
Letter Two High 	MK-HVFR2	28"	15"	27½"	\$925	72	S
Letter Three High 	MK-HVFR3	28"	15"	39½"	\$1320	98	S
Letter Four High 	MK-HVFR4	28"	15"	51½"	\$1514	125	S
Letter Five High 	MK-HVFR5	28"	15"	63½"	\$2064	148	S

to order

1. Item Number
2. Pull Style
3. Paint Finish

example

MK-HVFR2 - FL - 5503
ITEM NUMBER PULL STYLE PAINT FINISH
please separate each item with a dash

drawer pull options

MODEL	DESCRIPTION
FL	Full

FL

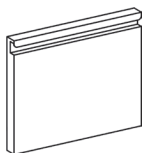

Market Series

vertical files laminate tops

DESCRIPTION	ITEM NUMBER	NOTE	D	W	3MM EDGE	SHIP WT.	LEAD TIME*
Laminate Tops for letter width files	HKVF1428	For (1) letter width file	28"	15"	\$218	12	S
	HKVF2928	For (2) letter width files	28"	30"	\$304	22	S
	HKVF4328	For (3) letter width files	28"	45 7/8"	\$378	32	S
	HKVF5828	For (4) letter width files	28"	60"	\$448	42	S

- to order
1. Item Number
 2. Laminate
 3. Edge Finish

example **HKVF1428 - HS - 4072**
ITEM NUMBER LAMINATE EDGE FINISH
please separate each item with a dash

* S – Standard Lead Time 4-6 weeks | E – Extended Lead Time 10-12 weeks | Lead times subject to change without notice

Market Series

introduction - bookcases



General

All Market Bookcases are 14" in exterior depth and are available in three standard widths 30", 36" and 42". Market Bookcases have 4 height options 27 ½", 39 ½", 51 ½" and 67 ½". Adjustable glides are standard at the front and rear of all cases.

Shelf Configuration

All Market Bookcases have (1) fixed bottom shelf.

- 27 ½" high bookcases have (1) adjustable shelf.
- 39 ½" high bookcases have (2) adjustable shelves.
- 51 ½" high bookcases have (3) adjustable shelves.
- 67 ½" high bookcases have (4) adjustable shelves.

Each Adjustable shelf includes 4 clips to position the shelf at customer's preference. Additional shelves are available.

Assembly

All units ship fully assembled.

Installation

Correct installation should include proper leveling and ganging of multiple units.

Wood Core Tops

Laminate tops are available as a separate component. Tops are available with a 3mm edge. All wood core tops are 1 ¼" thick.

Market Series

bookcases

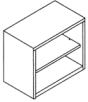
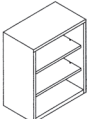
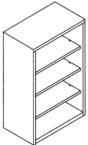
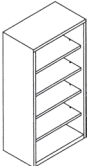
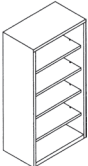
DESCRIPTION	ITEM #	NOTE	D	W	H	PRICE	SHIP WT.	LEAD TIME*
Bookcase, 27 ½"H (1) adjustable shelf 	MK-BC215-30		14"	30"	27 ½"	\$748	40	S
	MK-BC215-36		14"	36"	27 ½"	\$768	46	S
	MK-BC215-42		14"	42"	27 ½"	\$818	52	S
Bookcase, 39 ½"H (2) adjustable shelves 	MK-BC315-30		14"	30"	39 ½"	\$868	58	S
	MK-BC315-36		14"	36"	39 ½"	\$906	64	S
	MK-BC315-42		14"	42"	39 ½"	\$948	70	S
Bookcase, 51 ½"H (3) adjustable shelves 	MK-BC415-30		14"	30"	51 ½"	\$1062	72	S
	MK-BC415-36		14"	36"	51 ½"	\$1110	78	S
	MK-BC415-42		14"	42"	51 ½"	\$1156	84	S
Bookcase, 68"H (4) adjustable shelves 	MK-BC515-30		14"	30"	68"	\$1224	82	S
	MK-BC515-36		14"	36"	68"	\$1272	88	S
	MK-BC515-42		14"	42"	68"	\$1318	94	S
Adjustable Shelves (4) clips 	MK-HFBC3015SH	For 30" W bookcase	14"	30"		\$162	5	
	MK-HFBC3615SH	For 36" W bookcase	14"	36"		\$168	5	
	MK-HFBC4215SH	For 42" W bookcase	14"	42"		\$178	5	

to order

1. Item Number
2. Paint Finish

example

MK-BC215-30 - 5503

ITEM NUMBER PAINT FINISH

please separate each item with a dash

Market Series

bookcases laminate tops

DESCRIPTION	ITEM NUMBER	NOTE	D	W	3MM EDGE	SHIP WT.	LEAD TIME*
Laminate Tops for bookcases	HKBCT1430	For 30" W bookcase	14"	30"	\$276	20	S
	HKBCT1436	For 36" W bookcase	14"	36"	\$304	24	S
	HKBCT1442	For 42" W bookcase	14"	42"	\$338	28	S

to order

1. Item Number
2. Laminate
3. Edge Finish

example

HKBCT1430 - HS - 4072
ITEM NUMBER LAMINATE EDGE FINISH

please separate each item with a dash

Market Series

introduction - desking



General

All Market Desking Units are 28 ¾" H. All worksurfaces are laminate wood core tops at 1 ¾" thick and are available with a 3mm edge. Pedestals lock individually.

Locks

Market Desks come standard with a removable core lock for easy reconfiguration on site. Units can be keyed alike to other Haskell products upon request.

Installation

Correct installation should include proper leveling.

Application Considerations

When specifying the units for workstation configurations, note the following points:

*24" D returns are used for the 66" x 30" or wider single pedestal desks.

COM

All COM yardage is based on a 54" wide fabric.

Keying Information and Locking Options

All locks feature a removable core which is easily removed on site. All lock cores are interchangeable through all products as cores are universal.

Locks throughout an order or locks within a particular workstation can be keyed alike at no additional charge if specified when ordering. Keyed Alike means that all locks are identical. To order, specify which products are to be keyed alike and order a "Removable Core Lock Kit" for each group of products to be keyed alike. The specified products will be shipped without lock cores. The cores for each workstation will be packaged separately. All Removable Core Lock Kits are shipped with a control key for removing or inserting lock cores. Note that a control key works only when a lock is in the unlocked position.



Master keys, which operate any removable core, lock are available for \$35 net each.

One control key is provided for each "key alike" order. If additional keys are needed, cost is \$35 net each.

Additional keys can be purchased for \$15 net per key.

Market Series

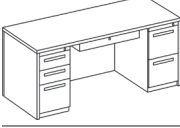
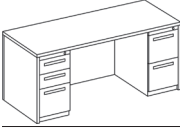
double pedestal desks

DESCRIPTION	ITEM #	D	W	H	3MM EDGE	SHIP WT.	LEAD TIME*
Double Pedestal Desk full height, 28 3/4" D pedestals, locks & center drawer 	MK-SDC6030FP-BBF-FF	30"	60"	28 3/4"	\$2794	236	S
	MK-SDC6630FP-BBF-FF	30"	66"	28 3/4"	\$2830	253	S
	MK-SDC7230FP-BBF-FF	30"	72"	28 3/4"	\$2944	265	S
Double Pedestal Desk full height, 28 3/4" D pedestals & locks 	MK-SD6030FP-BBF-FF	30"	60"	28 3/4"	\$2514	236	S
	MK-SD6630FP-BBF-FF	30"	66"	28 3/4"	\$2564	253	S
	MK-SD7230FP-BBF-FF	30"	72"	28 3/4"	\$2680	265	S
Double Pedestal Desk full height, 28 3/4" D pedestals, end panels & locks 	MK-SD6030EP-BBF-FF-24	30"	60"	28 3/4"	\$3068	231	S
	MK-SD6630EP-BBF-FF-24	30"	66"	28 3/4"	\$3088	251	S
	MK-SD7230EP-BBF-FF-24	30"	72"	28 3/4"	\$3264	263	S

to order

1. Item Number
2. Pull Style
3. Paint Finish
4. Laminate
5. Edge Finish

example

MK-SDC6030FP-BBF-FF - 5503 - HS - 4072

ITEM NUMBER PAINT FINISH LAMINATE EDGE FINISH

please separate each item with a dash

drawer pull options

MODEL DESCRIPTION

FL Full

FL

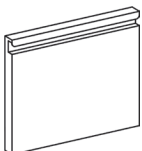

Market Series

bow front double pedestal desks

DESCRIPTION	ITEM #	D	W	H	3MM EDGE	SHIP WT.	LEAD TIME*
Bow Front Double Pedestal Desk	MK-SDC6648FP-BOW	48"	66"	28 ¾"	\$3264	273	S
full height, 28 ¾" D pedestals, locks & center drawer	MK-SDC7248FP-BOW	48"	72"	28 ¾"	\$3564	285	S
Bow Front Double Pedestal Desk	MK-SD6648FP-BOW	48"	66"	28 ¾"	\$3000	273	S
full height, 28 ¾" D pedestals & locks	MK-SD7248FP-BOW	48"	72"	28 ¾"	\$3300	285	S



to order

1. Item Number
2. Pull Style
3. Paint Finish
4. Laminate
5. Edge Finish
6. Options

example

MK-SDC6648FP-BOW - FL - 5503 - HS - 4072 - CL

ITEM NUMBER PULL STYLE PAINT FINISH LAMINATE EDGE FINISH OPTIONS

please separate each item with a dash

drawer pull options

MODEL	DESCRIPTION
FL	Full

central locking options

MODEL	DESCRIPTION	PRICE
CL	Central locking is available on desks 66" in width or less	\$84

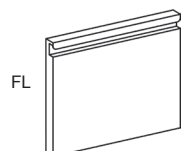

Market Series

single pedestal desks - right

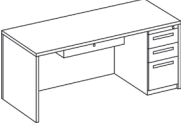
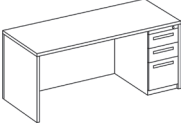
DESCRIPTION	ITEM #	D	W	H	3MM EDGE	SHIP WT.	LEAD TIME*
Single Right Pedestal Desk full height b/b/f pedestal, locks & center drawer 	MK-SSC6024FP-18-BBF	24"	60"	28 3/4"	\$2258	175	S
	MK-SSC6624FP-18-BBF	24"	66"	28 3/4"	\$2298	180	S
	MK-SSC7224FP-18-BBF	24"	72"	28 3/4"	\$2388	195	S
	MK-SSC4830FP-18-BBF	30"	48"	28 3/4"	\$2150	175	S
	MK-SSC6030FP-18-BBF	30"	60"	28 3/4"	\$2344	185	S
	MK-SSC6630FP-18-BBF	30"	66"	28 3/4"	\$2398	210	S
	MK-SSC7230FP-18-BBF	30"	72"	28 3/4"	\$2514	235	S
	MK-SSC7236FP-18-BBF	36"	72"	28 3/4"	\$2564	240	S
Single Right Pedestal Desk full height b/b/f pedestal & locks 	MK-SS6024FP-18-BBF	24"	60"	28 3/4"	\$1984	170	S
	MK-SS6624FP-18-BBF	24"	66"	28 3/4"	\$2020	175	S
	MK-SS7224FP-18-BBF	24"	72"	28 3/4"	\$2110	190	S
	MK-SS4830FP-18-BBF	30"	48"	28 3/4"	\$1904	170	S
	MK-SS6030FP-18-BBF	30"	60"	28 3/4"	\$2040	180	S
	MK-SS6630FP-18-BBF	30"	66"	28 3/4"	\$2064	205	S
	MK-SS7230FP-18-BBF	30"	72"	28 3/4"	\$2148	220	S
	MK-SS7236FP-18-BBF	36"	72"	28 3/4"	\$2174	235	S

to order

1. Item Number
2. Pull Style
3. Paint Finish
4. Laminate
5. Edge Finish

example

MK-SSC6024FP-18-BBF - FL - 5503 - HS - 4072

ITEM NUMBER PULL STYLE PAINT FINISH LAMINATE EDGE FINISH

please separate each item with a dash

drawer pull options

MODEL	DESCRIPTION
FL	Full

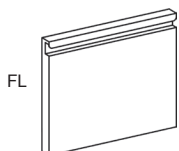



specification note

Haskell offers 22 1/4" depth pedestals on 24" depth desks.
 Haskell offers 28 3/4" depth pedestals on 30" & 36" depth desks.

Market Series

single pedestal desks - left

DESCRIPTION	ITEM #	D	W	H	3MM EDGE	SHIP WT.	LEAD TIME*
Single Left Pedestal Desk full height b/b/f pedestal, locks & center drawer 	MK-SSC6024FP-12-BBF	24"	60"	28 3/4"	\$2258	175	S
	MK-SSC6624FP-12-BBF	24"	66"	28 3/4"	\$2298	180	S
	MK-SSC7224FP-12-BBF	24"	72"	28 3/4"	\$2388	195	S
	MK-SSC4830FP-12-BBF	30"	48"	28 3/4"	\$2150	175	S
	MK-SSC6030FP-12-BBF	30"	60"	28 3/4"	\$2344	185	S
	MK-SSC6630FP-12-BBF	30"	66"	28 3/4"	\$2398	210	S
	MK-SSC7230FP-12-BBF	30"	72"	28 3/4"	\$2514	235	S
	MK-SSC7236FP-12-BBF	36"	72"	28 3/4"	\$2564	240	S
Single Left Pedestal Desk full height b/b/f pedestal & locks 	MK-SS6024FP-12-BBF	24"	60"	28 3/4"	\$1984	170	S
	MK-SS6624FP-12-BBF	24"	66"	28 3/4"	\$2020	175	S
	MK-SS7224FP-12-BBF	24"	72"	28 3/4"	\$2110	190	S
	MK-SS4830FP-12-BBF	30"	48"	28 3/4"	\$1904	170	S
	MK-SS6030FP-12-BBF	30"	60"	28 3/4"	\$2014	180	S
	MK-SS6630FP-12-BBF	30"	66"	28 3/4"	\$2064	205	S
	MK-SS7230FP-12-BBF	30"	72"	28 3/4"	\$2148	220	S
	MK-SS7236FP-12-BBF	36"	72"	28 3/4"	\$2174	235	S

to order

1. Item Number
2. Pull Style
3. Paint Finish
4. Laminate
5. Edge Finish

example

MK-SSC6024FP-12-BBF - FL - 5503 - HS - 4072
ITEM NUMBER PULL STYLE PAINT FINISH LAMINATE EDGE FINISH
please separate each item with a dash

drawer pull options

MODEL	DESCRIPTION
FL	Full

FL

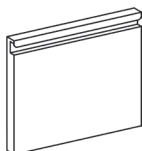

specification note

Haskell offers 22 1/4" depth pedestals on 24" depth desks.
 Haskell offers 28 3/4" depth pedestals on 30" & 36" depth desks.

Market Series

desk & return shells

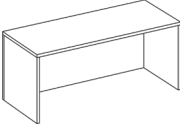
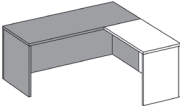
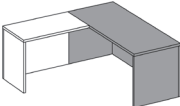
DESCRIPTION	ITEM #	D	W	H	3MM EDGE	SHIP WT.	LEAD TIME*
Desk Shell accommodates right or left return 	MK-DS4824	24"	48"	28 3/4"	\$1294	107	S
	MK-DS6024	24"	60"	28 3/4"	\$1404	121	S
	MK-DS6624	24"	66"	28 3/4"	\$1434	129	S
	MK-DS7224	24"	72"	28 3/4"	\$1464	149	S
	MK-DS4830	30"	48"	28 3/4"	\$1358	118	S
	MK-DS6030	30"	60"	28 3/4"	\$1538	133	S
	MK-DS6630	30"	66"	28 3/4"	\$1574	144	S
	MK-DS7230	30"	72"	28 3/4"	\$1634	154	S
	MK-DS7236	36"	72"	28 3/4"	\$1658	165	S
Return Shell - right 	MK-SR3618-18	18"	36"	28 3/4"	\$884	58	S
	MK-SR4218-18	18"	42"	28 3/4"	\$904	64	S
	MK-SR4818-18	18"	48"	28 3/4"	\$924	68	S
	MK-SR6018-18	18"	60"	28 3/4"	\$944	78	S
	MK-SR3624-18	24"	36"	28 3/4"	\$958	71	S
	MK-SR4224-18	24"	42"	28 3/4"	\$974	71	S
	MK-SR4824-18	24"	48"	28 3/4"	\$998	77	S
	MK-SR6024-18	24"	60"	28 3/4"	\$1054	88	S
Return Shell - left 	MK-SR3618-12	18"	36"	28 3/4"	\$884	58	S
	MK-SR4218-12	18"	42"	28 3/4"	\$904	64	S
	MK-SR4818-12	18"	48"	28 3/4"	\$924	68	S
	MK-SR6018-12	18"	60"	28 3/4"	\$944	78	S
	MK-SR3624-12	24"	36"	28 3/4"	\$958	71	S
	MK-SR4224-12	24"	42"	28 3/4"	\$974	71	S
	MK-SR4824-12	24"	48"	28 3/4"	\$998	77	S
	MK-SR6024-12	24"	60"	28 3/4"	\$1054	88	S

to order

1. Item Number
2. Pull Style
3. Paint Finish
4. Laminate
5. Edge Finish

example

MK-DS4824 - FL - 5503 - HS - 4072

ITEM NUMBER PULL STYLE PAINT FINISH LAMINATE EDGE FINISH

please separate each item with a dash

drawer pull options

MODEL DESCRIPTION

FL Full

FL

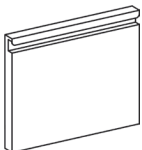

Market Series

pedestal returns

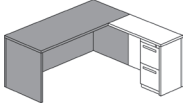
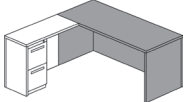
DESCRIPTION	ITEM #	D	W	H	3MM EDGE	SHIP WT.	LEAD TIME*
Right Pedestal Return full height, 22¼" D f/f pedestal 	MK-SPR3624FP-18-FF	24"	36"	28 ¾"	\$1350	120	S
	MK-SPR4224FP-18-FF	24"	42"	28 ¾"	\$1358	126	S
	MK-SPR4824FP-18-FF	24"	48"	28 ¾"	\$1448	132	S
	MK-SPR6024FP-18-FF	24"	60"	28 ¾"	\$1520	140	S
Left Pedestal Return full height, 22¼" D f/f pedestal 	MK-SPR3624FP-12-FF	24"	36"	28 ¾"	\$1350	120	S
	MK-SPR4224FP-12-FF	24"	42"	28 ¾"	\$1350	126	S
	MK-SPR4824FP-12-FF	24"	48"	28 ¾"	\$1448	132	S
	MK-SPR6024FP-12-FF	24"	60"	28 ¾"	\$1520	140	S

to order

1. Item Number
2. Pull Style
3. Paint Finish
4. Laminate
5. Edge Finish

example

MK-SPR3624FP-18-FF - FL - 5503 - HS - 4072

ITEM NUMBER PULL STYLE PAINT FINISH LAMINATE EDGE FINISH

please separate each item with a dash

drawer pull options

MODEL DESCRIPTION

FL Full

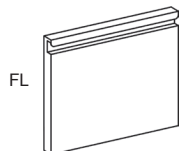

Market Series

bridge, credenza, corner units

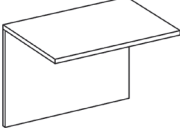
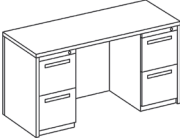
DESCRIPTION	ITEM #	D	W	H	3MM EDGE	SHIP WT.	LEAD TIME*
Bridge for use between two desks 	MK-SUB3624R	24"	36"	28 3/4"	\$718	58	S
	MK-SUB4224R	24"	42"	28 3/4"	\$738	62	S
	MK-SUB4824R	24"	48"	28 3/4"	\$788	70	S
Kneespace Credenza full height, 22 1/4" D fff pedestal 	MK-SCK6024-FP	24"	60"	28 3/4"	\$2334	230	S
	MK-SCK6624-FP	24"	66"	28 3/4"	\$2398	240	S
	MK-SCK7224-FP	24"	72"	28 3/4"	\$2478	250	S

to order

1. Item Number
2. Pull Style
3. Paint Finish
4. Laminate
5. Edge Finish

example

MK-SUB3624R - FL - 5503 - HS - 4072

ITEM NUMBER PULL STYLE PAINT FINISH LAMINATE EDGE FINISH

please separate each item with a dash

drawer pull options

MODEL DESCRIPTION

FL Full

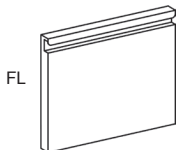

FL

Market Series

D-shape conferencing desk & peninsula

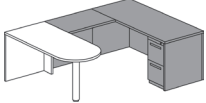
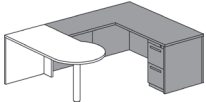
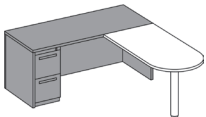
DESCRIPTION	ITEM #	D	W	H	3MM EDGE	SHIP WT.	LEAD TIME*
D-Shape Conferencing Desk for use with bridge units 	MK-SCD6030	30"	60"	28 ¾"	\$1404	102	S
	MK-SCD6630	30"	66"	28 ¾"	\$1448	108	S
	MK-SCD7230	30"	72"	28 ¾"	\$1498	114	S
P-Shape Conferencing Desk for use with bridge units 	MK-SCP7242	42"	72"	28 ¾"	\$1768	125	S
D-Shape Conferencing Return for use w/ 72", 66" or 60" single ped desks 	MK-SCR6030	30"	60"	28 ¾"	\$900	66	S
	MK-SCR6630	30"	66"	28 ¾"	\$948	71	S
	MK-SCR7230	30"	72"	28 ¾"	\$990	77	S

to order

1. Item Number
2. Pull Style
3. Paint Finish
4. Laminate
5. Edge Finish

example

MK-SCD6030 - FL - 5503 - HS - 4072

ITEM NUMBER PULL STYLE PAINT FINISH LAMINATE EDGE FINISH

please separate each item with a dash

drawer pull options

MODEL DESCRIPTION

FL Full

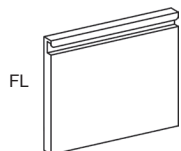

FL

Market Series

overstorage units and tackboards

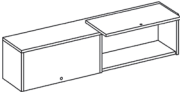
DESCRIPTION	ITEM #	NOTE	COM	D	W	H	PRICE	SHIP WT.	LEAD TIME*
Wall Mounted Overstorage Cabinet w/ doors that stow on unit top 	MK-WM30	Includes mounting hardware		14"	30"	15 ½"	\$962	56	S
	MK-WM36	Includes mounting hardware		14"	36"	15 ½"	\$988	61	S
	MK-WM42	Includes mounting hardware		14"	42"	15 ½"	\$1000	66	S
	MK-WM48	Includes mounting hardware		14"	48"	15 ½"	\$1012	70	S
	MK-WM60	Includes mounting hardware		14"	60"	15 ½"	\$1484	89	S
	MK-WM66**	Includes mounting hardware		14"	66"	15 ½"	\$1950	96	S
	MK-WM72**	Includes mounting hardware		14"	72"	15 ½"	\$1976	103	S
Wall Mounted Tackboards for overstorage cabinet	MK-SFT3019	Includes mounting hardware	2 YD	1"	30"	22 ½"	\$810	28	S
	MK-SFT3619	Includes mounting hardware	2 YD	1"	36"	22 ½"	\$832	38	S
	MK-SFT4219	Includes mounting hardware	2 YD	1"	42"	22 ½"	\$844	42	S
	MK-SFT4819	Includes mounting hardware	2 YD	1"	48"	22 ½"	\$858	48	S
	MK-SFT6019	Includes mounting hardware	2 YD	1"	60"	22 ½"	\$938	68	S
	MK-SFT6619	Includes mounting hardware	2 YD	1"	66"	22 ½"	\$958	74	S
	MK-SFT7219	Includes mounting hardware	2.5 YD	1"	72"	22 ½"	\$992	80	S

to order

1. Item Number
2. Paint Finish
3. Fabric (for tackboards only)

example

MK-SFT3019 - 5503 -

ITEM NUMBER PAINT FINISH FABRIC/COM

please separate each item with a dash

**MK-WM66 ships as (1) 30" w and (1) 36" w units

**MK-WM72 ships as (2) 36" w units

Market Series

desking accessories

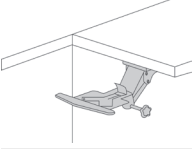
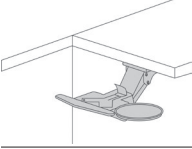
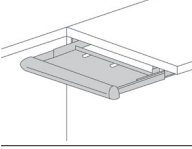
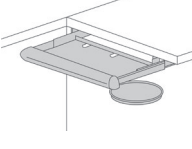
DESCRIPTION	ITEM #	NOTE	PRICE	SHIP WT.	LEAD TIME*
Keyboard Arm 	KB1	Swivels 360 degrees, tils w/ 6" height adjustments Includes wrist rest	\$428	10	S
Keyboard Arm w/ mouse pad 	KB2	Swivels 360 degrees, tils w/ 6" height adjustments Includes wrist rest & mouse pad, for use on left or right	\$484	12	S
Keyboard Tray 	KD1	Steel platform w/ cushion palm rest Steel ball bearing slides	\$634	9	S
Keyboard Tray w/ mouse pad 	KD2	Steel platform w/ cushion palm rest Steel ball bearing slides & mouse pad for use on left or right	\$368	10	S
Box Drawer Divider	HABDD		\$66	4	S
Pedestal Side-to-Side File Bar	HASFB		\$62	4	S
Pencil Tray	MAP1	Black Only	\$62	1	S
24" W Task Light	MTL24		\$248	5.5	S
48" W Task Light	MTL48		\$274	7	S
Center Drawer	CD27	23" D, Specify finish	\$336	5	S

to order	1. Item Number	example	KB1
			ITEM NUMBER

Market Series

introduction - instruction zone

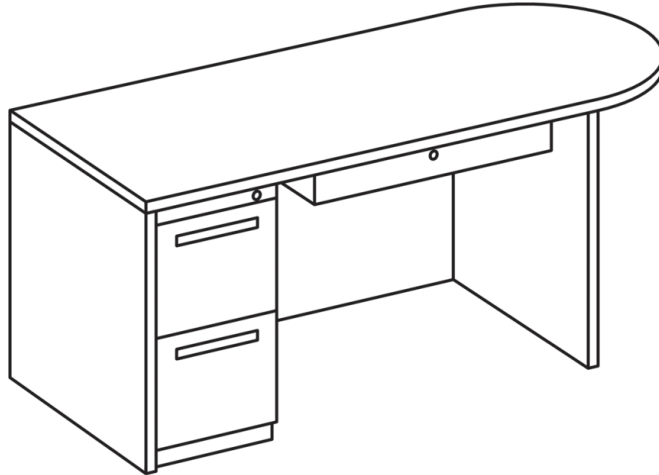

General

All Market Series Desking Units are 28 ¾" H. All worksurfaces are laminate wood core tops at 1 ¾" thick and are available with a 3mm edge. Pedestals lock individually.

Locks

Market Desks come standard with a removable core lock for easy reconfiguration on site. Units can be keyed alike to other Haskell products upon request.

Keying Information and Locking Options

All locks feature a removable core which is easily removed on site. All lock cores are interchangeable through all products as cores are universal.

Locks throughout an order or locks within a particular workstation can be keyed alike at no additional charge if specified when ordering. Keyed Alike means that all locks are identical. To order, specify which products are to be keyed alike and order a "Removable Core Lock Kit" for each group of products to be keyed alike. The specified products will be shipped without lock cores. The cores for each workstation will be packaged separately. All Removable Core Lock Kits are shipped with a control key for removing or inserting lock cores. Note that a control key works only when a lock is in the unlocked position.

Master keys, which operate any removable core, lock are available for \$35 net each.

One control key is provided for each "key alike" order. If additional keys are needed, cost is \$35 net each.

Additional keys can be purchased for \$15 net per key.

Market Series

D-shape educator desk - left

DESCRIPTION	ITEM #	D	W	H	3MM EDGE	SHIP WT.	LEAD TIME*
D-Shape Educators Desk 28 3/4" D f/f pedestal, locks & center drawer	MK-SED6630FL-FF	30"	66"	28 3/4"	\$2424	180	S
	MK-SED7230FL-FF	30"	72"	28 3/4"	\$2508	190	S
D-Shape Educators Desk 28 3/4" D b/b/f pedestal, locks & center drawer	MK-SED6630BL-BBF	30"	66"	28 3/4"	\$2424	180	S
	MK-SED7230BL-BBF	30"	72"	28 3/4"	\$2588	190	S



to order

1. Item Number
2. Pull Style
3. Paint Finish
4. Laminate
5. Edge Finish

example

MK-SED6630FL-FF - FL - 5503 - HS - 4072

ITEM NUMBER PULL STYLE PAINT FINISH LAMINATE EDGE FINISH

please separate each item with a dash

drawer pull options

MODEL DESCRIPTION

FL Full

FL

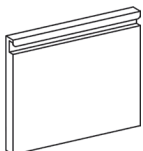

Smart Series

introduction - desking



General

All Smart Desking Units are 29 1/8" H. All worksurfaces are laminate wood core tops at 1 3/16" thick and are available with a 3mm edge. Select Smart Desks are available with locking central drawers and will be noted in product descriptions. Pedestals lock individually. Overstorage units are constructed with a single wall steel back panel with a fabric tackboard insert on front. Overstorage units are available with flipper doors or open shelves.

Locks

Smart Desks come standard with a removable core lock for easy reconfiguration on site. Units can be keyed alike to other Haskell products upon request. Central locking is available on desks 66" in width or less.

Installation

Correct installation should include proper leveling.

Application Considerations

When specifying the units for workstation configurations, note the following points:

- *24" D returns are used for the 66" x 30" or wider single pedestal desks.
- *Overstorage Units can not be used on 36" D with overhangs. The 6" overhang is not suitable to support a loaded overstorage unit.

COM

All COM yardage is based on a 54" wide fabric.

Keying Information and Locking Options

All locks feature a removable core which is easily removed on site. All lock cores are interchangeable through all products as cores are universal.

Locks throughout an order or locks within a particular workstation can be keyed alike at no additional charge if specified when ordering. Keyed Alike means that all locks are identical. To order, specify which products are to be keyed alike and order a "Removable Core Lock Kit" for each group of products to be keyed alike. The specified products will be shipped without lock cores. The cores for each workstation will be packaged separately. All Removable Core Lock Kits are shipped with a control key for removing or inserting lock cores. Note that a control key works only when a lock is in the unlocked position.



Master keys, which operate any removable core, lock are available for \$35 net each.

One control key is provided for each "key alike" order. If additional keys are needed, cost is \$35 net each.

Additional keys can be purchased for \$15 net per key.

Smart Series

double pedestal desks

DESCRIPTION	ITEM #	D	W	H	3MM EDGE	SHIP WT.	LEAD TIME*
Double Pedestal Desk full height, 28¼" D pedestals, locks & center drawer 	SDC6030FP-BBF-FF	30"	60"	29"	\$2720	236	E
	SDC6630FP-BBF-FF	30"	66"	29"	\$2768	253	E
	SDC7230FP-BBF-FF	30"	72"	29"	\$2820	265	E
Double Pedestal Desk full height, 28¼" D pedestals & locks 	SD6030FP-BBF-FF	30"	60"	29"	\$2560	236	E
	SD6630FP-BBF-FF	30"	66"	29"	\$2600	253	E
	SD7230FP-BBF-FF	30"	72"	29"	\$2640	265	E
Double Pedestal Desk full height, 28¼" D pedestals, end panels & locks 	SD6030EP-BBF-FF-24	30"	60"	29"	\$2816	231	E
	SD6630EP-BBF-FF-24	30"	66"	29"	\$2864	251	E
	SD7230EP-BBF-FF-24	30"	72"	29"	\$3098	263	E

to order

1. Item Number
2. Pull Style
3. Paint Finish
4. Laminate
5. Edge Finish
6. Options

example

SDC6030EP-BF - FL - 5503 - HS - 4072 - CL

ITEM NUMBER PULL STYLE PAINT FINISH LAMINATE EDGE FINISH OPTIONS

please separate each item with a dash

drawer pull options

MODEL DESCRIPTION

FL Full

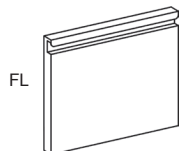

FL

Smart Series

bow front double pedestal desks

DESCRIPTION	ITEM #	D	W	H	3MM EDGE	SHIP WT.	LEAD TIME*
Bow Front Double Pedestal Desk	SDC6648FP-BOW	48"	66"	29"	\$3182	273	E
full height, 28 3/4" D pedestals, locks & center drawer	SDC7248FP-BOW	48"	72"	29"	\$3476	285	E
Bow Front Double Pedestal Desk	SD6648FP-BOW	48"	66"	29"	\$2924	273	E
full height, 28 3/4" D pedestals & locks	SD7248FP-BOW	48"	72"	29"	\$3218	285	E



to order

1. Item Number
2. Pull Style
3. Paint Finish
4. Laminate
5. Edge Finish
6. Options

example

SDC6648FP-BOW - FL - 5503 - HS - 4072 - CL

ITEM NUMBER PULL STYLE PAINT FINISH LAMINATE EDGE FINISH OPTIONS

please separate each item with a dash

drawer pull options

MODEL	DESCRIPTION
FL	Full

central locking options

MODEL	DESCRIPTION	PRICE
CL	Central locking is available on desks 66" in width or less	\$132

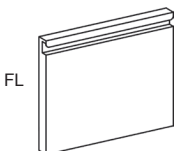

FL

Smart Series

single pedestal desks - right

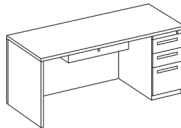
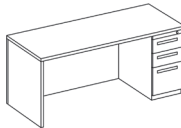
DESCRIPTION	ITEM #	D	W	H	3MM EDGE	SHIP WT.	LEAD TIME*
Single Right Pedestal Desk, locks & center drawer 	SSC6024FP-18-BBF	24"	60"	29"	\$2294	175	E
	SSC6624FP-18-BBF	24"	66"	29"	\$2342	180	E
	SSC7224FP-18-BBF	24"	72"	29"	\$2384	195	E
	SSC4830FP-18-BBF	30"	48"	29"	\$2310	175	E
	SSC6030FP-18-BBF	30"	60"	29"	\$2358	185	E
	SSC6630FP-18-BBF	30"	66"	29"	\$2406	210	E
	SSC7230FP-18-BBF	30"	72"	29"	\$2458	235	E
	SSC7236FP-18-BBF	36"	72"	29"	\$2508	240	E
Single Right Pedestal Desk & locks 	SS6024FP-18-BBF	24"	60"	29"	\$2134	170	E
	SS6624FP-18-BBF	24"	66"	29"	\$2182	175	E
	SS7224FP-18-BBF	24"	72"	29"	\$2224	190	E
	SS4830FP-18-BBF	30"	48"	29"	\$2150	170	E
	SS6030FP-18-BBF	30"	60"	29"	\$2182	180	E
	SS6630FP-18-BBF	30"	66"	29"	\$2246	205	E
	SS7230FP-18-BBF	30"	72"	29"	\$2298	220	E
	SS7236FP-18-BBF	36"	72"	29"	\$2348	235	E

to order

1. Item Number
2. Pull Style
3. Paint Finish
4. Laminate
5. Edge Finish

example

SSC4830R - FL - 5503 - HS - 4072

ITEM NUMBER PULL STYLE PAINT FINISH LAMINATE EDGE FINISH

please separate each item with a dash

drawer pull options

MODEL	DESCRIPTION
FL	Full

FL

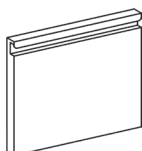

specification note

Haskell offers 22¼" depth pedestals on 24" depth desks.
Haskell offers 28¼" depth pedestals on 30" & 36" depth desks.

Smart Series

single pedestal desks - left

DESCRIPTION	ITEM #	D	W	H	3MM EDGE	SHIP WT.	LEAD TIME*
Single Left Pedestal Desk, locks & center drawer 	SSC6024FP-12-BBF	24"	60"	29"	\$2294	175	E
	SSC6624FP-12-BBF	24"	66"	29"	\$2342	180	E
	SSC7224FP-12-BBF	24"	72"	29"	\$2384	195	E
	SSC4830FP-12-BBF	30"	48"	29"	\$2310	175	E
	SSC6030FP-12-BBF	30"	60"	29"	\$2358	185	E
	SSC6630FP-12-BBF	30"	66"	29"	\$2406	210	E
	SSC7230FP-12-BBF	30"	72"	29"	\$2458	235	E
	SSC7236FP-12-BBF	36"	72"	29"	\$2508	240	E
Single Left Pedestal Desk & locks 	SS6024FP-12-BBF	24"	60"	29"	\$2134	170	E
	SS6624FP-12-BBF	24"	66"	29"	\$2182	175	E
	SS7224FP-12-BBF	24"	72"	29"	\$2224	190	E
	SS4830FP-12-BBF	30"	48"	29"	\$2150	170	E
	SS6030FP-12-BBF	30"	60"	29"	\$2182	180	E
	SS6630FP-12-BBF	30"	66"	29"	\$2246	205	E
	SS7230FP-12-BBF	30"	72"	29"	\$2298	220	E
	SS7236FP-12-BBF	36"	72"	29"	\$2348	235	E

to order

1. Item Number
2. Pull Style
3. Paint Finish
4. Laminate
5. Edge Finish

example

SSC4830L - FL - 5503 - HS - 4072

ITEM NUMBER PULL STYLE PAINT FINISH LAMINATE EDGE FINISH

please separate each item with a dash

drawer pull options

MODEL DESCRIPTION

FL Full

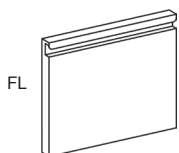

FL

specification note

Haskell offers 22¼" depth pedestals on 24" depth desks.

Haskell offers 28¼" depth pedestals on 30" & 36" depth desks.

Smart Series

desk & return shells

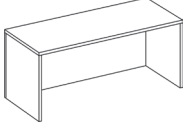
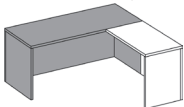
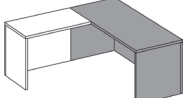
DESCRIPTION	ITEM #	D	W	H	3MM EDGE	SHIP WT.	LEAD TIME*
Desk Shell accommodates right or left return 	DS4824	24"	48"	29"	\$1348	107	E
	DS6024	24"	60"	29"	\$1368	121	E
	DS6624	24"	66"	29"	\$1378	129	E
	DS7224	24"	72"	29"	\$1388	149	E
	DS4830	30"	48"	29"	\$1368	118	E
	DS6030	30"	60"	29"	\$1408	133	E
	DS6630	30"	66"	29"	\$1438	144	E
	DS7230	30"	72"	29"	\$1478	154	E
	DS7236	36"	72"	29"	\$1588	165	E
Return Shell - right 	SR3624-18	24"	36"	29"	\$1018	71	E
	SR4224-18	24"	42"	29"	\$1032	71	E
	SR4824-18	24"	48"	29"	\$1068	77	E
	SR6024-18	24"	60"	29"	\$1088	88	E
Return Shell - left 	SR3624-12	24"	36"	29"	\$1018	71	E
	SR4224-12	24"	42"	29"	\$1032	71	E
	SR4824-12	24"	48"	29"	\$1068	77	E
	SR6024-12	24"	60"	29"	\$1088	88	E

to order

1. Item Number
2. Pull Style
3. Paint Finish
4. Laminate
5. Edge Finish

example

DS4824 - FL - 5503 - HS - 4072

ITEM NUMBER PULL STYLE PAINT FINISH LAMINATE EDGE FINISH

please separate each item with a dash

drawer pull options

MODEL DESCRIPTION

FL Full

FL

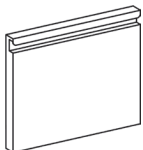

Smart Series

pedestal returns

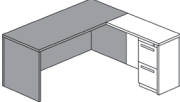
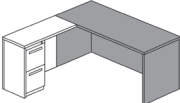
DESCRIPTION	ITEM #	D	W	H	3MM EDGE	SHIP WT.	LEAD TIME*
 Right Pedestal Return full height, 22¼" D fff pedestal	SPR3624FP-18-FF	24"	36"	29"	\$1490	120	E
	SPR4224FP-18-FF	24"	42"	29"	\$1500	126	E
	SPR4824FP-18-FF	24"	48"	29"	\$1638	132	E
	SPR6024FP-18-FF	24"	60"	29"	\$1678	140	E
 Left Pedestal Return full height, 22¼" D fff pedestal	SPR3624FP-12-FF	24"	36"	29"	\$1490	120	E
	SPR4224FP-12-FF	24"	42"	29"	\$1500	126	E
	SPR4824FP-12-FF	24"	48"	29"	\$1638	132	E
	SPR6024FP-12-FF	24"	60"	29"	\$1678	140	E

to order

1. Item Number
2. Pull Style
3. Paint Finish
4. Laminate
5. Edge Finish

example

SPR4824FP-18-FF - FL - 5503 - HS - 4072

ITEM NUMBER PULL STYLE PAINT FINISH LAMINATE EDGE FINISH

please separate each item with a dash

drawer pull options

MODEL DESCRIPTION

FL Full

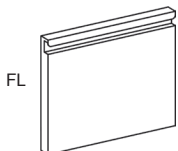

FL

Smart Series

bridge, credenza

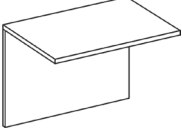
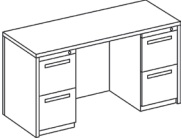
DESCRIPTION	ITEM #	D	W	H	3MM EDGE	SHIP WT.	LEAD TIME*
Bridge for use between two desks 	SUB3624R	24"	36"	29"	\$814	58	E
	SUB4224R	24"	42"	29"	\$834	62	E
	SUB4824R	24"	48"	29"	\$856	70	E
Kneespace Credenza full height, 22 1/4" D ff pedestals 	SCK6024-FP	24"	60"	29"	\$2558	230	E
	SCK6624-FP	24"	66"	29"	\$2606	240	E
	SCK7224-FP	24"	72"	29"	\$2654	250	E

to order

1. Item Number
2. Pull Style
3. Paint Finish
4. Laminate
5. Edge Finish

example

SUB3624R - FL - 5503 - HS - 4072

ITEM NUMBER PULL STYLE PAINT FINISH LAMINATE EDGE FINISH

please separate each item with a dash

drawer pull options

MODEL DESCRIPTION

FL Full

FL

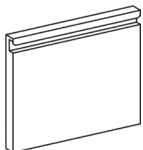

Smart Series

D-shape conferencing desk & peninsula

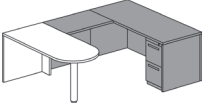
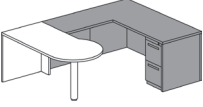
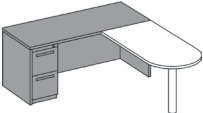
DESCRIPTION	ITEM #	D	W	H	3MM EDGE	SHIP WT.	LEAD TIME*
D-Shape Conferencing Desk for use with bridge units 	SCD6030	30"	60"	29"	\$1404	102	E
	SCD6630	30"	66"	29"	\$1448	108	E
	SCD7230	30"	72"	29"	\$1498	114	E
P-Shape Conferencing Desk for use with bridge units 	SCP7242	42"	72"	29"	\$1768	125	E
D-Shape Conferencing Return for use w/ 72", 66" or 60" single ped desks 	SCR6030	30"	60"	29"	\$900	66	E
	SCR6630	30"	66"	29"	\$948	71	E
	SCR7230	30"	72"	29"	\$990	77	E

to order

1. Item Number
2. Pull Style
3. Paint Finish
4. Laminate
5. Edge Finish

example

SCP6030 - FL - 5503 - HS - 4072
ITEM NUMBER PULL STYLE PAINT FINISH LAMINATE EDGE FINISH
please separate each item with a dash

drawer pull options

MODEL DESCRIPTION

FL Full

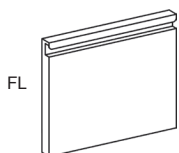

FL

Smart Series

overstorage units and tackboards

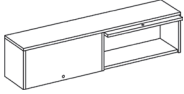
DESCRIPTION	ITEM #	NOTE	COM	D	W	H	PRICE	SHIP WT.	LEAD TIME*
Wall Mounted Overstorage Cabinet 	WM30	Includes mounting hardware		14"	30"	15 ½"	\$962	56	E
	WM36	Includes mounting hardware		14"	36"	15 ½"	\$988	61	E
	WM42	Includes mounting hardware		14"	42"	15 ½"	\$1000	66	E
	WM48	Includes mounting hardware		14"	48"	15 ½"	\$1012	70	E
	WM60	Includes mounting hardware		14"	60"	15 ½"	\$1484	89	E
	WM66**	Includes mounting hardware		14"	66"	15 ½"	\$1950	96	E
	WM72**	Includes mounting hardware		14"	72"	15 ½"	\$1976	103	E
Wall Mounted Tackboards for overstorage cabinet	SFT3019	Includes mounting hardware	2 YD	1"	30"	22 ½"	\$810	28	E
	SFT3619	Includes mounting hardware	2 YD	1"	36"	22 ½"	\$832	38	E
	SFT4219	Includes mounting hardware	2 YD	1"	42"	22 ½"	\$844	42	E
	SFT4819	Includes mounting hardware	2 YD	1"	48"	22 ½"	\$858	48	E
	SFT6019	Includes mounting hardware	2 YD	1"	60"	22 ½"	\$938	68	E
	SFT6619	Includes mounting hardware	2 YD	1"	66"	22 ½"	\$958	74	E
	SFT7219	Includes mounting hardware	2.5 YD	1"	72"	22 ½"	\$992	80	E

to order

1. Item Number
2. Paint Finish
3. Fabric (for tackboards only)

example

SOS3619TB - 5503 -

ITEM NUMBER PAINT FINISH FABRIC/COM

please separate each item with a dash

**WM66 ships as (1) 30" w and (1) 36" w units

**WM72 ships as (2) 36" w units

Smart Series

desking accessories

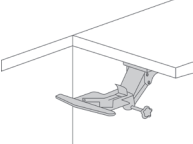
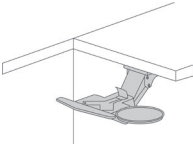
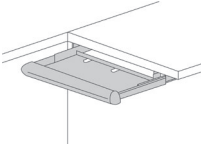
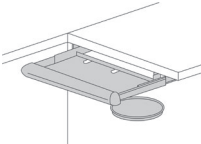
DESCRIPTION	ITEM #	NOTE	PRICE	SHIP WT.	LEAD TIME*
Keyboard Arm 	KB1	Swivels 360 degrees, tils w/ 6" height adjustments Includes wrist rest	\$428	10	S
Keyboard Arm w/ mouse pad 	KB2	Swivels 360 degrees, tils w/ 6" height adjustments Includes wrist rest & mouse pad, for use on left or right	\$484	12	S
Keyboard Tray 	KD1	Steel platform w/ cushion palm rest Steel ball bearing slides	\$634	9	S
Keyboard Tray w/ mouse pad 	KD2	Steel platform w/ cushion palm rest Steel ball bearing slides & mouse pad for use on left or right	\$368	10	S
Box Drawer Divider	HABDD		\$66	4	S
Pedestal Side-to-Side File Bar	HASFB		\$62	4	S
Pencil Tray	MAP1	Black Only	\$62	1	S
24" W Task Light	MTL24		\$248	5.5	S
48" W Task Light	MTL48		\$274	7	S
Center Drawer	CD27	23" D, Specify finish	\$336	5	S

to order

1. Item Number

example

KB1

ITEM NUMBER

Smart Series

introduction - instruction zone

General

All Smart Desking Units are 29 1/8" H. All worksurfaces are laminate wood core tops at 1 3/16" thick and are available with a 3mm edge. Select Smart Desks are available with locking central drawers and will be noted in product descriptions. Pedestals lock individually. Overstorage units are constructed with a single wall steel back panel with a fabric tackboard insert on front. Overstorage units are available with flipper doors or open shelves.

Locks

Smart Desks come standard with a removable core lock for easy reconfiguration on site. Units can be keyed alike to other Haskell products upon request. Central locking is available on desks 66" in width or less.

Installation

Correct installation should include proper leveling.

Application Considerations

When specifying the units for workstation configurations, note the following points:

*24" D returns are used for the 66" x 30" or wider single pedestal desks.

*Overstorage Units can not be used on 36" D with overhangs. The 6" overhang is not suitable to support a loaded overstorage unit.

COM

All COM yardage is based on a 54" wide fabric.

Keying Information and Locking Options

All locks feature a removable core which is easily removed on site. All lock cores are interchangeable through all products as cores are universal.

Locks throughout an order or locks within a particular workstation can be keyed alike at no additional charge if specified when ordering. Keyed Alike means that all locks are identical. To order, specify which products are to be keyed alike and order a "Removable Core Lock Kit" for each group of products to be keyed alike. The specified products will be shipped without lock cores. The cores for each workstation will be packaged separately. All Removable Core Lock Kits are shipped with a control key for removing or inserting lock cores. Note that a control key works only when a lock is in the unlocked position.

Master keys, which operate any removable core, lock are available for \$35 net each.

One control key is provided for each "key alike" order. If additional keys are needed, cost is \$35 net each.

Additional keys can be purchased for \$15 net per key.

Smart Series

D-shape educator desk - right

DESCRIPTION	ITEM #	D	W	H	3MM EDGE	SHIP WT.	LEAD TIME*
D-Shape Educators Desk 28¼" D f/f pedestal, locks & center drawer	SEDC6630FR-FF	30"	66"	29"	\$2424	180	E
	SEDC7230FR-FF	30"	72"	29"	\$2508	190	E
D-Shape Educators Desk 28¼" D b/b/f pedestal, locks & center drawer	SEDC6630BR-BBF	30"	66"	29"	\$2458	180	E
	SEDC7230BR-BBF	30"	72"	29"	\$2588	190	E
D-Shape Educators Desk 28¼" D f/f pedestal, bookcase, locks & center drawer	SEDC7230FCR-FF	30"	72"	29"	\$3412	260	E
D-Shape Educators Desk 28¼" D b/b/f pedestal, bookcase, locks & center drawer	SEDC7230BCR-BBF	30"	72"	29"	\$3552	260	E



to order

1. Item Number
2. Pull Style
3. Paint Finish
4. Laminate
5. Edge Finish

example

SEDC6630FR-FF - FL - 5503 - HS - 4072

ITEM NUMBER PULL STYLE PAINT FINISH LAMINATE EDGE FINISH

please separate each item with a dash

drawer pull options

MODEL DESCRIPTION

FL Full

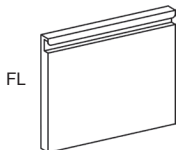

FL

Smart Series

D-shape educator desk - left

DESCRIPTION	ITEM #	D	W	H	3MM EDGE	SHIP WT.	LEAD TIME*
D-Shape Educators Desk 28¼" D f/f pedestal, locks & center drawer	SED6630FL-FF	30"	66"	29"	\$2424	180	E
	SED7230FL-FF	30"	72"	29"	\$2508	190	E
D-Shape Educators Desk 28¼" D b/b/f pedestal, locks & center drawer	SED6630BL-BBF	30"	66"	29"	\$2458	180	E
	SED7230BL-BBF	30"	72"	29"	\$2588	190	E
D-Shape Educators Desk 28¼" D f/f pedestal, bookcase, locks & center drawer	SED7230FCL-FF	30"	72"	29"	\$3412	260	E
D-Shape Educators Desk 28¼" D b/b/f pedestal, bookcase, locks & center drawer	SED7230BCL-BBF	30"	72"	29"	\$3552	260	E

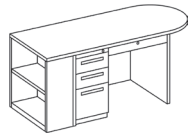
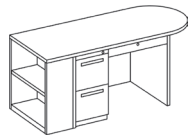
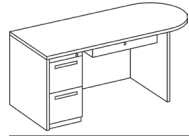

to order	1. Item Number	SED6630FL-FF - FL - 5503 - HS - 4072				
	2. Pull Style	ITEM NUMBER	PULL STYLE	PAINT FINISH	LAMINATE	EDGE FINISH
	3. Paint Finish	<i>please separate each item with a dash</i>				
4. Laminate						
5. Edge Finish						

drawer pull options

MODEL DESCRIPTION

FL Full

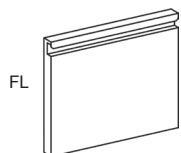

Voyager Series

introduction



Voyager Series

adjustable ht. butcher block table

DESCRIPTION	ITEM #	D	W	H	PRICE	SHIP WT.	LEAD TIME*
-------------	--------	---	---	---	-------	----------	------------

Voyager table, 36d x 60w, butcher block top and locking casters. Adjustable Height, no storage options. Platinum frame only.

VY1.3660.P2

36" 60" 30"-40"

\$2230

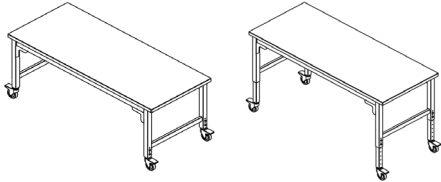

Voyager table, 36d x 72w, butcher block top and locking casters. Adjustable height, no storage options. Platinum frame only.

VY1.3672.P2

36" 72" 30"-40"

\$2480

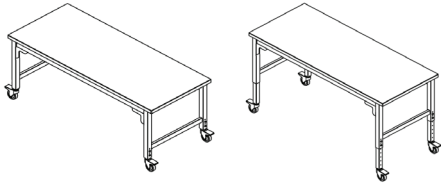

to order

1. Item Number

example

MK3.3660.P2

ITEM NUMBER

Voyager Series

adj ht. laminate table

DESCRIPTION	ITEM #	D	W	H	PRICE	SHIP WT.	LEAD TIME*
Voyager table, 36d x 60w, standard laminate top and locking casters. Adjustable Height, no storage options. Platinum frame only.	VY1L.3660.P2	36"	60"	29.25"-39.25"	\$1882		

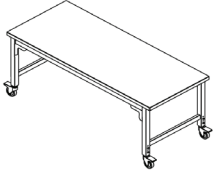
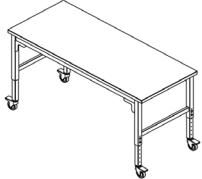
Voyager table, 36d x 72w, standard laminate top and locking casters. Adjustable height, no storage options. Platinum frame only.	VY1L.3672.P2	36"	72"	29.25"-39.25"w	\$1952		
--	--------------	-----	-----	----------------	--------	--	--

to order

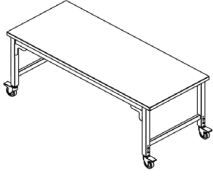
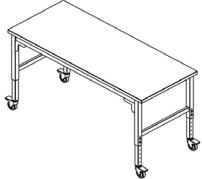
1. Item Number





example

MK3.3660.P2

ITEM NUMBER

Voyager Series

storage carts

DESCRIPTION	ITEM #	D	W	H	PRICE	SHIP WT.	LEAD TIME*
Short Storage Cart w/ 2 shelves, magnetic white board backing & locking casters. Platinum frame.	MBC.3642.P2	19"	36"	42.5"	\$1014		
							
Tall Storage Cart w/ 1 fixed and 2 adjustable shelves, magnetic white board backing & locking casters. Platinum frame.	MBC.4159.P2	19"	41"	59.5"	\$1790		
							
Short Storage Cart w/ 24 - 3" bins, magnetic white board backing & locking casters. Platinum frame.	MBSA8.4142.P2	19"	41"	42.5"	\$1796		
							
Tall Storage Cart w/ 36 - 3" bins, magnetic white board backing & locking casters. Platinum frame.	MBSA12.4159.P2	19"	41"	59.5"	\$2396		
							

to order	1. Item Number	example MK3.3660.P2
		ITEM NUMBER

To order additional bins

MODEL	DESCRIPTION	PRICE EACH
BINPK3	Clear Tote Bin - 3"H x 16.81"L x 12.28"W Pack of 6	\$120.00

Price List

August 2023

8.21.23